

easyfix[®]

**PRODUCT
CATALOGUE**



shop.tannen-paradies.de

easyfix@tannenparadies.de

+49 (0)30 707 83 675

MACHINES

Drilling machine type 4

With our Easyfix drilling machine, you can easily prepare netted or unnetted trees within a few seconds. Simply pull up the net from the trunk, then place the tree in the conical funnel and align it with the height-adjustable spacer bar.

The machine is operated with the foot pedal, so you can easily hold larger trees with both hands. Only a short step down is necessary to drill the tree vertically.

Spare parts available online at:
shop.tannen-paradies.de.

Easyfix drilling machine type 4, 230 V, 2.0 KW, 6500 r/min.

Item.-no.: 44640



Equipment

Drillbit, HSS TIN steel, 16 mm

Item.-no.: 44722

Drill chuck for drilling machine type 4, 34 mm Ø, improved splint removal

Item.-no.: 44733-4n

1m stainless steel rod to extend the distance pole of the drilling machine. Allows to drill trees up to 3.3 meters.

Steel rod, extension bar for Easyfix drilling machine, 1 m

Item.-no.: 44747v

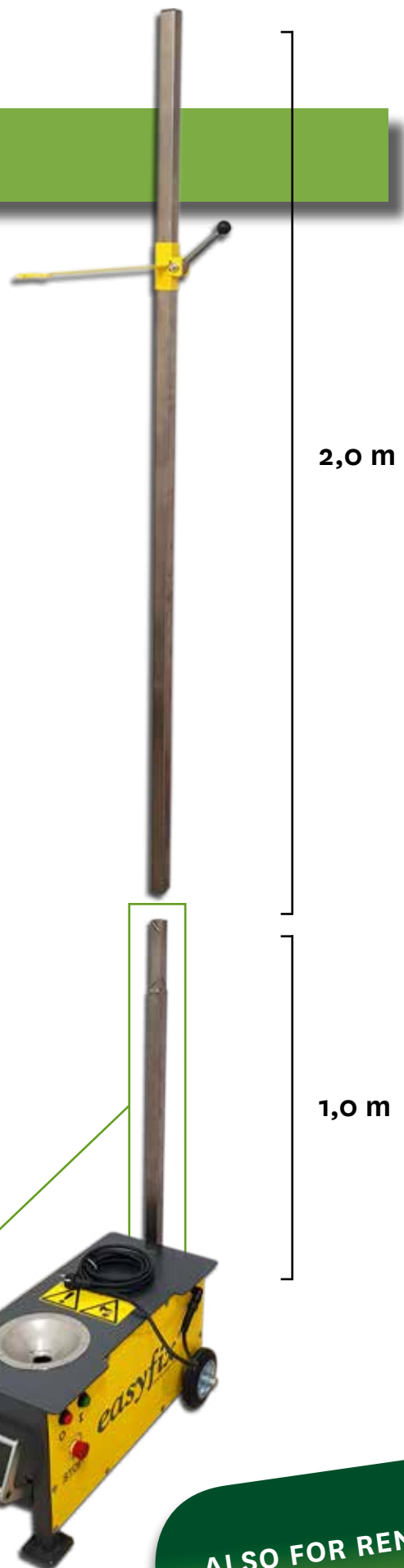

* **All prices excluding VAT.** The machine must be returned to us by February 15th of the following year at the latest. The customer bears the transport costs for this. When purchasing the machine one rent can be credited to the purchase price.

Tree shaker

Machine for removing water or snow as well as dry needles and leaves from the Christmas tree. Simply lift the tree onto the funnel and operate the machine using the foot pedal. Suitable for use before netting or palletizing the tree. The shaking process can easily be carried out with one hand in a few seconds.

Baumschüttelmaschine 230 V / 1,5 KW

Item-no.: 44800



Hydraulic drilling machine

With the hydraulically driven drilling machine, trees can be drilled directly in the plantation before being netted. For operation, the machine has to be connected to the corresponding hydraulic joints on a tractor (length hydraulic hose 2,3 m / length electric cable 2,8 m). In order to achieve an optimal drilling result, flow rate should be at least 45 L / min. Optimal air pressure is 180 bar. To drill, place the tree in the conical funnel and align it with the height-adjustable spacer bar. The machine is operated by a foot pedal so that you can hold larger trees with both hands. A short step down is necessary to drill the tree vertically. Suitable suspension for tractor type 1/2 on request.

Hydraulic drilling machine, 180 bar, 45 l/min

Item-no.: 44690

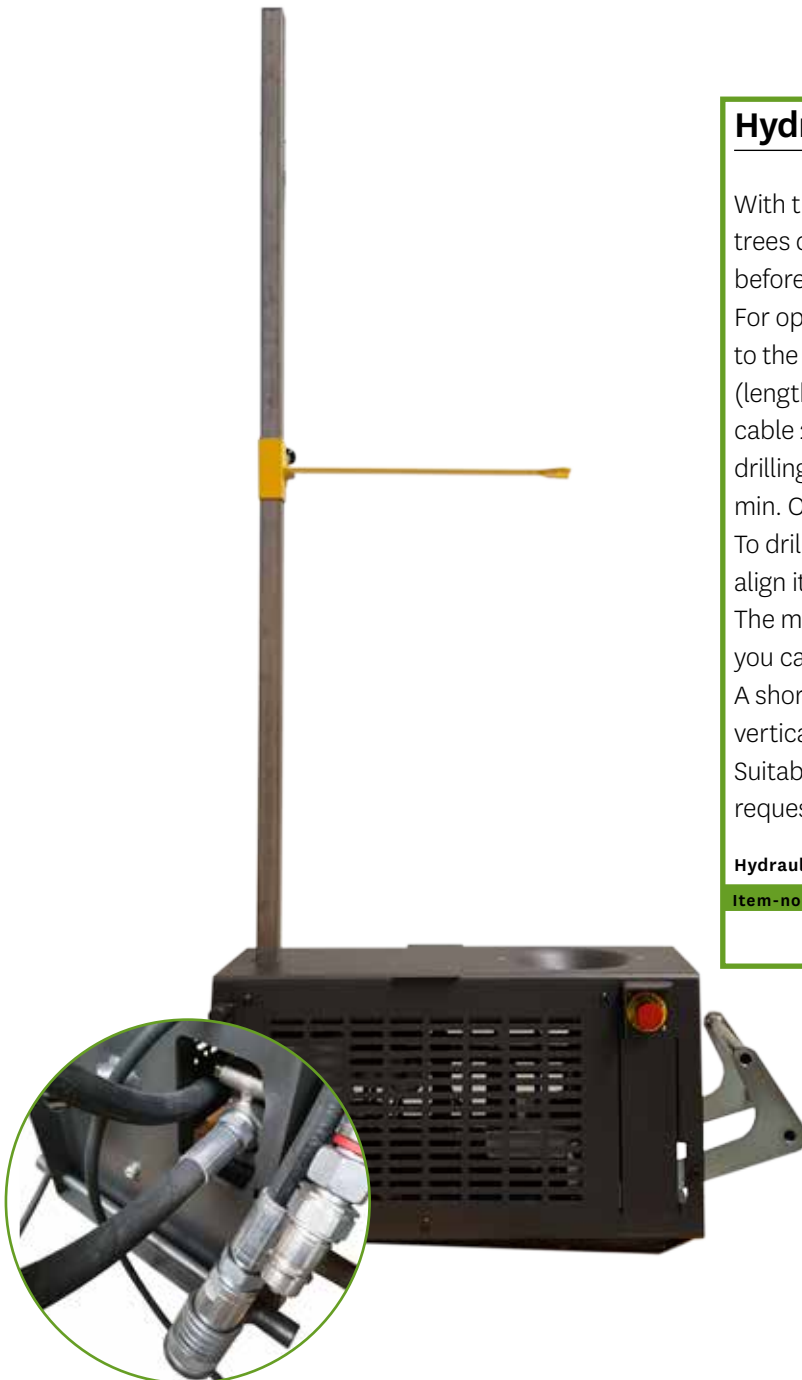

PINS (suitable for customer stands)

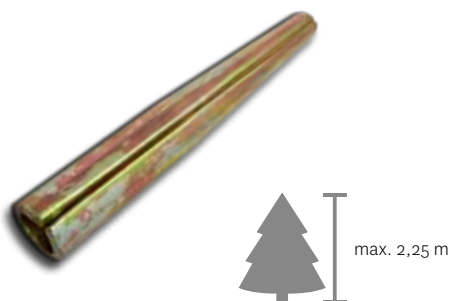

Pin to hammer in

You want to produce your own Christmas tree stands? No problem!

With our pins you can build up your own individualized presentation system yourself.

Pin to hammer in, 122 mm, yellow galvanized

Item-no.: 44422

Pin with thread

Our pin with thread is the ideal way to easily place and present Christmas trees on wooden stands or planks.

Pin with M10 thread, 112 mm, yellow galvanized, incl. captive nut

Item-no.: 44400

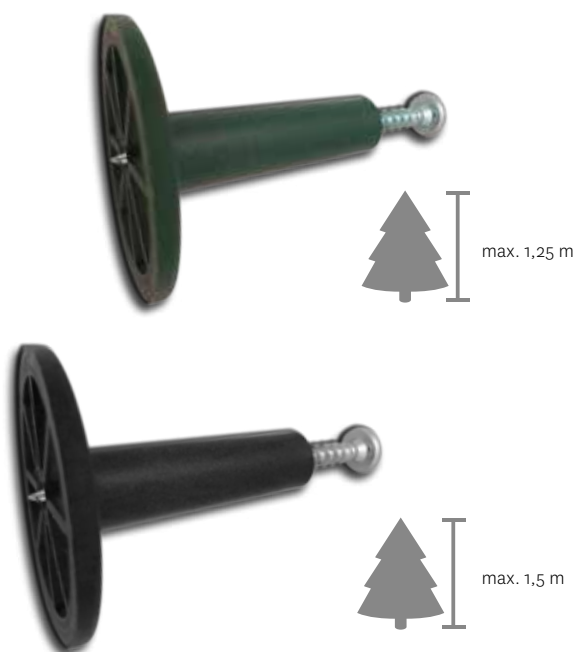

Plastic pin with screw

The plastic pin is ideal for the production of stands for small trees up to 1.25 / 1.5 m. The screw is already pre-screwed. For assembly simply place the pin on top of the selected wooden stand and turn in the screw by using the hexagon socket. Wood thickness has to be at least 22 / 36 mm.

Plastic pin with screw 6 x 80 hexagon socket

Item-no.: 44200-pp

Glass fiber reinforced plastic pin with screw, 6 x 93 hexagon socket

Item-no.: 44200-gf

PINS (suitable for presentation)

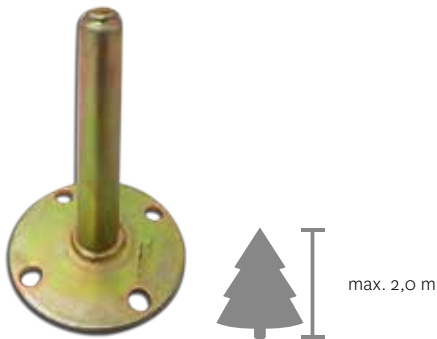

Pin with round plate

The pin with round plate of 68 mm in diameter is made of high quality steel and galvanized especially for outdoor use. A simple and inexpensive way to present trees up to a height of 2 m (for example on pallets or wooden planks).

Pin with round plate 68 x 3 mm, yellow galvanized

Item-no.: 44412



Pin with plate

The pin with base plate of 100 x 100 x 5 mm is made of high-quality steel and galvanized especially for outdoor use. A simple way to present trees up to a height of 2.5 m (for example on pallets or wooden planks).

Pin with plate, 100 x 100 x 5 mm, yellow galvanized

Item-no.: 44410

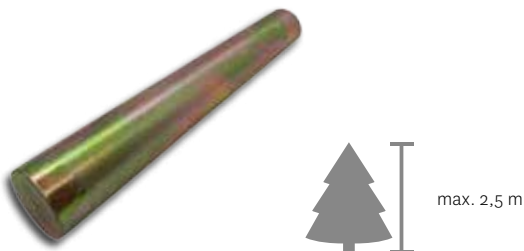

Welding pin

Pin for welding. Galvanized for outdoor use. A simple and inexpensive way to present trees up to a height of 2.5 m.

Welding pin, 83 mm, galvanized

Item-no.: 44423



Ground pin

Pin for hammering into the ground. Galvanized for outdoor use. A simple and inexpensive way to present trees up to a height of 2.2 m.

Ground pin, 470 mm, Ø 29 mm, galvanized

Item-no.: 44430

PRESENTATION STANDS

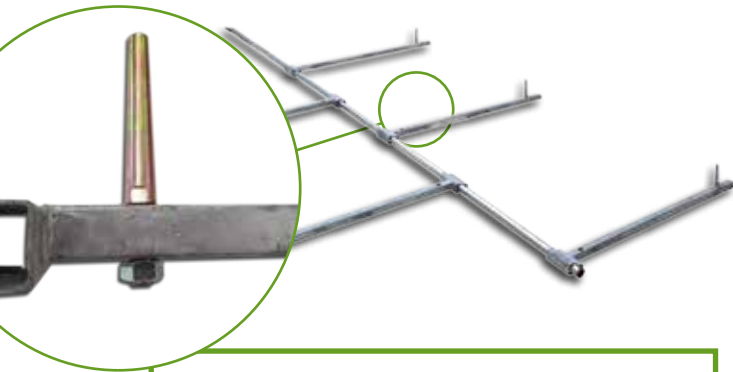

Line Up

Our line up system consists of several 78 cm long, hot-dip galvanized crossbars on a standard 3/4-inch water pipe (outside Ø: 27 mm). Depending on the tree size, the crossbars can be arranged as desired. In that way Christmas trees are presented quickly and accurately in a row. We recommend a maximum tree height of 2 m. Up to a tree height of 1.5 m it is possible to add a middle row with an additional pin to use the given space even more effectively.

„Line up“ stand, 78cm, hot dip galvanized

Item-no.: 44470

„Line up“ guide pipe, 200 cm (outer diameter 27 mm), silver coated

Item-no.: 44471

„Line up“ middle pin, 123 mm, incl. M12 nut

Item-no.: 44452d

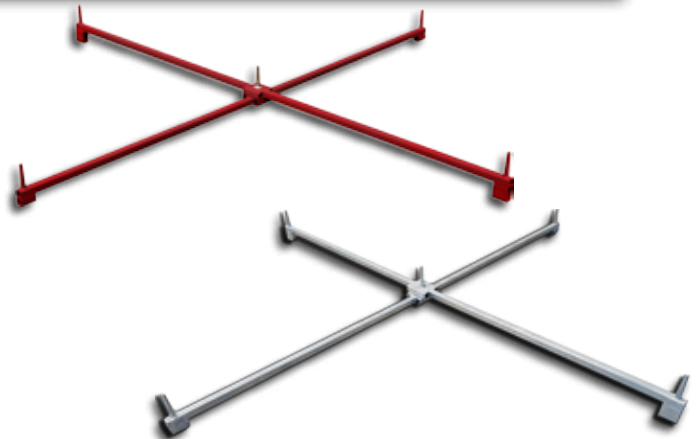

5-pin cross stand

On our stable, powder-coated or hot-dip galvanized cross stands, you can present a maximum of five Christmas trees up to 2.5 m (in wind-protected places even up to 3 m). Foldable for transport and storage.

5-pin cross stand, 200 x 200 cm, red powder coated

Item-no.: 44441

5-pin cross stand, 200 x 200 cm, hot dip galvanized

Item-no.: 44442

5-pin cross stand, 130 x 130 cm, red powder coated

Item-no.: 44443

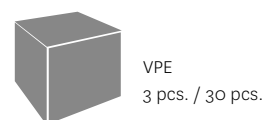
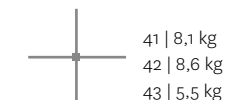
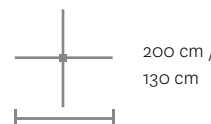
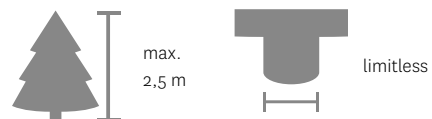
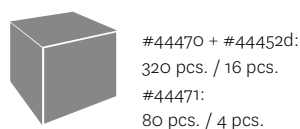
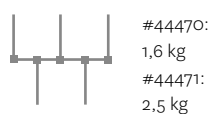
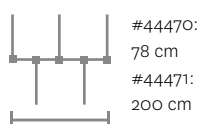



Single stand, non-foldable

Our single stand is ideal for setting up individual trees up to a height of 3 m.

The advantage: Even large trees can be set up without much effort, as the tree can be pinned on while lying.

The rubber coating at the endings ensure a non-slip stand.

Single stand (non-foldable), 78.5 x 78.5 cm, hot dip galvanized

Item-no.: 44450

Single stand (non-foldable), 74.5 x 74.5 cm, black powder coated incl. cross protector & water supplier

Item-no.: 44454



Cross protector & water supplier

Made of high quality plastic, the cross protector provides a water capacity of up to 2 l.

Therefore it ensures longer freshness of the tree and in addition prevents free-standing pins at the place of sale from becoming a risk of accident.

The model can be combined with the following presentation stands:

Item no. 44441-44443*, 44450, 44470 (* cannot be placed on the middle pin)

Cross protector & water supplier, 22 cm, green

Item-no.: 44407

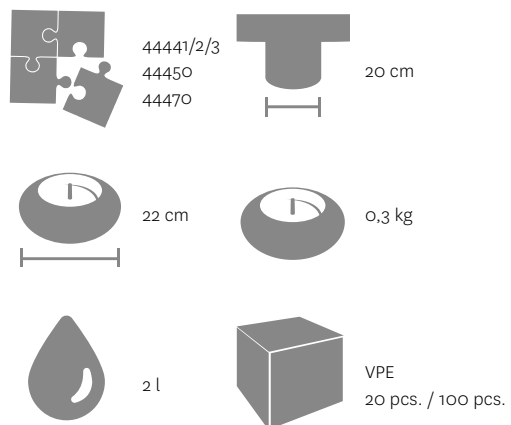
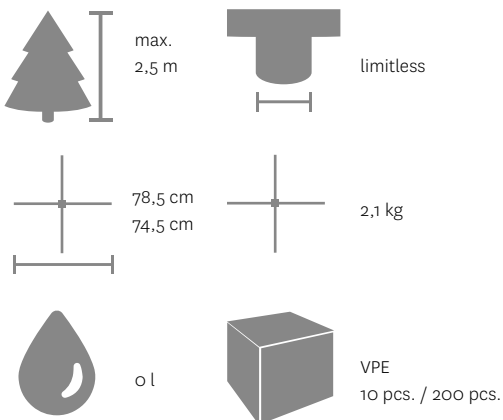

WATERSTANDS



Mini Light

The ideal alternative to the potted tree!
 Made of high quality green recycled plastic, the Mini Light with 23 cm diameter is the smallest water stand of our Easyfix product line.
 Suitable for a maximum tree height of 1.5 m and a trunk width of 12 cm.
 To keep the tree fresh, the stand can be filled with up to 0.5 l of water.

Mini Light, 23 cm, green

Item-no.: 44150

Junior Light

Made of high quality green or black recycled plastic, with a 32 cm diameter.
 Suitable for a maximal tree height of 1.8 m and a trunk width of 14 cm.
 For longer freshness of the plant the stand can be filled with 1.5 l of water.

Junior Light, 32 cm, green

Item-no.: 44143

Junior Light, 32 cm, black

Item-no.: 44145

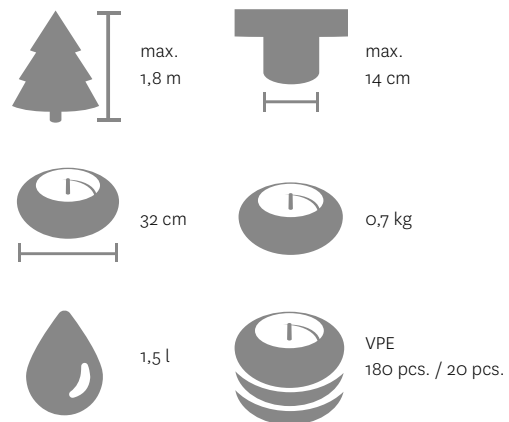
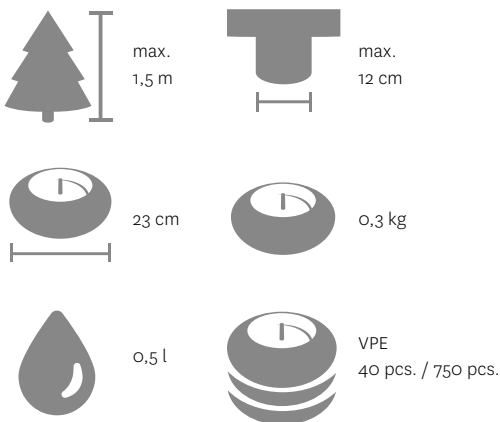



Classic Light

Made of high quality recycled green or black plastic, the Classic Light with a total diameter of 39 cm holds trees up to a height of 2.3 m. With an internal diameter of 22 cm, almost any trunk width is able to fit into the stand. For longer life duration of the tree it can be filled with up to 3 l of water.

Classic Light, 39 cm, green

Item-no.: 44120

Classic Light, 39 cm, black

Item-no.: 44121

Maxi Light

The Maxi Light is the largest plastic water stand. Made from recycled material, it is available in the colours green or black. It's suitable for trees up to a height of 2.7 m and a maximum trunk width of 30 cm. The diameter of 47.5 cm guarantees a secure stand. Thanks to a large water reservoir of up to 8.5 l, the tree stays fresh for a long time.

Maxi Light, 47.5 cm, green

Item-no.: 44160

Maxi Light, 47.5 cm, black

Item-no.: 44161

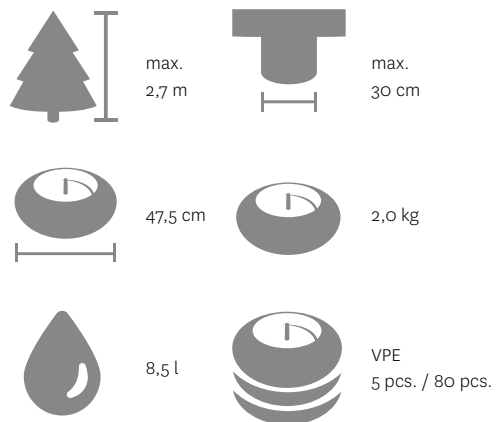
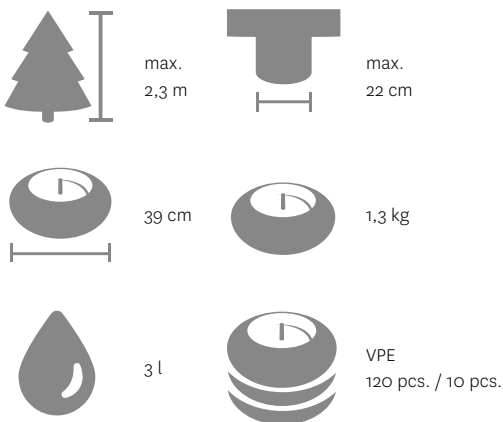

Classic

The Classic is our most popular waterstand.

Made of solid powder-coated steel with a diameter of 39 cm, it is available in ten different colours.

Suitable up to a total tree height of 2.5 m, and a trunk width of 15 cm.

In order to keep the tree fresh, up to 2.75 l of water can be added.

Classic, 39 cm, red metallic

Item-no.: 44100

Classic, 39 cm, white

Item-no.: 44103

Classic, 39 cm, green metallic

Item-no.: 44104

Classic, 39 cm, black matt

Item-no.: 44106

Classic, 39 cm, bronze matt

Item-no.: 44107

Classic, 39 cm, anthracite hammered

Item-no.: 44108

Classic, 39 cm, gold-anthracite hammered

Item-no.: 44109

Classic, 39 cm, wood-look

Item-no.: 44111

Classic, 39 cm, concrete-look

Item-no.: 44114

Classic, 39 cm, industrial design

Item-no.: 44115



Item-no.: 44100

Item-no.: 44103

Item-no.: 44104

Item-no.: 44106

Item-no.: 44107

Item-no.: 44108

Item-no.: 44109

Item-no.: 44111

Item-no.: 44114

Item-no.: 44115

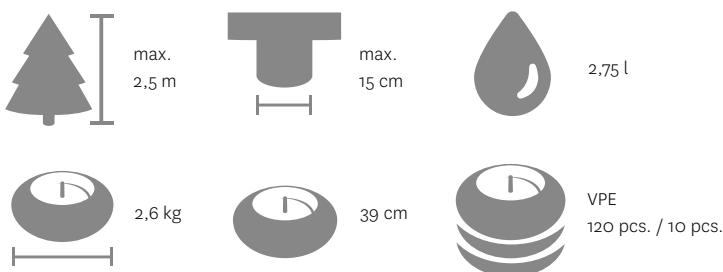

Maxi

Our high-quality Maxi stands are made of solid powder-coated steel and are available in four colours: green metallic, anthracite hammered effect, red metallic and wood-look. With a diameter of 49 cm, it is our largest waterstand for end customers.

Suitable for a maximum tree height of 2.8 m and a trunk width of 20 cm.

In order to keep the Christmas tree fresh, up to 5 l of water can be filled into the stand.

Maxi, 49 cm, green metallic

Item-no.: 44135

Maxi, 49 cm, anthracite hammered

Item-no.: 44136

Maxi, 49 cm, red metallic

Item-no.: 44137

Maxi, 49 cm, wood-look

Art.-Nr.: 44138



Item-no.: 44135



Item-no.: 44136



Item-no.: 44137



Item-no.: 44138



max.
2,8 m



max.
20 cm



49 cm



4,4 kg



5 l



VPE
80 pcs. / 5 pcs.



Maxi adapter

Made from solid steel, the Maxi combined with a Maxi water stand (not included) enables to set up trees up to 4 m.

In addition to the connection with the pin, the tree can be aligned with three adjusting screws.

Maxi adapter, Ø 131 cm, anthracite hammered effect

Item-no.: 44139

Profiline

Made from galvanized steel, the Profiline with a footprint of 80 cm in diameter is suitable for setting up large trees up to 4.5 m indoors. Eight locking screws are used to fix and align the trunk.

A water reservoir with up to 60 l keeps the tree fresh for a long time.

Profiline, 80 cm, galvanized

Item-no.: 40442



max.
4 m

max.
20 cm

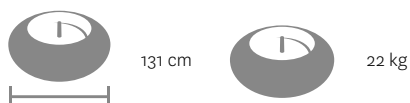

131 cm

22 kg



5 l

VPE
1 pcs



max.
4.5 m

max.
20 cm



80 cm

28 kg



60 l

VPE
1 pcs. / 10 pcs.

Kombistand

The Kombistands are ideal for putting up large trees indoors and outdoors. To set up the tree, it can be connected to the stand while lying down and then set up easily over the edge.

Scope of delivery includes:

- Kombistand
- metal ring to fix the trunk
- 4 tension belts for aligning the tip

A round 90 l mortar bucket can optionally be used to supply the tree with water (not included).

To further increase the stability, we recommend covering the stand with stone slabs. Fir branches can be used to clad the stand.

Maximum tree height with additional weight:
5 m (indoors) / 4 m (outdoors)

Kombistand, 100 x 100 cm, galvanized

Item-no.: 40453

Maximum tree height with additional weight:
6 m (indoors) / 5 m (outdoors)

Kombistand, 130 x 130 cm, galvanized

Item-no.: 40460



max.
4/5 m (outdoor)
5/6 m (indoor)

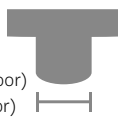

limitless

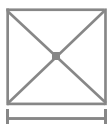

100 cm /
130 cm

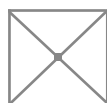

40453 | 21 kg
40460 | 22,5 kg



90 L
(optional)



VPE
1 pcs. / 25 pcs.



WOODEN STANDS

Wooden stands

Our Oak and Spruce stands with plastic or metal pin are ideal for setting up trees up to 2.5 m. The foldable / non-foldable stands are available with a diameter of 29, 39, 52, 58 or 78 cm.

NOTE: All wooden stands are recommended as end customer stands, not for presentation purposes.

Pre-assembled:

Cross stand spruce, 29 cm, non foldable, plastic pin

Item-no.: 44201

Cross stand spruce, 39 cm, non foldable, pin to hammer in

Item-no.: 44212

Cross stand spruce, 52 cm, non foldable, pin to hammer in

Item-no.: 44213

Assembly-kit:

Cross stand spruce, 29 cm, non foldable, plastic pin

Item-no.: 442012

Cross stand spruce, 58 cm, foldable, pin with thread

Item-no.: 44203f

Cross stand spruce, 78 cm, foldable, pin with thread

Item-no.: 44204f



item no.: 44201



item no.: 44212, 44213



item no.: 44203f, 44204f

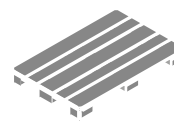

Item no.	Stand diameter (cm)	Tree height (m)	Quantity (pcs.)	Quantity (pallets)
44201	29 cm	1,25 m	100 pcs.	900 pcs.
442012	29 cm	1,25 m	-	1.200 pcs.
44212	39 cm	1,8 m	40 pcs.	360 pcs.
44213	52 cm	2,2 m	30 pcs.	270 pcs.
44203f	58 cm	2,2 m	20 pcs.	720 pcs.
44204f	78 cm	2,5 m	20 pcs.	560 pcs.

larger quantities on request

PROMOTION MATERIAL



Easyfix hoarding banner

PVC, eyed for outdoor installation.
Motive: Setting up the Christmas tree with the Easyfix system in three steps.

Easyfix PVC hoarding banner with robust metal eyelets,
340 x 175 cm

Item-no.: 44930



Easyfix advertising banner

PVC, eyed for outdoor installation.
Motive: Setting up the Christmas tree with the Easyfix system in three steps.

Easyfix PVC advertising banner with robust metal eyelets,
120 x 80 cm

Item-no.: 44931

Easyfix poster

Poster suitable for indoor use.
Motive: Setting up the Christmas tree with the Easyfix system in five steps.
Shipping only with pallet delivery!

Easyfix cardboard display (one-piece), 120 x 80 cm

Item-no.: 44936

DIN A2 poster for indoor use.
Motive: Setting up the Christmas tree with the Easyfix system in three steps.

Easyfix poster DIN A2, 42 x 59,4 cm

Item-no.: 44937



ACCESSORIES

Trolley

Stable transport trolley with punctureproof solid rubber tires. Ideal for transporting larger trees at the point of sale. Loadable with a maximum weight of 400 kg.

For better maneuvering, a steel tube (item no. 44471) can be inserted at the upper ends to push the trolley (not included in the scope of delivery).

Transport trolley, 650 mm width breit (for trees up to 4 m)

Item-no.: 44802-s

Transport trolley, 750 mm width (for trees up to 6 m)

Item-no.: 44802



Netting

Netting 34 cm ø, 3000 running meters (10 nets)

Item-no.: 70534

Netting 45 cm ø, 3000 running meters (10 nets)

Item-no.: 70545NT

Netting 55 cm ø, 3000 running meters (10 nets)

Item-no.: 70555

Drillbit

Drillbit with 12 mm diameter for commercial hand drills*.

Drillbit HSS TIN steel, 12mm

Art.-Nr.: 44723

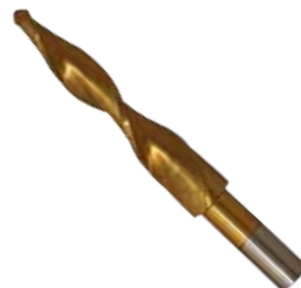

* NOTE: Without an existing adjustment aid, it is not possible to guarantee that the hole will be drilled vertical



Outdoor jacket

Waterproof jacket in dark green with red fleece lining. Perfect fit also during work due to the elastic on the sleeves and waistband. A full-length belly pocket with Velcro fastener offers sufficient storage space.

Jacket Christmas tree sale (size M)

Item-no.: 75200

Jacket Christmas tree sale (size XL)

Item-no.: 75210

Jacket Christmas tree sale (size XXL)

Item-no.: 75220



Outdoor trousers

Waterproof cover trousers in dark green. High wearing comfort even when working due to the elastic band on the waist and legs. One inside pocket and one full zip pocket.

Rain trousers (size M)

Item-no.: 75100

Rain trousers (size XL)

Item-no.: 75120

Various

Netcutter (25 pcs / VPE)

Item-no.: 72100

Utility knife (25 pcs / VPE)

Item-no.: 72110

Stapler „Adoro“ (10 pcs. / VPE)

Item-no.: 74200

Staples for stapler „Adoro“, 20.000 pcs.

Item-no.: 74201

Gloves size 10 (12 pcs. / VPE)

Item-no.: 75412



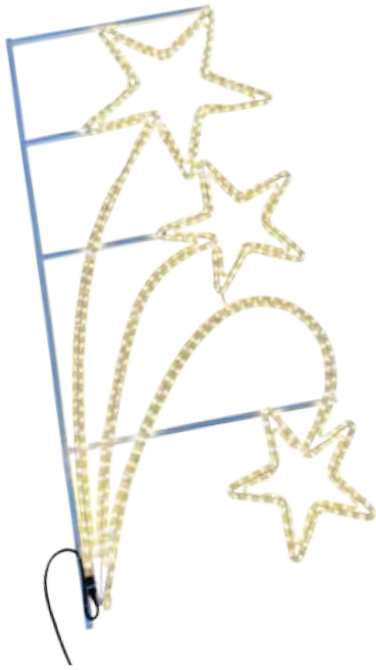

Light tube stars

LED light tube stars in a steel frame. Robust for outdoor use.

Model can be combined with outdoor light chain E27 (item-no. 55135).

Light tube stars in a steel frame 144 x 68 cm, 1.5 m cable, warmwhite (3 pcs / VPE)

Item-no.: 55123

LED light chains

Lightchain outdoor E27, 12.6 m, 15 sockets including 17x3 W LED bulbs, warm white, extendable, IP65 (4 pcs. / VPE)

Item-no.: 55135

Minibulbs light chain indoor, 100 LED lights warm white, extendable, IP65 (20 pcs. / VPE)
(11 m + 1 m electrical supply)

Item-no.: 55131

Minibulbs light chain outdoor, 100 LED lights warm white, extendable, IP65 (20 pcs. / VPE)
(11 m + 1 m electrical supply)

Item-no.: 55133



Fertilizer

Chrysal Treefood, 500 pcs.

Item-no.: 44500

RETAILERS IN EUROPE

Toppii Aps (DK)

info@toppii.dk
Tel. +45 244 157 32

Fjellgran DA (NOR-SWE-FIN)

post@fjellgran.no
Tel. +47 90 638 638

Easyfix Polska sp. z o.o. (PL)

biuro@easyfix.com.pl
Tel. +48 601 407 886
Fax +48 32 700 7719

The Christmas Cabin ltd. (GB)

sales@thechristmascabin.com
Tel. +44 1780 411 144
Fax +44 1780 411 092

Tannen-Paradies GmbH

(DE-AT- OTHERS)

shop.tannen-paradies.de

easyfix@tannenparadies.de
Tel. +49 (0) 30 707 83675
Fax +49 (0) 30 706 91 38

Veldhuizen & Bisselink (NL)

info@vbkerstbomen.nl
Tel. +31 318 301 056

Agro Service GmbH (CH)

info@agroservice.ch
Tel. +41 44 491 60 42
Fax +41 44 400 52 25

Greencap SA (FR)

info@greencap.eu
Tel. +33 6 09 38 33 62
Tel. +32 61 23 08 30

easyfix®

