

Professional Catalogue

SMART HVAC CONTROL
2023/2024

 Updated
02/24

Airzone Global

Corporación Empresarial Altra
Growth, innovation and assistance
throughout the country.

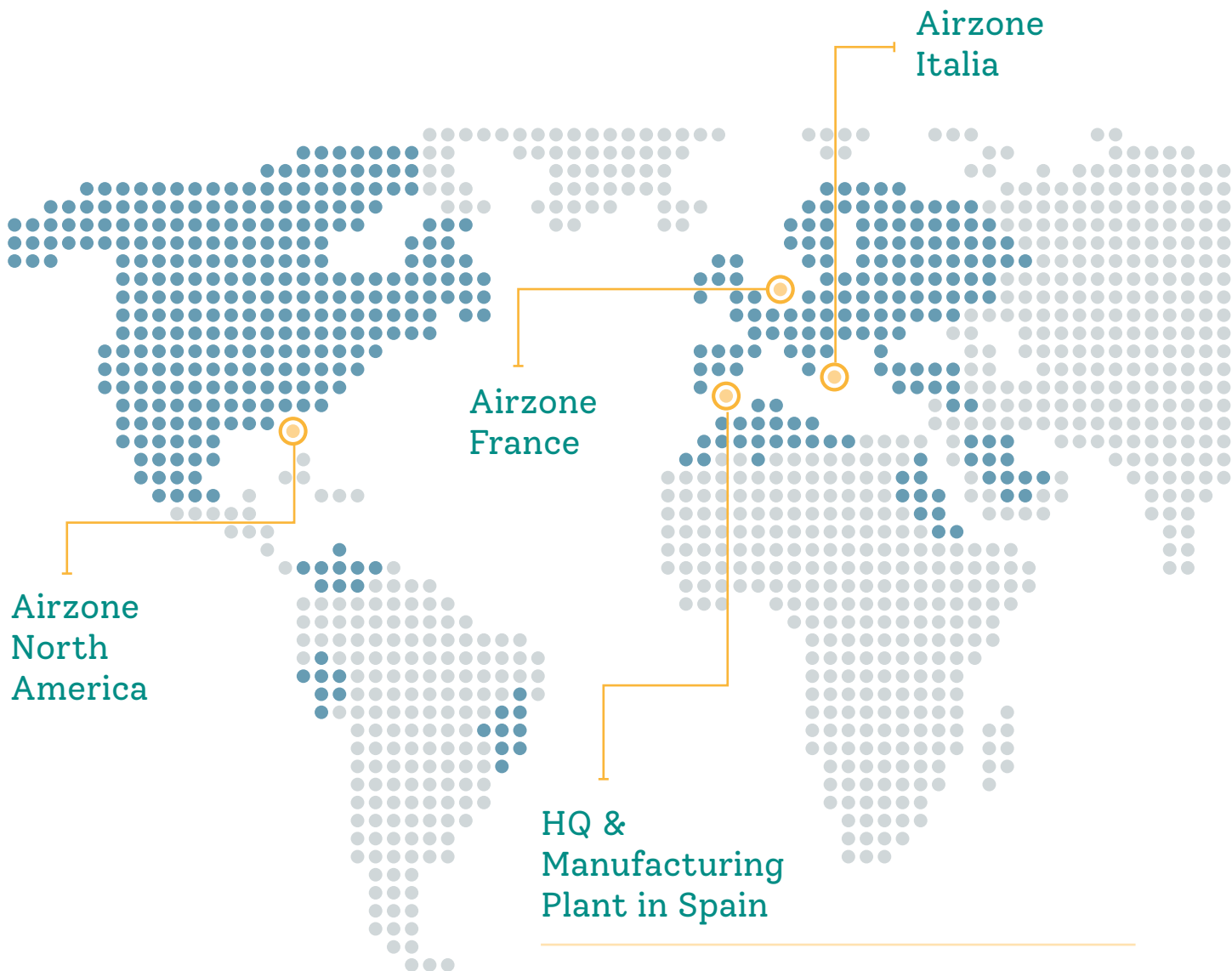

Our manufacturing centre located in Malaga (Spain), has a production area of more than 5,000 m². Of all our manufacturing, 50% is installed internationally.



Browse the catalogue
with just one click!



About
Us
02

Control
360
06

Energy
efficiency
22

Pro
Services
26

Control
solutions
34

Pricelist
Airzone
56

Airzone, far more than a product

At Airzone, we offer **integrated and efficient heating and cooling control solutions** that put user's well-being first.

We are constantly carrying out **research and development projects to offer the best solution** on the market and position ourselves as a world leader in air quality and control systems.



An international company

We have a global presence and have our own offices in Spain, France, Italy and the United States.



We focus on digitalisation

Our platforms and tools are available 24/7.



Technological innovation

We develop solutions based on the latest technology on the market and offer state-of-the-art connectivity.



Large range of products

We have a solution for all technologies and all types of HVAC applications.



More than

70,000

Airzone installations
connected around the world

SINCE 2016

More than

800,000 t

of CO₂ saved with
our systems



More than

450,000

Airzone systems
installed

SINCE 1997

More than

90% increase
in comfort*

* Data taken from the report on the Airzone zoned model,
produced by UMA: airzonecontrol.com/support/downloads



We are working for the change

Integration with HVAC units

Protocols certified by the manufacturer. Improved energy performance and reduced installed power of inverter units.



Control solutions

Solutions compatible with Inverter, VRF, chilled water and boiler technologies. All control is done from a single interface, for both residential and commercial buildings.

Creation of zone systems

The first step towards optimal comfort: control of ducted units in each room.

1997

Internationalisation of the company

More than 65% of our production operates internationally.



2008

The arrival of digitalisation

State-of-the-art technology with the Airzone Cloud application, tools and on-line technical support.

the world needs

A guarantee of quality

We adapt to current standards to obtain product certifications such as eu.bac and optimise the sustainability of projects by improving BREEAM, LEED or WELL qualifications.



Improvement of air quality

We focus on well-being. Healthy environments with comfort adapted to the needs of the user.

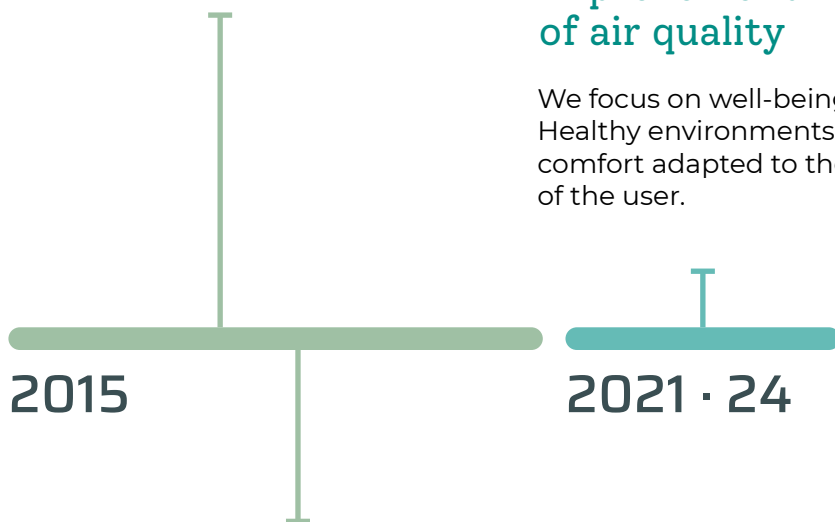

Integration with BMS and home automation

Airzone combines HVAC technology with the latest IoT trends.



Set the living room temperature to 21°C

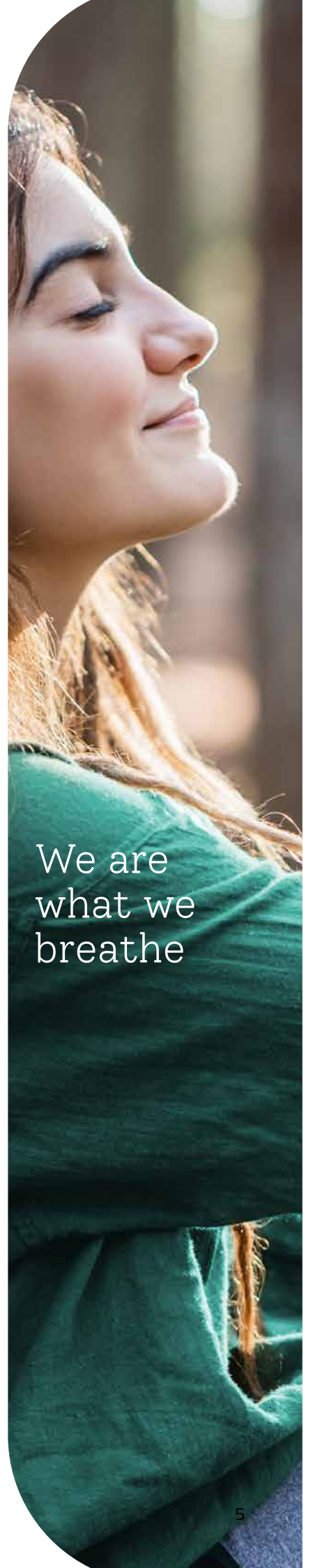

We are what we breathe

Switch over to control 360°



Air quality

The well-being of users is at the core of our vision of control. Monitoring air quality is intended to **ensure healthier air.**



HVAC Control

Enjoy easier and faster management and configuration. We're **compatible with all the leading brands in the industry.**

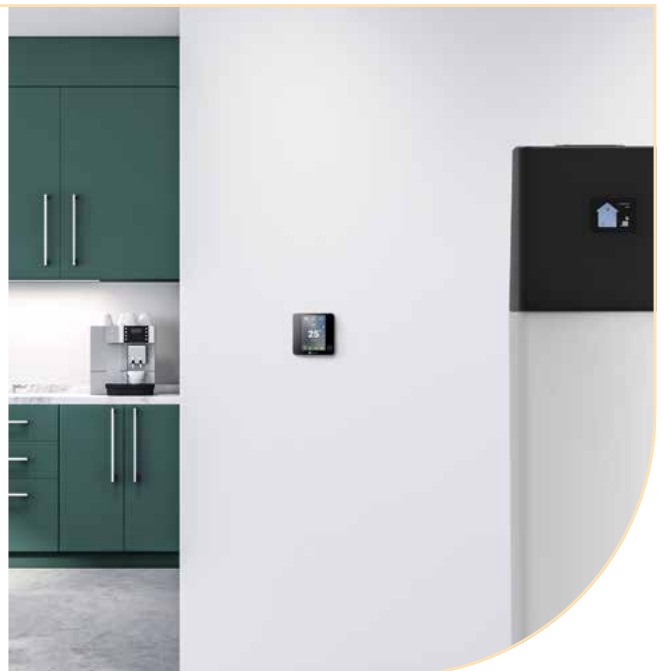



Connected solutions

We offer smart and versatile control, to manage heating and cooling **remotely and at any time.**



Integrated solutions

Our product line has been created with a view to diversity and our solutions can be integrated with **BMS and home automation systems.**

Air quality and HVAC

What is air quality?

Indoor air quality (IAQ) refers to the **purity levels of breathable air** in a building.

Temperature, humidity, CO₂ and **airborne particles** such as dust, mites and VOCs, as well as mixtures such as air fresheners or smoke, all **affect air quality**.

Poor air quality can lead to allergies, fatigue, dizziness, headaches and eye, nose and throat irritation.

More than **90%** of our time is spent indoors



Why treat indoor air?

- We spend **more than 90% of our time indoors**.
- The level of air pollution of indoor air is **2 to 5 times higher than that of outdoor air**.
- We breathe **21,600 times** a day.

Air quality and HVAC

The main challenge of ionization-based air purification systems is to **efficiently direct the air from the spaces to be treated towards the ionizing devices** and, subsequently, to ensure a homogeneous distribution of the already purified air in the application.





Air quality on Airzone Cloud

Thanks to the Airzone Cloud app, **you can control the indoor air quality** of both your residential and commercial spaces **anytime, anywhere.**



3 levels of air quality.



Visualization of the air quality graph for each of the measurements (CO₂, PM_{2.5} and PM₁₀, VOC, temperature and humidity).

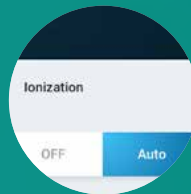

Operation modes: activated, deactivated and automatic.

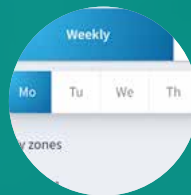

Scheduling of ventilation and air purification operating times.

Airzone Technology

AirQ Box

AirQ Box is the air purification solution developed by Airzone for rigid ducted HVAC applications, using the same mechanism as nature: ionization. It is based on the generation of negative ions that attach to the harmful particles present in the air to neutralize them.

The challenge of ionization-based air purification systems is **to direct the air from the occupied rooms to the ionizers and then distribute the purified air**. AirQ Box solves this problem by using the existing flow in the HVAC ducts of residential and tertiary installations.



AirQ Sensor

CO₂ concentration is one of the air quality variables that can deteriorate the fastest. A 30 m² room occupied by 10 people can reach 800 ppm, the maximum recommended level of CO₂, in 15 minutes, and thus requires ventilation.

AirQ Sensor permanently monitors CO₂ levels to automatically activate the forced ventilation system of the application.

This solution also records the concentration of particles and volatiles and, together with AirQ Box, provides a comprehensive response to air quality problems in residential and commercial installations.

Easyzone IAQ

Easyzone IAQ is a solution that provides **air purification, zoned HVAC and connectivity** to installations with circular ducts in residential and tertiary settings.

Ionization-based purification **removes harmful particles from indoor spaces**. Through zoning, heating or air conditioning units work only in areas where there is demand, and connectivity allows users to control and configure units from their mobile device and voice assistants. This translates into **greater well-being, energy savings and comfort in all rooms**.



enjoyyourair

What is Quality Air Zone?

The **Quality Air Zone sign** is used to indicate an indoor space that features an AirQ air purification solution, developed and manufactured by Airzone.

The air in Quality Air Zone spaces is treated to eliminate the majority of the suspended particles that can cause discomfort, allergies or diseases.



You can find the adhesive **Quality Air Zone*** sign on the doors of shops, restaurants, clinics and offices. It can also be found on HVAC units of residential installations that incorporate this technology.

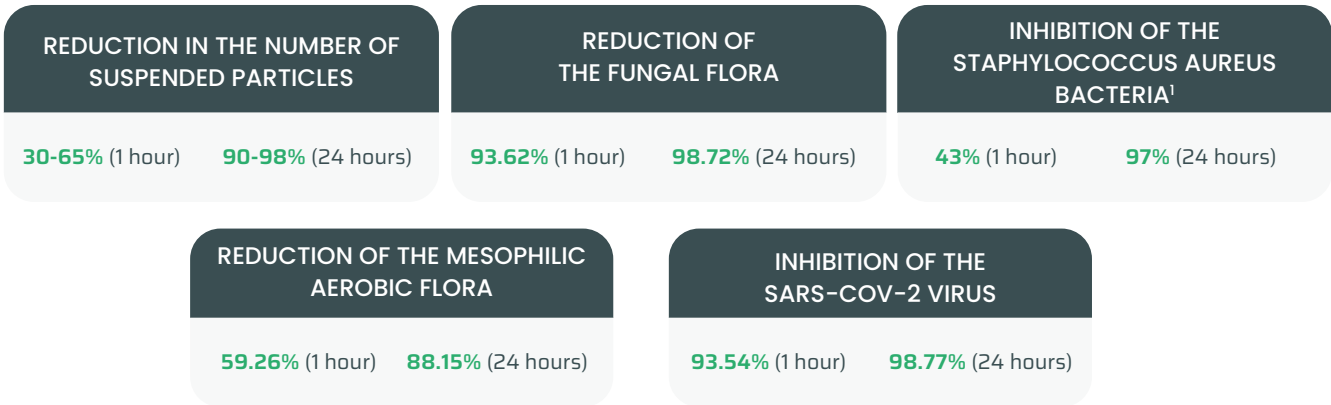

Data extracted from studies conducted by the IPROMA, University of Granada and Texcell laboratories.

¹ NCTC 8532 strain.

* This sign is supplied with AirQ and Easyzone IAQ products.

Full control heating and cooling systems



Integration of the main technologies

Our solutions allow centralised control of the **main heating and cooling technologies on the market**, for both multi-zoned and single zone systems.

- Air-to-Air heat pump
- Air-to-Water heat pump
- VRF
- Multisplit and monosplit Inverter
- Domestic hot water
- Boiler

Protocols certified by the manufacturers

We work with industry leaders to ensure **two-way communication**. By using the same communication protocols, we keep the original functions of the unit intact. **We develop communication gateways as well as control algorithms** which, together, make it possible to obtain a high level of comfort and a decrease in consumption.

Controlled mechanical ventilation

Airzone control by means of Easyzone motorised plenums makes it possible to **use the same ductwork for thermal treatment and air renewal**, while keeping them independent and autonomous.

Eco-Adapt: temperature optimisation and limitation

The Eco-Adapt algorithm dynamically adjusts **the set-point temperature** of the unit according to the return temperature. Eco-Adapt ensures optimum comfort for the user, as well as an improvement in the performance of the unit, since it operates as long as possible at partial load. By applying zone control to a space, **a 20 to 30% increase in performance of the unit is obtained, compared to its rated performance.**

Q-Adapt: control of the speed

Function that enables selecting **the fan speed of the zoned AC units according to the zones on demand.** The solution is thus adapted to the particularities of the application and the needs of each zone in terms of flow. Depending on the system, it is possible to regulate the flow rates:

- By assigning weights to each zone.
- Thanks to 5 preset modes.

Combined control of the air and radiant elements

The control of air stages and radiant elements in cooling and heating mode is combined on a single thermostat. Thanks to the efficiency algorithms, optimum levels of comfort and maximum performance of the application are obtained.

First, we apply state-of-the-art technology to control the thermal inertia of the floor and offer a more pleasant feeling of warmth.

In addition, the air stages provide an immediate sensation of warmth, which allows you to obtain the desired comfort and stabilise unforeseen variations in temperature.

This combination of systems avoids overheating the zones and reduces energy consumption.

MANUFACTURERS







Airzone Blueface

Enjoy control using a touch
screen

  | Wired | Configurable as primary

 On/Off

 Temperature control

 Indoor air quality¹

 Humidity reading

 Selection of the mode²

 Basic configuration

 Navigation by zone

 Eco-Adapt function²

¹ Available only with products that include AirQ technology.

² Available if the thermostat is configured as Master.

  | Wireless

| Configurable as primary

 On/Off

 Temperature control

 Indoor air quality¹

 Humidity reading

 Selection of the mode²

 Basic configuration

 Navigation by zone



Airzone Think

Control with
capacitive keys

¹ Available only with products that include AirQ technology.

² Available if the thermostat is configured as Master.







Airzone Lite

Simplify control and increase
or lower the temperature by 3
degrees

  | Wired and wireless

| Data configurable via the
Blueface thermostat and/
or the Airzone Cloud app.

-  On/Off
-  Temperature control
-  Humidity reading
-  LED lights



Play Store



App Store



Demo

UNIFIED CONTROL OF AIRZONE AND AIDOO SYSTEMS

MULTI-USER: ADD ADVANCED OR BASIC USERS

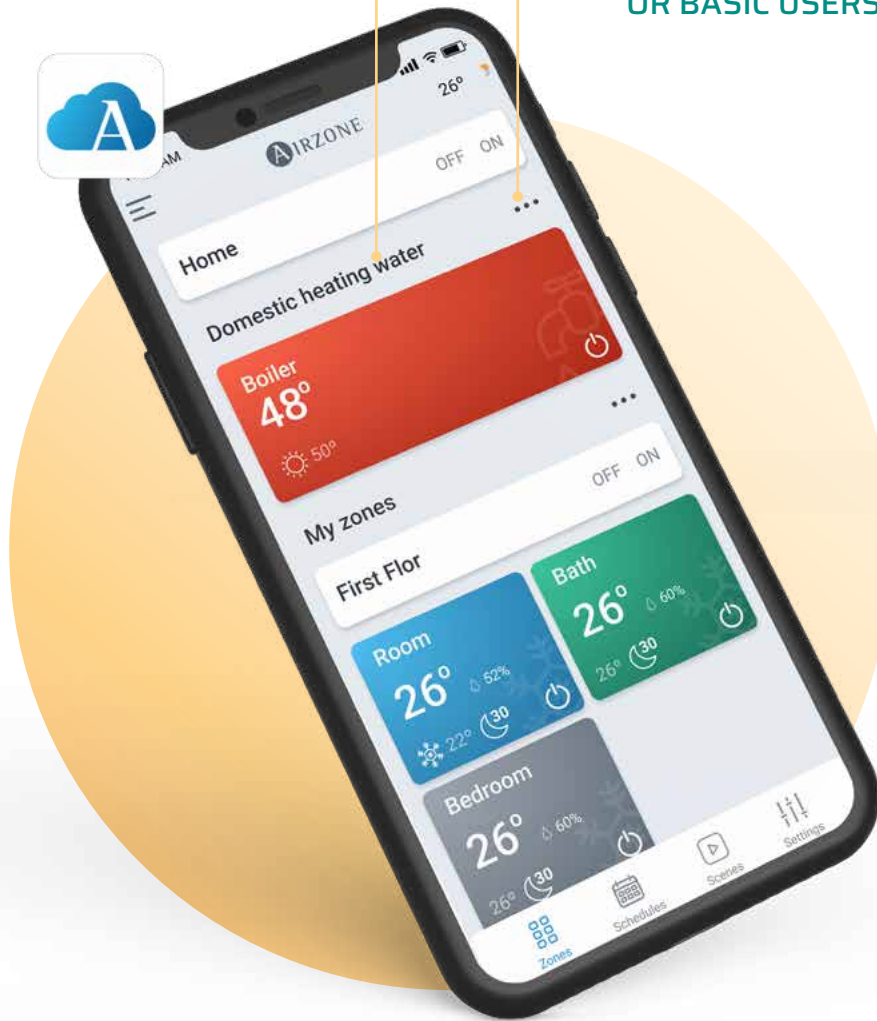

Airzone Cloud

Control your entire system using the new Airzone Cloud application

 On/Off

 Temperature control

 Indoor air quality*

 Humidity reading

 Selection of the mode

 Advanced configuration

 Navigation by zone

 Programming

 Eco-Adapt function

* Available only with the Easyzone system.

New features Airzone Cloud

The most complete control, wherever you are

The Airzone Cloud app has been revamped to offer you **the best control experience** through a simple and intuitive interface* and **the latest Cloud technology**.



Customizable

Organize the elements of the app to adjust the interface to your needs.



Graphs

View the evolution of the temperature and indoor air quality of each zone.



Consumption

View the consumption of the HVAC application.**



Scenes

Use HVAC scenes to adapt the operation of the HVAC application to your lifestyle and needs.

* An Airzone Cloud Webserver or Aidoo must be installed to use the app.

** Only available for installations with an Airzone consumption meter.

Voice control



Support

Find all the information about the installation and management of an Airzone system in the same app.

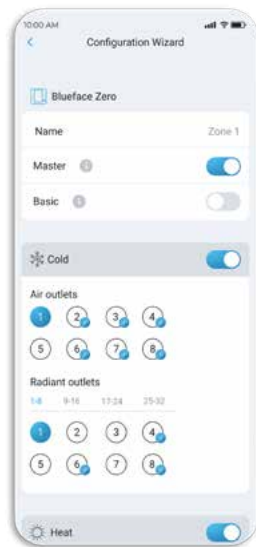

Settings

Set up an Airzone system easily thanks to the new configuration wizard.

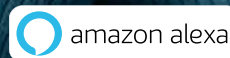

Only available for 2016 range systems.



Integration of heat pumps

Take advantage of the benefits we offer in terms of **integrating building management systems (BMS*) and home automation**. Let Airzone take care of the control of the heating and cooling systems



Quick and easy integration

Easily integrate any HVAC technology in a very short time.



Integration gateways

We have specific gateways for KNX, BACnet and Lutron systems.



Simple configuration and programming

Your systems are integrated thanks to our drivers developed with the protocols of main home automation brands.



Cloud API and REST API

Make the most of integration with any platform.

INTEGRATED HVAC CONTROL FROM ALL INTERFACES

- Control of independent zones:
 - Set-point temperatures.
 - Zone status.
 - Reading of room temperature and humidity on the zone.
 - Management of the air stage and stage by radiant elements.
- Operating mode of the system.
- Adjustment of the fan speed of the indoor unit.
- Control of domestic hot water (DHW).
- Easy detection of HVAC unit and home automation errors with our stand-alone system.

* BMS: building management systems.



BMS AND HOME AUTOMATION

ALARM.COM® alfredsmart bticino CHERUBINI

Control4 CRESTRON DELTA DORE eedomus ELAN®

ezlo innovation FERMAX fhe FIBARO Homey iEEDOM legrand®

LOXONE LUTRON. Nice RTI SAVANT Schneider Electric

U&C vera WAGO zipato®

STANDARD PROTOCOLS

BACnet® Modbus KNX zigbee ZWAVE

IOT

amazon alexa Works with Apple HomeKit works with the Google Assistant Works with SmartThings

Home Assistant SMART CONNECTIVE & energeasyconnect ecobee

Honeywell nest Pelican telkonet VENSTAR®

Towards sustainable construction



Certifications at the service of your projects





Airzone provides a concrete response to environmental issues by focusing on optimising thermal comfort for the user and improving the building's energy performance.

Passivhaus



Construction standard that **combines high interior comfort with very low energy consumption** at an affordable price, thanks to the utmost care for the building envelope and the efficiency of the air conditioning systems.

Airzone systems provide enhancements that help meet the necessary requirements of the Passivhaus Buildings standard.

-  Reduction of energy consumption
-  Reduction of installed power
-  Regulation by zones
-  Limitation of hours of overheating



MORE INFORMATION:
airzonecontrol.com/projects

eu.bac



The eu.bac European certification guarantees the energy efficiency of building control systems, in compliance with the EN15232 standard.

Both for the air vector and for underfloor heating, the value of the regulation of our systems is eu.bac certified with a CA (Control Accuracy) ranging from 0.2 K to 0.5 K. This allows our systems to reduce the application's energy consumption and greenhouse gas emissions, thereby improving the building's energy label.

LEED



System for environmental performance in the construction or renovation of buildings. It seeks to achieve a **reasonable and effective use of energy in terms of materials and water**.

The system evaluates buildings according to 8 criteria and Airzone can earn extra points in:

- Energy and Atmosphere
- Indoor Environmental Quality

WELL



Certification guaranteeing that **the space has obtained a certification favourable to the health and comfort of its occupants**. It encompasses 7 fields of application. Airzone has an impact on the following:

- Air
- Thermal Comfort

BREEAM



System intended to evaluate and certify **the environmental performance of a building**. This method promotes the most sustainable constructions. The system evaluates 10 categories. Airzone optimises the operation of heating and cooling systems and helps improve ratings in the following categories:

- Management
- Energy
- Health and comfort

DGNB

Airzone's air quality and control systems can contribute to improving the percentages obtained in the categories related to:

- User Control
- Energy Efficiency
- Thermal comfort
- Indoor Air Quality
- Use and Integration of Building Technology

The information provided in the BREEAM section refers to the categories contained in the international manual for all of Europe with the exception of Germany, Austria, Spain, Norway, the Netherlands, Sweden and Switzerland. The individual outline of the BREEAM manual for each of these countries can be found at the following link: bregroup.com/products/breem/breem-engage/breem-partnerships/

Grants and aids

We help you **take care of our planet**



The major world powers have established **sustainability goals in their strategic plans**. One specific example is the initiative of the European Union, which aims to improve energy efficiency by at least 32.5%. We help you to obtain grants, because **our solutions improve the energy performance, thermal comfort and environmental performance** of buildings.

In Europe, many grants have been put in place to encourage renovation work and the construction of sustainable buildings, both for professionals and for individuals. Through NextGenerationEU and Renovation Wave programs.

How do I obtain grants and aids?



CONTACT OUR TEAM:
projects@airzonecontrol.com

Validated levels of comfort and efficiency

We are aware of the importance of the energy efficiency of our solutions and optimisation of thermal comfort. To this end, we carry out **comprehensive tests in our specialised laboratories**.

We also rely on **independent studies, which guarantee the impartiality of the results** obtained by our solutions.



COMPREHENSIVE STUDIES:
airzonecontrol.com/support

STUDIES OF OUR SOLUTIONS

Up to

37%

reduction in
installed power

Reduction of installed power in air-to-water heat pump systems

Explanation of how Airzone allows the use of a less powerful heating and cooling unit, while combating the simultaneous thermal load.

- In cooling, the reduction of the simultaneous load varies from **19 to 47.6%**.
- In colder cities it is reduced to less than **7.7%**, and in more temperate climates it is around **13%**.

33%

Reduction

in greenhouse gas
emissions

Airzone solutions in residential and commercial projects

A ducted indoor unit, controlled by the eu.bac certified Airzone system and under Technical Assessment improves various aspects in heating and cooling projects:

Residential buildings:

- Improvement of the **energy label** of the building.
- Decrease in **overall primary energy coefficient by 50%**.

Commercial buildings:

- **75% fewer indoor units.**
- **44% reduction** in the amount of refrigerant gas present in compliance with standard **EN 378**.

Comparison between the Airzone model and a system without zone control

Description of the advantages of a zoned system in terms of thermal comfort, electrical consumption and installed power.

- A zoned system leads to a **reduction in thermal load**, which makes it possible to opt for a unit with a lower thermal power.
- The percentage of **hours of thermal comfort in the zones is much higher** in a zoned system.
- The Eco-Adapt algorithm provides energy savings of up to **37% in heating mode and 59% in cooling mode**.

Up to

37%

savings in heating
mode

Continuing professional development with Airzone Academy

Train with industry leaders on our on-line platform for professionals and keep up to date with the latest advancements.



Choose the topic

Consult the list of courses and register for free for the one that interests you the most. You can take as many courses as you want.

Flexible schedules

We have planned different training modalities to adapt to your schedules: webinars, on-line or face-to-face courses.



For all profiles

All courses are carried out in a structured way with specific programmes, in order to adapt to all the technical profiles of the participants.



Become an expert

 Get your Airzone Pro badge

Complete a **free training programme** made up of several courses and become an Airzone expert.

The first step towards a closer collaboration with Airzone!



With the **Airzone Pro Installer** programme, you will discover how our control systems work.



With the **Airzone Pro Specifier** programme, you will discover the different solutions, by type of technology and application.

Still don't have an Airzone Academy account?



Go to airzonecontrol.com, click LOG IN, then click **Sign up!**



Activate the account from your email.



Visit the **Academy** and start training.

We are part of your projects

Drawing on more than 25 years of specialisation in the sector and collaboration with heating and cooling professionals, we are at your disposal with **a team of engineers who will help you develop your projects.**



Comprehensive advice

We provide you with all the resources you will need throughout your project.

CONTACT OUR TEAM:

projects@airzonecontrol.com

DOWNLOADS:

airzonecontrol.com/projects/resources



Visit airzonecontrol.com and discover **our services and tools** for professionals.

DUCTZONE

Download our **free software for the design and calculation of heating and cooling installations**, compatible with all types of constructions.

Airzone software

Certificates

Our solutions are approved by the current **main certifications** in terms of heating and cooling and energy efficiency.

Studies

To demonstrate the effectiveness of our solutions, we have conducted various case studies **in collaboration with several universities**, which serve as a reference for each type of project.

Tools and resources

CAD

CAD blocks of Airzone products and connection diagrams, depending on the solution.

RE2020 DATA RECORDS

These records represent the **regulations concerning** our heating and cooling solutions.

BIM

Catalogue of product families in Revit format, with BIM&CO and BIMobject.

Technical Support

Our **team of Airzone product experts** are dedicated solely to providing you with comprehensive technical help and support, in the fastest way possible.

Need technical support?

+44 330 822 0991 / +34 900 400 445

techsupport@airzonecontrol.com
airzonecontrol.com/support

Monday to Thursday:

From 8:00 to 14:00 and 15:00 to 17:30 (CET)

Friday: From 8:00 to 17:00 (CET)



We support you every step of the way

We adapt to your needs by offering you **customised solutions**:

- Commissioning assistance.
- Customised assistance for your project.
- Management of warranties and returns.



Assistance with remote access

By adding an Airzone Cloud Webserver, our experts can **monitor your systems' settings in real time** and modify them, if necessary.



Logistics Services

Airzone's logistics area is dedicated to offering an optimal transport service, seeking a balance between time, service and quality, for national and international shipments.

Incoterms

EXW – Exworks

The customer must arrange transport to pick up the goods at our premises. We can store the order for 20 calendar days at our factory.

DAP – Delivery at place

Airzone is responsible for shipping and tracking the goods until they reach their destination. The customer must arrange the import clearance in the destination country and is also responsible for paying duties and taxes.

Types of services

Land transport by road. Economy service

Groupage service by road. The material may arrive on different days and/or times if the shipment contains more than three pallets.

Air transport. Express service

Used for the **urgent shipment of non-palletized orders.**



DDP – Delivery duty paid

Airzone manages and is responsible for the transit of the goods to their destination, as well as the clearance procedures and derived expenses.

Economy and express air cargo transport

This is used for the **urgent shipment of palletized orders.** Shipment is made with the Economy service or, for an additional amount, with the Express service.

Direct truck transport by road

For orders of more than 9 pallets, the shipment is made by direct truck, in a single delivery, with a security seal and prior appointment for unloading.

Truck transport on a per meter basis

Orders of more than 6 and less than 9 pallets are shipped by truck on a per meter basis and in a single delivery, with notice of the approximate day of arrival, without an appointment for delivery.

International transits by sea transport

Service for the international transit **of orders with a high number of pallets**. Boarding will be arranged with the shipping company, taking into account that the transit time is longer.



Commercial documents

Goods must always be accompanied by the relevant commercial documents for their correct transit and customs management. These documents include the delivery note or invoice depending on the destination country and the packing list with indications of the packaging of the goods with their corresponding HS Code.

Order traceability

EXW orders will receive an email with instructions for picking up the goods.

When shipping is arranged by Airzone, customers will receive a tracking link from the transport company.

Damage and returns

Airzone offers its assistance to claim for possible damage during transport. For this purpose, it is necessary to check the goods upon delivery. If it is not possible to check the goods at the time of delivery, a note should be left with the carrier indicating "Goods to be checked".

In case of damage to the packaging or material, the carrier and Airzone must be notified immediately. Claims must be made to the transport agency within 10 working days.

Sustainability

Airzone is striving to eliminate plastic in the packaging of our goods and implement the use of cardboard pallets. The purpose of these measures is to reduce the environmental impact of our deliveries.

Find Us Online

In our updated website, you will find a **platform for professionals**, helping them with all their major needs throughout the project life cycle.

CONTROL SOLUTIONS

All useful information about our products.

PROJECTS

Wiring diagrams, Ductzone software, certificates and design advice.

SUPPORT

Comprehensive support with technical information on products, brochure, catalogue and data sheet downloads, and FAQs section.

ACADEMY

Platform offering all the necessary training for professionals.

BUYING AIRZONE

Creation of quotes and orders.

Your Profile

By registering in the Web platform, from your personal profile you can also manage:

- Delivery addresses.
- Quotations and related orders.
- Returns and warranties.
- Requests for assistance via Tickets.
- Authorization for different functions of your Team.



MORE INFORMATION:
airzonecontrol.com

Follow the status of your order with one click!

Just provide your internal order reference or the number provided by Airzone in the **Tracking** section.



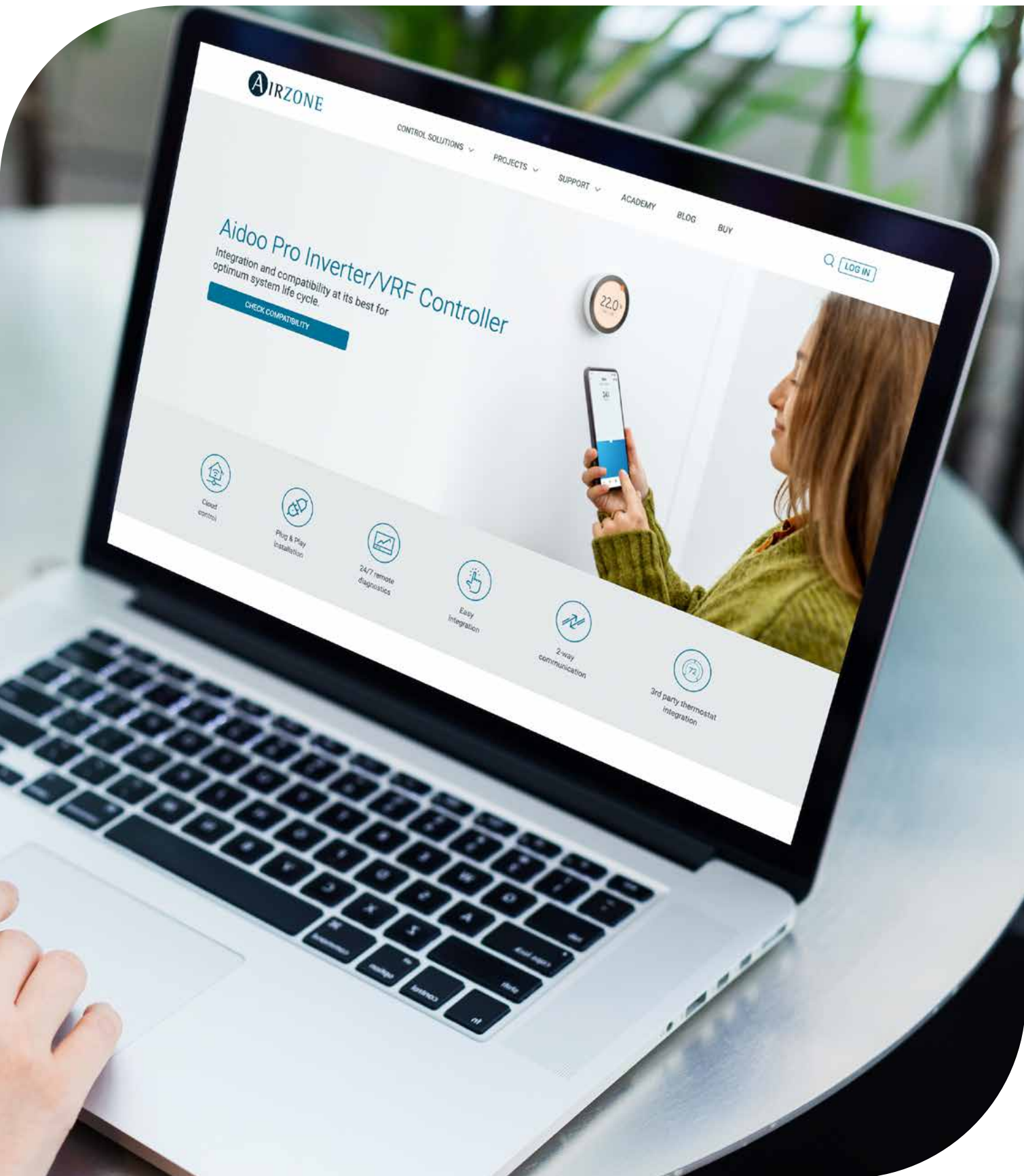

Indoor air quality

Indoor air quality solutions.

AirQ solutions improve indoor air quality through ionization-based air purification and mechanical ventilation control regulated by air quality sensors. With AirQ, it is possible to **combine HVAC with purification through ionizers** distributed in the ductwork, and with automatically controlled ventilation.



Aidoo Pro. Control of the indoor unit and ionizers

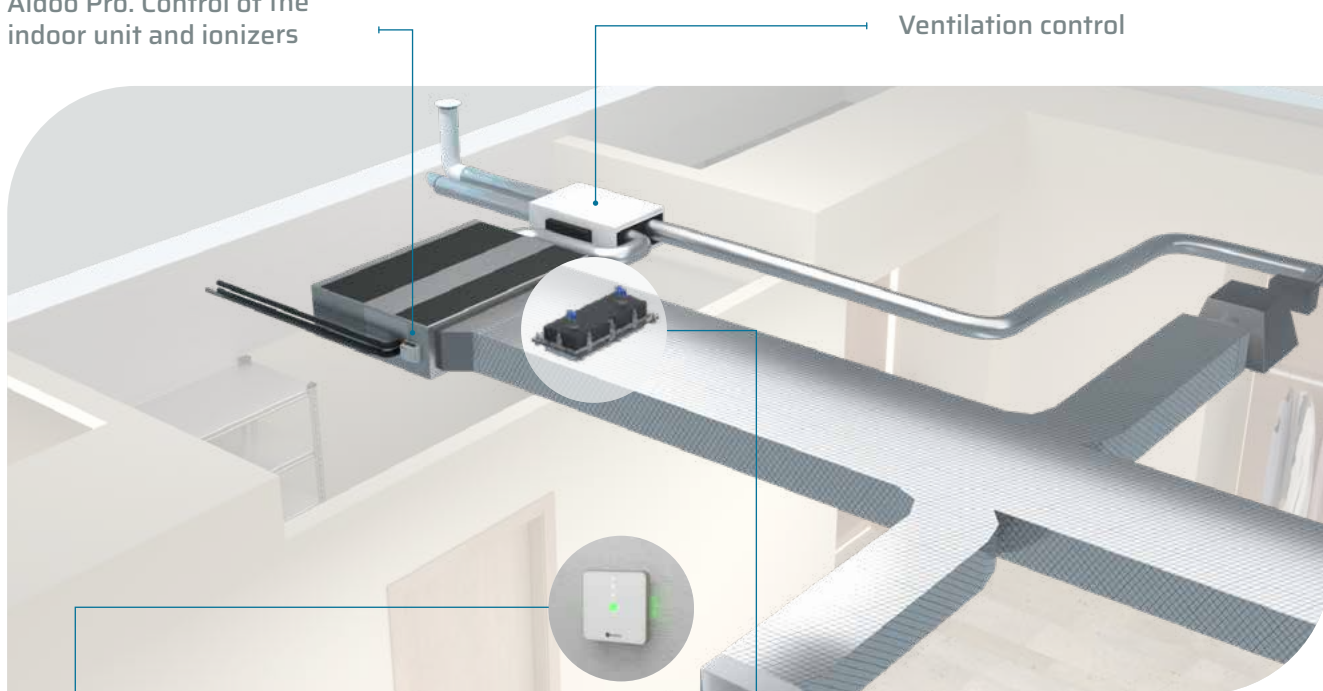

AirQ Sensor. Room air quality and ventilation performance

AirQ Box.
Up to 6 ionizers

- Measurement of **CO₂ levels, PM_{2.5} and PM₁₀ particles, volatile organic compounds,** temperature and humidity.
- **Air quality status** indicator.
- **Reduction in pollutants** through ionization (particles) and ventilation unit control (CO₂, VOC).

- **Operation modes:** automatic, activated and deactivated.
- **Graph-based reports** on the improvement and evolution of air quality levels in the Airzone Cloud app.

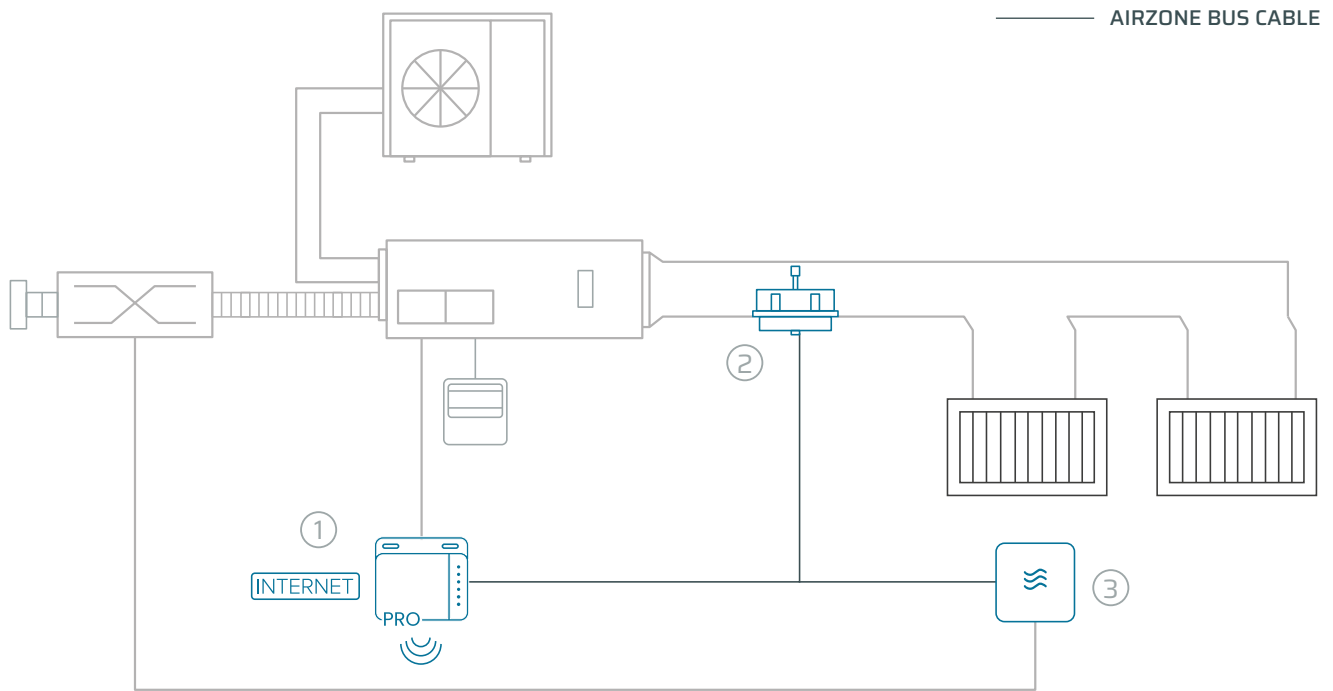

Reference	Description	Units
1 AZAI6WSP [XXX]	Aidoo Pro [Brand] by Airzone	1
2 AZX6AIQBOXM	AirQ Box in-duct IAQ monitoring and control device	1
3 AZX6AIQSNSB	AirQ indoor air quality (IAQ) sensor	1

- 
IAQ measurement and control
- 
Time schedules
- 
Remote management
- 
Weather forecast
- 
Residential and tertiary

Health, well-being and comfort

With the AirQ Sensor, **we control ventilation, and thanks to the AirQ Box, we ensure indoor air quality**, reducing allergens, pollutants and odors, while maintaining low CO₂ levels. This combination not only improves health, but also enhances cognitive abilities, prevents diseases and promotes better quality sleep.

Efficiency and savings

The smart management of mechanical ventilation performed by AirQ Sensor on demand **reduces the ventilation load by up to 21%**, extending the service life of filters and fans.*

AirQ Box reduces the number of suspended particles, so the AirQ Sensor will reduce your need to take action on the recovery.

A single app

Our unique solution **combines HVAC and air quality in a single app**, making it possible to control purification and ventilation in any of the three operation modes, program time schedules or combine actions in scenes. It also offers graphs showing air quality evolution.

*Lu, X., Yang, T., O'Neill, Z., and Zhou, X. Energy and ventilation performance analysis for CO₂-base demand-controlled ventilation in multiple zone VAV systems with multiple recirculation paths. 2020 Building Performance Analysis Conference and SimBuild co-organized by ASHRAE and IBPSA-USA

Aidoo devices

The connectivity and integration you are looking for

Welcome smart local and remote control of individual direct expansion units, fan coils and production units. Management through the **manufacturer's thermostat** and from any **Android or iOS device that has the app**.



Individual units



Air heating and cooling



Pack format

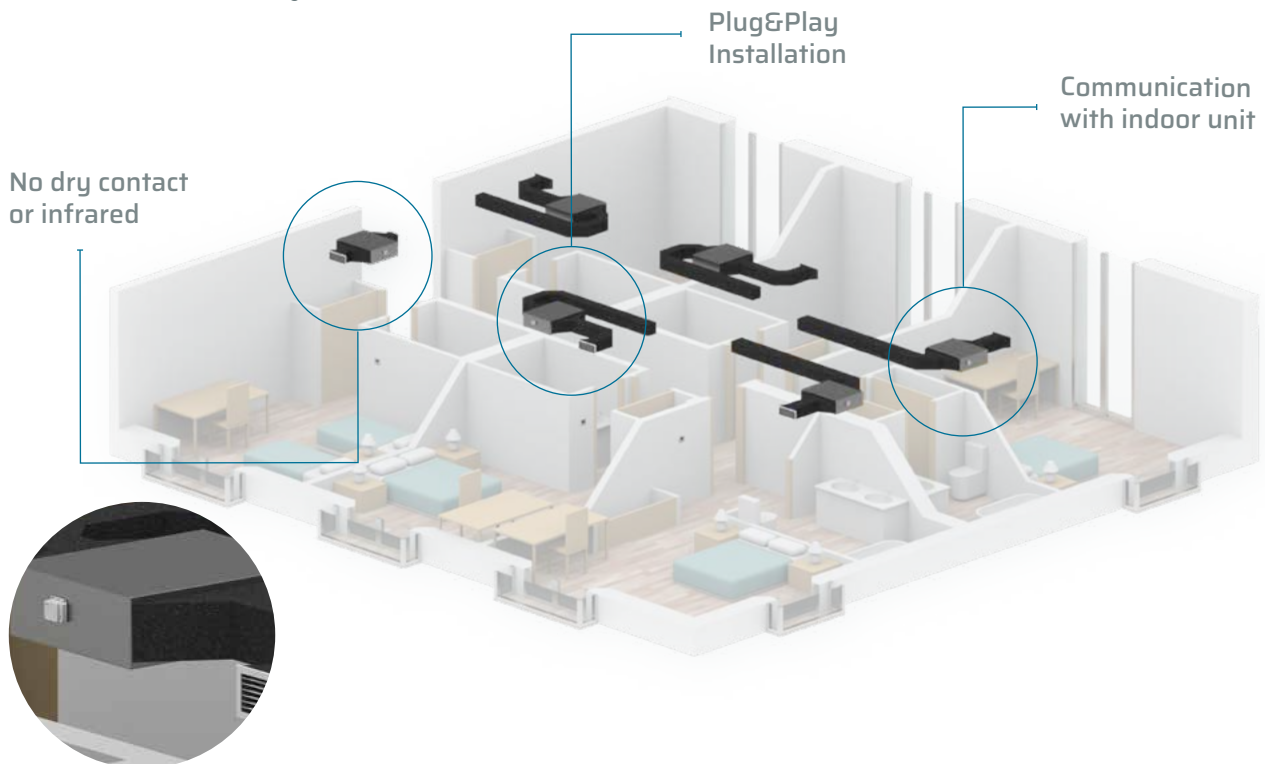

- **Easy to install**, it connects to the indoor unit in just minutes.
- **Control of the unit** with confirmation of actions and statuses.
- Maintains the **original manufacturer features intact by** communicating with the indoor unit.
- **Control of older units**, thereby providing a technology update.

DOWNLOAD THE APP

Discover **the free app Airzone Cloud**.



Airzone Cloud

Keep your unit up to date with the latest IoT trends and extend the life cycle of your system

	Aidoo PRO Inverter/VRF Air to water	Aidoo PRO Fancoil	Aidoo KNX Inverter/VRF	Aidoo Z-Wave Inverter/VRF	Aidoo Zigbee Inverter/VRF	Aidoo Wi-Fi Inverter/VRF
Indoor unit control	Communication gateway	3 speeds/ 0-10 V	Communication gateway	Communication gateway	Communication gateway	Communication gateway
Connectivity	Wi-Fi Dual 2.4/5 GHz	Wi-Fi Dual 2.4/5 GHz	KNX	Z-Wave	Zigbee	Wi-Fi 2.4 GHz
App	Yes	Yes	-	-	-	Yes
Settings	Airzone Cloud App	Airzone Cloud App	ETS	Z-Wave	Zigbee	Airzone Cloud App
Voice control	Yes	Yes	-	-	-	Yes
Airzone thermostat  New!	Yes	Yes	-	-	-	-
Power supply	External power supply at 12 Vdc ¹	220 Vac	Indoor unit and KNX network	Indoor unit	Indoor unit	Indoor unit
Digital input	On/Off	On/Off	3 configurable inputs	-	-	-
Auxiliary heat output	Yes	Yes	-	-	-	-
GYW input for smart thermostats	Yes*	-	-	-	-	-
RS485 integration port	Modbus and BACnet* MS/TP	Modbus and BACnet MS/TP	-	Modbus	Modbus	Modbus
REST API and driver integration	Yes	Yes	-	-	-	-
Cloud API	Yes	Yes	-	-	-	Yes

App

Full control from **the free Airzone Cloud app**.

- **Select scenes.**
- Set **time schedules** for scenes, temperature and operation mode.
- Integration with Amazon **Alexa** and **Google Assistant**.
- **Set-point temperature limitation** in cooling and heating modes.

Airtools

Access the Airtools² feature for **24/7 smart remote unit diagnostics** and real-time HVAC unit parameters and error codes.

¹ Power supply included. ² Only available for Aidoo Pro and Aidoo Wi-Fi.
*Only available for Inverter/VRF units.

Aidoo Pro Inverter/VRF

Compatible with ducted units, splits and cassettes. Aidoo Pro is a **powerful solution thanks to its use of the manufacturers' original protocols** and its high integration capacity.

- Communication via Wi-Fi Dual (2.4/5 GHz).
- Dry contact with a smart thermostat.
- Open window detection, occupancy detection and Eco mode.
- Detection of communication errors.
- Now **compatible with Blueface touchscreen thermostat**.

+ New!

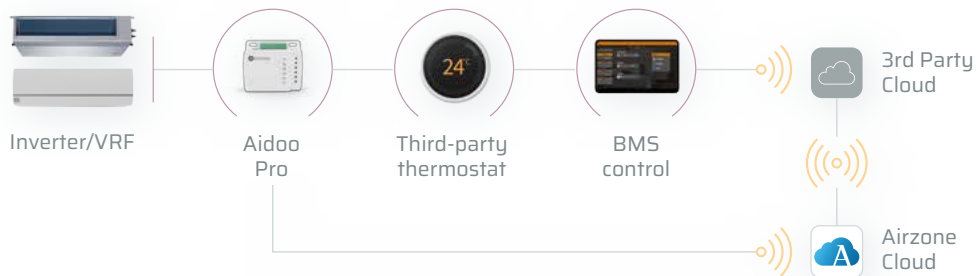

+ New! Aidoo Pro Air To Water



Aidoo Pro Air To Water is a device for the remote control of air to water units through the **Airzone Cloud app**. Thanks to its wide range of integration options, it allows the management of these units from home automation and building management systems (BMS).

- Multi-user and multi-session.
- Time scheduling of temperature and operation mode.

- Communication via Wi-Fi Dual (2.4/5 GHz).
- Two-way communication with the AC unit.
- Control of the different AC unit parameters.
- Detection of errors during communication.

Aidoo Pro Fancoil

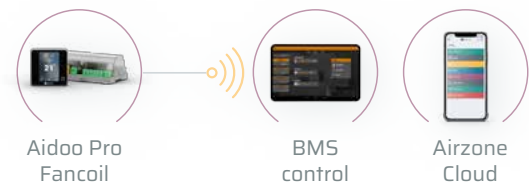

Allows **fan and valve control** for both 0-10 V units and units with up to 3 speeds.

- Communication via Wi-Fi Dual (2.4/5 GHz).
- On-demand control of all/nothing or 0-10 V solenoid valves.
- Three-speed or 0-10 V fan control.
- Open window detection, occupancy detection and Eco mode.
- Measurement of room temperature and cooling and heating battery temperature.
- Automatic mode change by supply temperature detection.

Aidoo Wi-Fi Inverter/VRF



Compatible with ducted units, splits and cassettes. Aidoo Wi-Fi is easy to install and configure. It enables **single-zone control of Inverter/VRF units, thanks to comprehensive two-way communication** with the indoor unit.

- Pro Cloud API.
- Bluetooth configuration.
- Communication via Wi-Fi 2.4 GHz.
- Port for integration via the Modbus protocol.

Aidoo Z-Wave Inverter/VRF



Gateway for two-way control and integration of **Inverter/VRF units in Z-Wave systems.**

- External power supply via the indoor unit/ with an external power source.
- Port for integration via the Modbus protocol.

- Z-Wave network communication.
- Detection of errors during communication.
- Control of unit parameters.

Aidoo KNX Inverter/VRF

KNX certified product

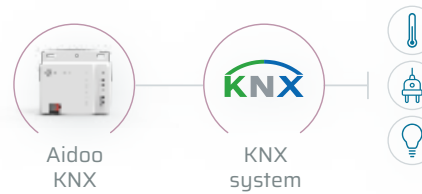

Gateway for two-way **control and integration of Inverter/VRF units in KNX TP-1 control systems.** Easy configuration from ETS, Aidoo KNX enables control of Inverter/VRF units.

- Control of any unit connected in a KNX system.
- Control of unit parameters.
- KNX control and standard KNX data.
- 3 configurable digital inputs.
- Detection of communication errors.

New! Aidoo Zigbee Inverter/VRF



Gateway for **home automation integration of Inverter/VRF units in Zigbee systems.**

Aidoo Zigbee is certified by the Connectivity Standards Alliance allowing interoperability on any Zigbee network according to Alliance standards. As a permanently powered node, it acts as a repeater and improves network reliability.

- Two-way communication with the AC unit.
- Detection of errors during communication.
- External power supply via the indoor unit/ with an external power source.
- Control of unit parameters.
- Port for integration via the Modbus protocol.

Zoned control system

Zoned control for underfloor heating and cooling installations.

The most efficient and cost-effective way to control underfloor heating and cooling is with Airzone thermostatic heads. Thanks to the Flexa 4.0 system, **the floor's thermal inertia is used to achieve greater savings.**



Boiler



Air to water

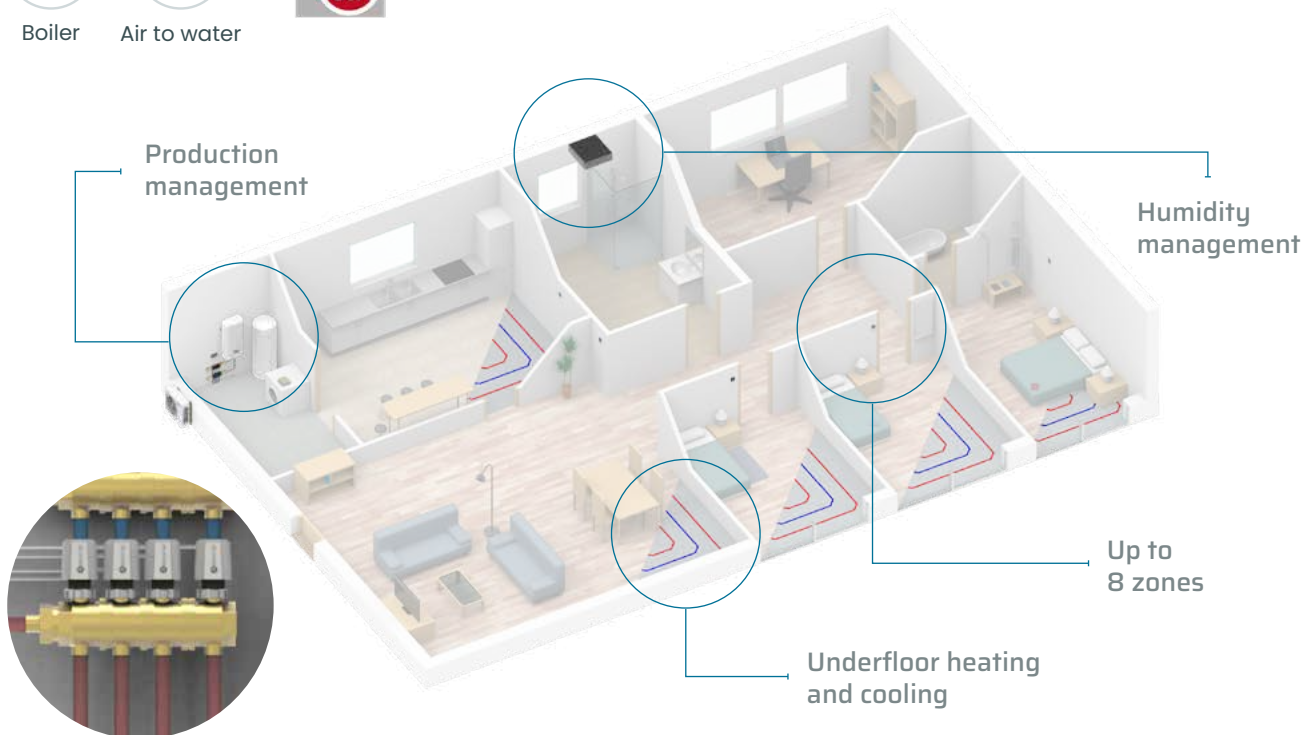

- Control of the **comfort temperature** in each zone.
- **Anti-condensation** control with measurement of humidity in the zone, supply temperature and control of the dehumidifier.
- Limitation of minimum and maximum temperatures for efficient control through the **Eco-Adapt function**.
- **Optimization of comfort** with smart control of the floor's thermal inertia.
- **Production management by means of communication gateways** and action on recirculation pumps.
- **Airzone thermostatic heads** supplied at 230 Vac for managing the valves in each zone*.

* Third-party heads with an external power supply at 110/230 Vac (50/60 Hz) can be used.

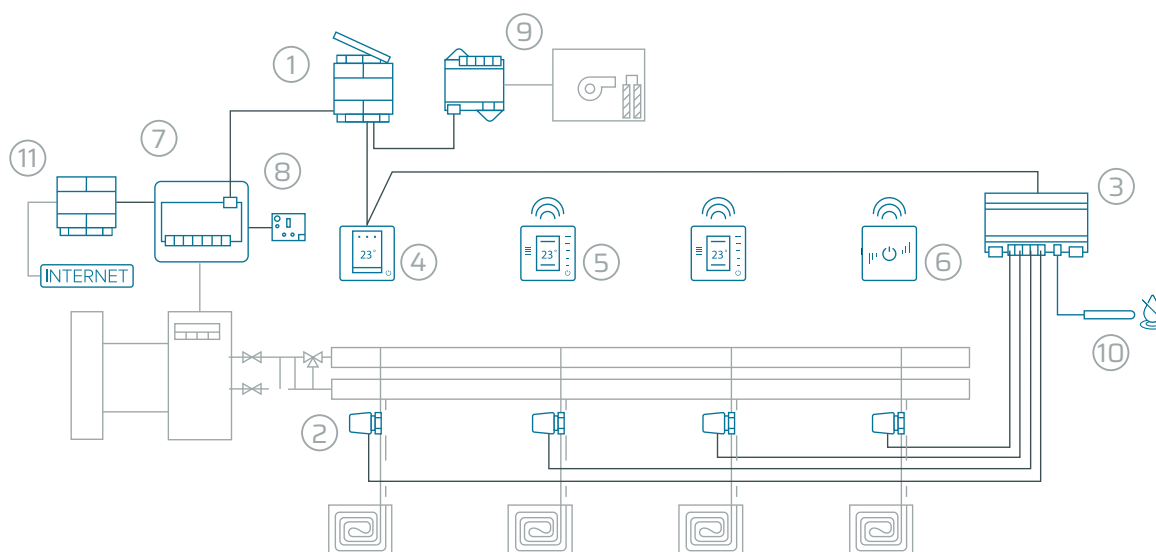

Reference	Description	Units
1	AZCE8CB1DIN Airzone main control board for Flexa 4.0 using DIN rail	1
2	AZX6ACTIVALC Airzone wired 110/230V VALC thermostatic head for radiant elements M30x1.5 mm	4
3	AZCE8CM1VALC Airzone Flexa 4.0 control module of 110/230V VALC wired valves (Flexa 4.0)	1
4	AZCE6BLUEZEROC [B/N] Airzone Flexa Blueface Zero wired thermostat [black/white]	1
5	AZCE6THINKR [B/N] Airzone Flexa Think monochrome wireless thermostat [black/white]	2
6	AZCE6LITE [C/R][B/N] Airzone Flexa Lite [wired/wireless] simplified thermostat [black/white]	1
7	AZX6CCPGAWI Airzone hydronic production control board	1
8	AZX6GAW [XXX] Airzone air to water gateway - [brand]	1
9	AZCE8CM1DRY* Airzone Flexa 4.0 dehumidifier control module	1
10	AZX6SONDPROTECT Airzone temperature metallic probe in sheath	1
11	AZX6WSPHUB Webserver HUB Airzone Cloud Dual 2.4-5 GHz/Ethernet	1



Independent temperatures



Time schedules



Relative humidity



Remote management*



Weather forecast*



Residential and tertiary

Reversible floor control

Flexa 4.0 can be used with underfloor heating and cooling systems for **use 365 days a year.**

Safety functions

Thanks to its **anti-condensation, anti-freezing and anti-scale functions**, the system is protected from condensation or freezing of pipes.

* Consult availability.

* Applicable if the system has an Airzone Cloud Webserver.

An integrated solution

Compatibility with **the main BMS/home automation and IoT technologies.**

- Airzone Cloud app.
- Amazon Alexa, Google Assistant and SmartThings voice assistants.
- Modbus protocol.
- Lutron and KNX integration gateways.
- Drivers and plugins: Control4, Crestron, Eedomus, Fibaro, Jeedom and RTI.
- Cloud API and REST API.

Zoned control system

Zoned control for radiators.

Airzone wireless thermostatic heads enable zoned radiator control. An easy-to-install **Plug&Play solution**. Flexa 4.0 is also suitable for central heating in buildings.



Boiler



Air to water

Control of up to 10 radiators

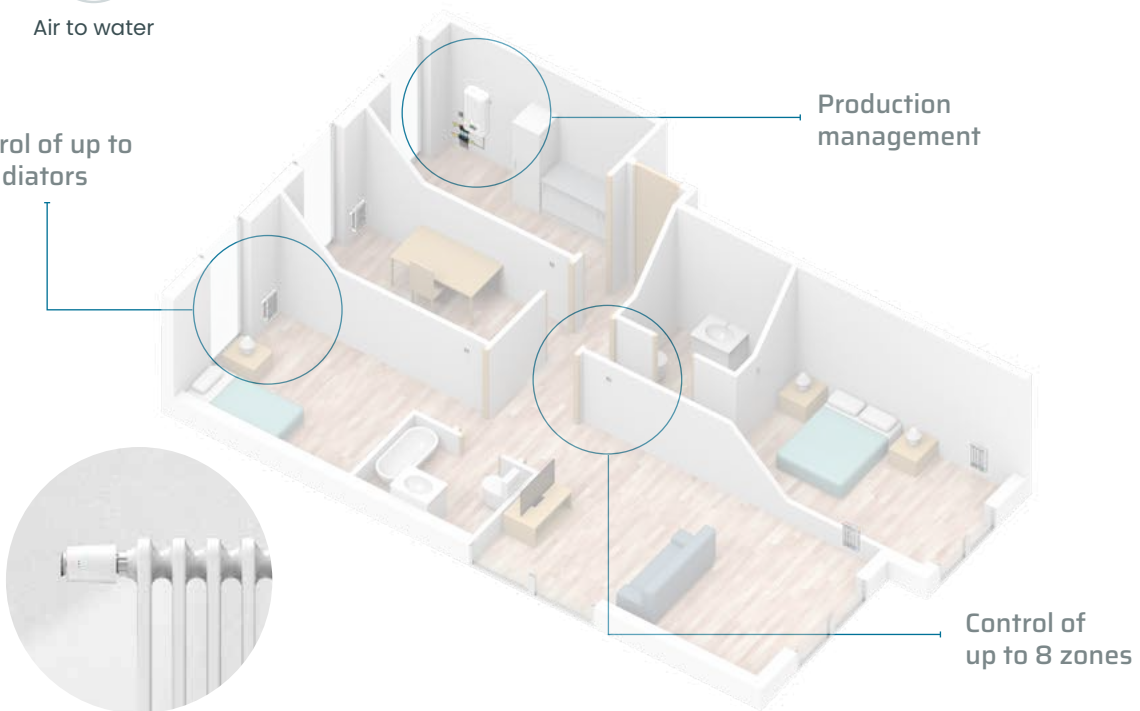

- Airzone **wireless thermostatic** heads with comfort temperature regulation and indicator in each zone.
- Limitation of minimum and maximum temperatures for efficient control through the **Eco-Adapt function**.
- **Optimization of comfort** with proportional control of the opening of the radiator valve depending on room temperature.
- Adapters for connecting the head with

valves of different diameters.

- Improved control of the system and reduced energy consumption thanks to **production management via communication gateways** and action on recirculation pumps.

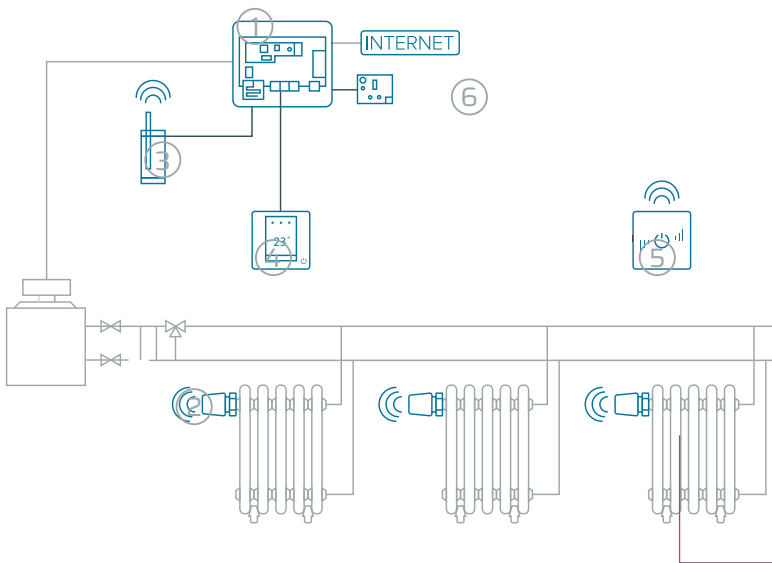

We adapt to your radiator model!



You can adapt the system to different radiators thanks to the adapters included for the different valves available on the market.

Reference	Description	Qty
1 AZRA6CB1RADW	Airzone radiant VALR cloud dual 2.4-5G system for radiators main board	1
2 AZX6ACTIVALR	Airzone wireless thermostatic valve actuator VALR for radiators	3
3 AZX6CM1VALR	Airzone control module for wireless valves VALR - 8 zones	1
4 AZRA6BLUEFACEC [B/N]	Airzone Radiant365 Blueface wired thermostat [white/black]	1
5 AZRA6LITE [C/R] [B/N]	Airzone Radiant365 Lite Thermostat [wired/wireless][white/black]	1
6 AZX6GAW [XXX]	Airzone - [brand] air to water hp gateway	1



Independent temperatures



Time schedules



Remote management*



Weather forecasts*



Residential and commercial

Secure installation

The **child safety function** prevents involuntary activation of the device and **the anti-freeze functions** protect the system against frost in the pipes

Improved aesthetics

Airzone thermostat heads have a **modern and simple design** that fits in with any interior. Their **LED screen** shows the set temperature, battery status and wireless network coverage. It is possible to add one user interface per zone.

An integrated solution

Compatible with **the main BMS, home automation and IoT technologies.**

- Airzone Cloud Application.
- Voice assistants Amazon Alexa or Google Assistant.
- Drivers and plugins: Control4, Crestron, Eedomus, Fibaro, Jeedom and RTI.
- Cloud API and REST API.

* Applicable when the System has an Airzone Cloud Webserver.

Zoned control system

Zoning for ducted systems.

The Flexa 4.0 system is suitable for **rigid and flexible ducted installations** for the independent control of each zone.



Inverter



VRF



Boiler



22184

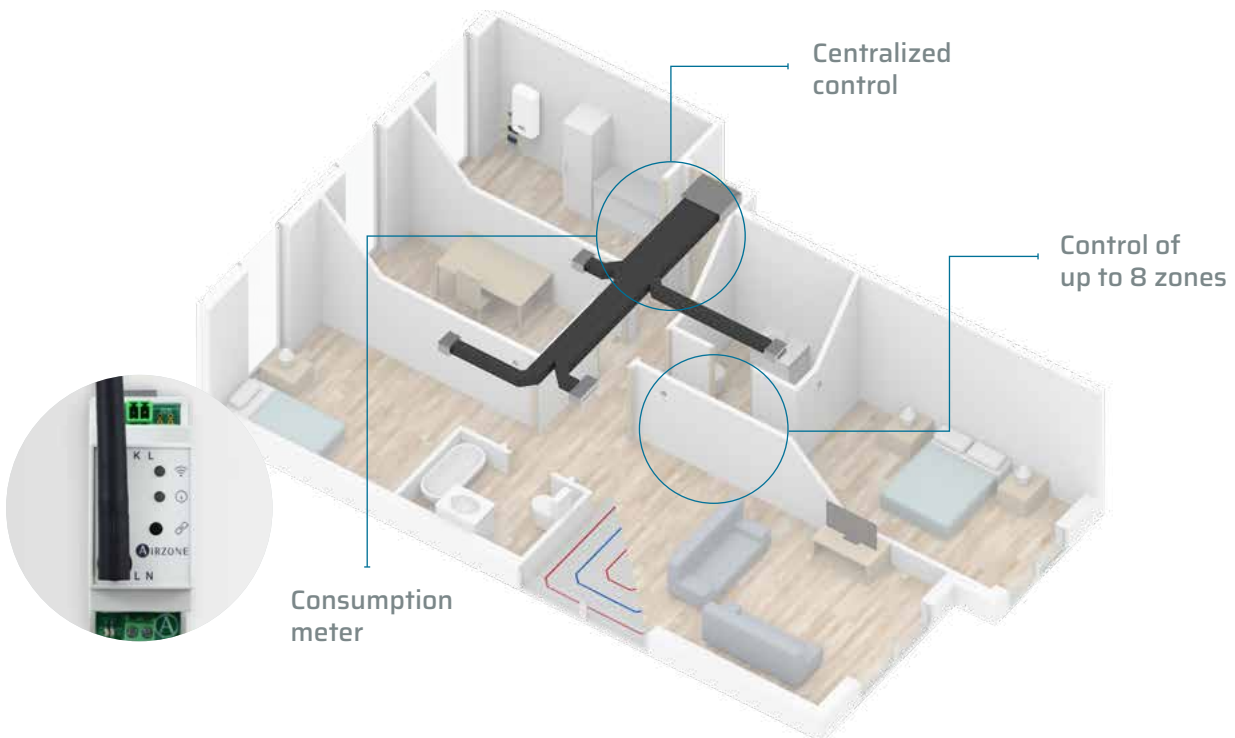

- Individual management of the **comfort temperature** in each zone.
- Limitation of minimum and maximum temperatures for efficient control through the **Eco-Adapt function**.
- **Q-Adapt** configuration for fan regulation with 5 presets.
- **Dynamic control** of the indoor unit according to demand.
- Controlled mechanical ventilation (**CMV**) management.
- **Management of production** and recirculation pumps.
- It features a **programmable and configurable output**.
- **Advanced configuration** through the app via Bluetooth.

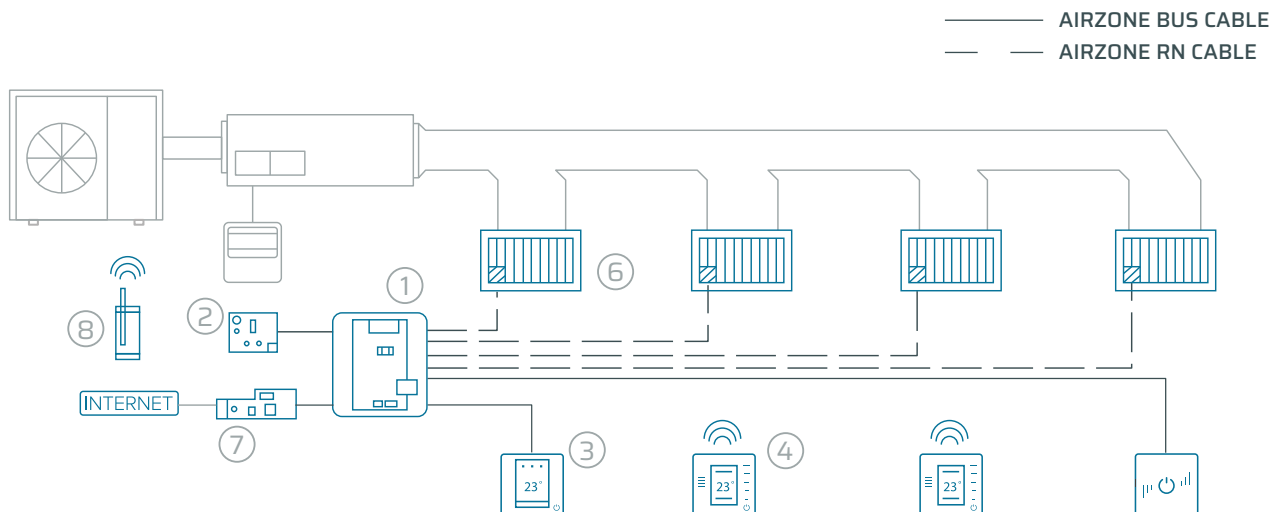

Reference	Description	Units
1 AZCE8CB1MOT	Flexa 4.0 main control board - 8 zones	1
2 AZX6GTC [XXX]	Airzone 3.0 controller gateway - [brand]	1
3 AZCE6BLUEZEROC [B/N]	Airzone Flexa Blueface Zero wired thermostat [black/white]	1
4 AZCE6THINKR [B/N]	Airzone Flexa Think monochrome wireless thermostat [black/white]	2
5 AZCE6LITE [C/R] [B/N]	Airzone Flexa Lite [wired/wireless] simplified thermostat [black/white]	1
6 RINT[LONGITUD] [ALTURA] BKMRE	Triple smart regulation grille white	4
7 AZX6WSC5GER	Airzone Cloud Webserver Wi-Fi Dual 2.4-5 GHz	1
8 AZX6ACCON	Airzone consumption meter	1

Independent temperatures

Time schedules

Eco-Adapt function

Remote management*

Weather forecast*

Residential and tertiary

New! Configuration from the app

The new AZCE8CB1MOT main control board allows **easy configuration of the system through the app thanks to the configuration wizard**. It uses a bluetooth connection, facilitating on-site start-up in the absence of a Wi-Fi connection.

Consumption information

Thanks to the electric meter, you can view the energy consumption of your single-phase HVAC unit on the application's own thermostat or through the Airzone Cloud app.

An integrated solution

Compatibility with **the main BMS/home automation and IoT technologies**.

- Airzone Cloud app.
- Amazon Alexa, Google Assistant and SmartThings voice assistants.
- Modbus protocol.
- BACnet, Lutron and KNX integration gateways.
- Drivers and plugins: Control4, Crestron, Eedomus, Fibaro, Jeedom and RTI.
- Cloud API and REST API.

* Applicable if the system has an Airzone Cloud Webserver.

Zoned control system

Zoned control for **ducted HVAC applications, underfloor heating and cooling and radiators.**

Enjoy complete centralized control of the entire application by adding **control of radiant elements, the production unit and the recirculation pumps** to your zoned system.



Inverter



VRF



Boiler



Air to water

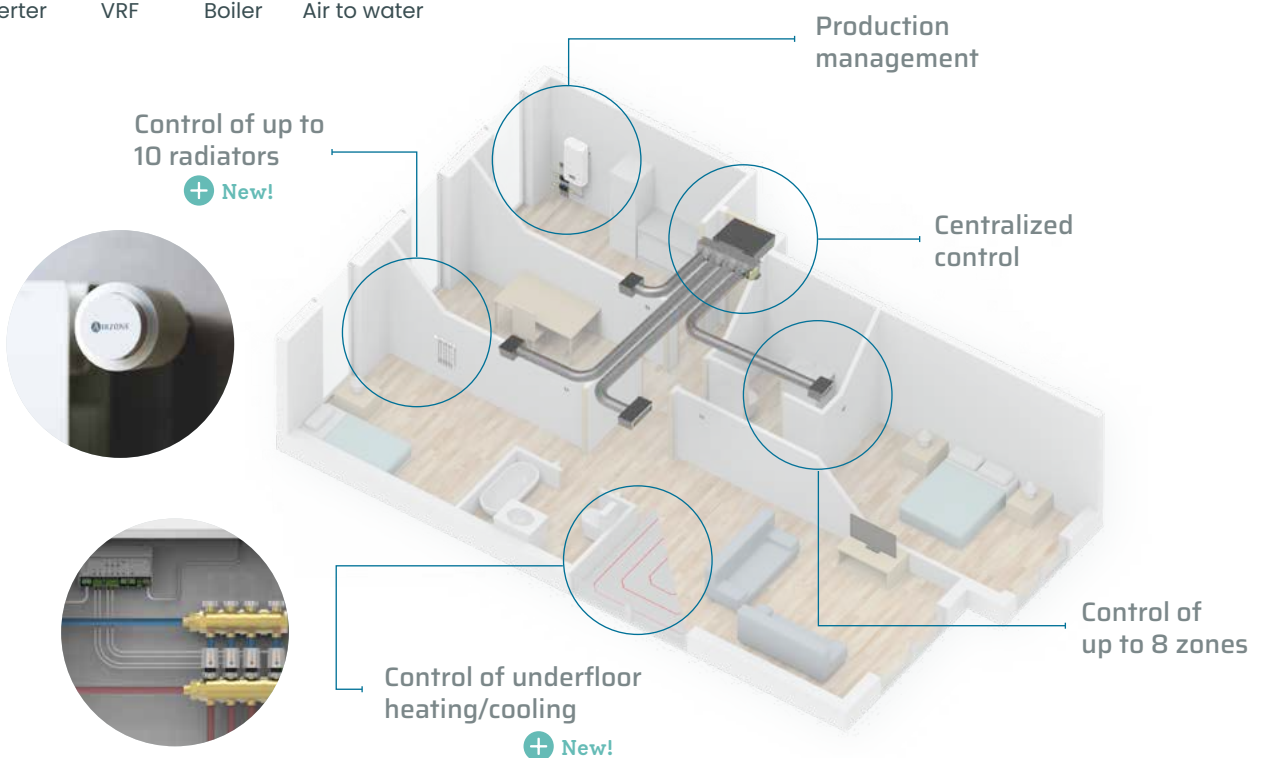

A single thermostat for air conditioning and underfloor heating and cooling

With a single thermostat per zone, you can easily control air conditioning, underfloor heating and cooling and radiators. **The combined mode makes smart use of the heating stages** to achieve thermal comfort conditions in the shortest possible time.

- Control of **air, underfloor heating and cooling and radiator stages.**
- Management of **production and recirculation pumps.**
- Optimization of comfort with smart control of the **floor's thermal inertia.**
- **Anti-freezing safety function** that prevents the freezing of pipes.
- **Control of the comfort temperature** in each zone.

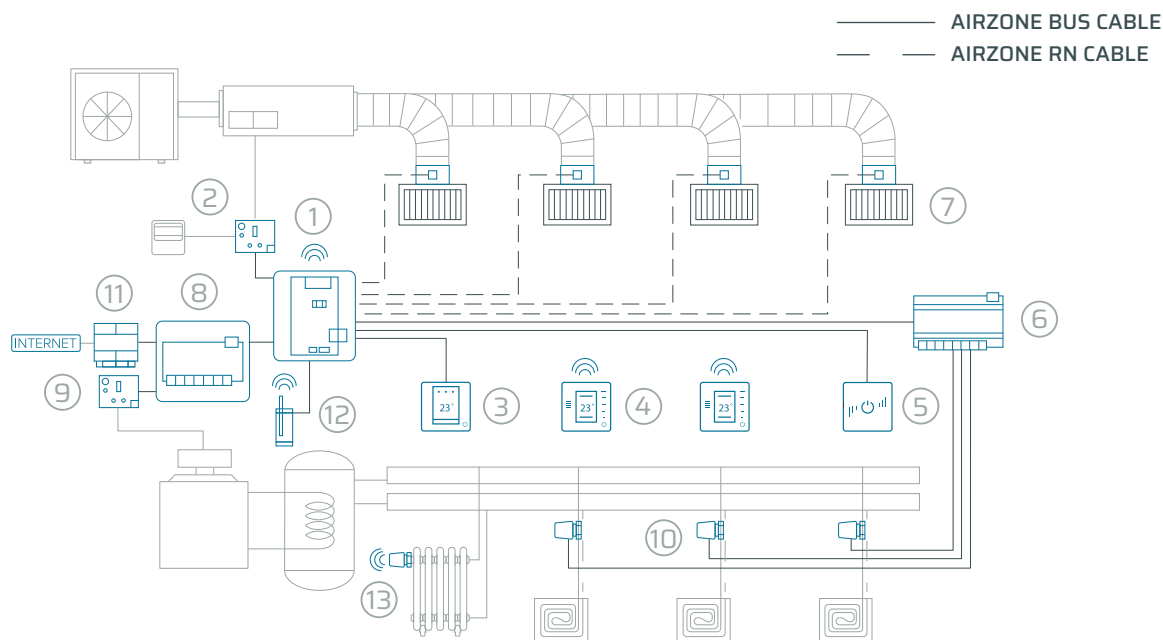

Reference	Description	Units
1	AZCE8CB1MOT Airzone Flexa 4.0 main control board	1
2	AZX6GTC [XXX] Airzone 3.0 controller gateway - [brand]	1
3	AZCE6BLUEZEROC [B/N] Airzone Flexa Blueface Zero wired thermostat [black/white]	1
4	AZCE6THINKR [B/N] Airzone Flexa Think monochrome wireless thermostat [black/white]	2
5	AZCE6LITE [C/R] [B/N] Airzone Flexa Lite [wired/wireless] simplified thermostat [black/white]	1
6	AZCE8CMIVALC Airzone control module of 110/230V VALC wired valves	1
7	RINT[LONGITUD] [ALTURA] BKMRE Triple smart regulation grille white	4
8	AZX6CCPGAWI Airzone hydronic production control board	1
9	AZX6GAW [XXX] Airzone air to water gateway - [brand]	1
10	AZX6AC1VALC Airzone wired 110/230V VALC thermostatic head for radiant elements M30x1.5 mm	3
11	AZX6WSPHUB Webserver HUB Airzone Cloud Dual 2.4-5 GHz/Ethernet	1
12	AZCE8CMIVALR Airzone wireless VALR valve control module	1
13	AZX6AC1VALR Airzone VALR wireless thermostatic head for radiators	1



Independent temperatures



Time schedules



Combined control



Remote management*



Weather forecast*



Residential and tertiary

More comfort, less time

By combining the operation of water, air and radiant stages, you can achieve thermal comfort conditions in the shortest possible time.

Now you can control different types of radiant cooling and heating sources (underfloor heating and cooling, electric underfloor heating and cooling, ceiling cooling, water or electric radiators) and reduce installation time thanks to the new radiant elements module.

More efficient heating

The production control board enables automated management of zones with demand. The production of the air to water system and the recirculation pumps will therefore work, avoiding overconsumption.

*Applicable if the system has an Airzone Cloud Webserver.

Zoned control system

Motorized plenum for zoning and air quality in installations with circular ducts

Easyzone IAQ is the **Plug&Play solution** for applying zone control to an indoor unit with flexible ducts. **It controls 2 to 8 zones** independently and from anywhere with the **new Airzone Cloud app**. Available as an open system, Flexa 3.0.



Control of indoor air quality

			
Direct expansion	VRF	Chiller water	221183

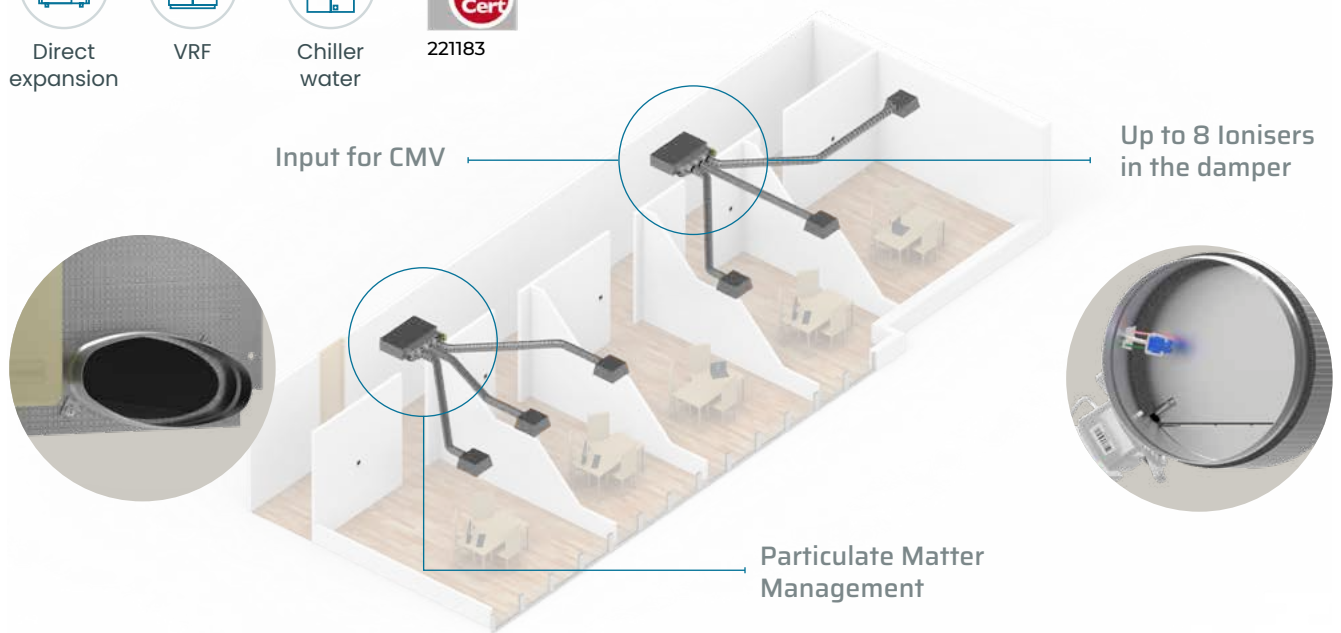

Easyzone now also purifies the air by zone

Easyzone **purifies and improves the indoor air quality** of each zone. Each motorised damper includes an ioniser that purifies the air, based on the air quality level detected.

- Dynamic control of **set-point temperatures** for better energy efficiency.
- Limitation of minimum and maximum temperatures for effective control with the **Eco-Adapt function**.
- Custom-made plenum for each indoor unit, **Plug&Play**.
- 3 plenum models available: **Standard + CMV, Slim + CMV and Medium**.
- Dynamic control of set-point temperatures with the **Q-Adapt function**.

CMV: Controlled mechanical ventilation

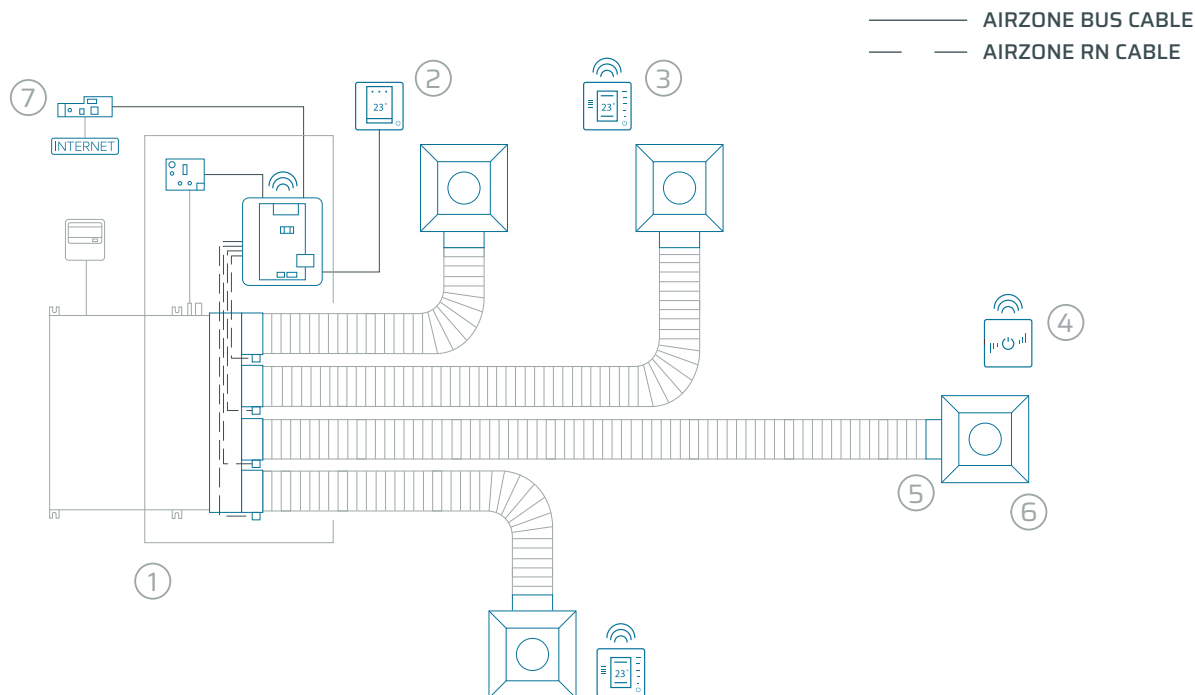

Reference	Description	Qty
1	AZEZ8 [XXX] [ST/SL/BS] 4x [200/150] Easyzone IAQ [Standard + CMV / Slim + CMV / Medium] IB8 [brand] 4x [200/150] 01M Airzone - [brand] controller gateway Airzone main controller of the Flexa 4.0 system - Innobus Pro8 - 8 zones Ioniser for each damper and integrated sensor	1
2	AZCE6BLUEZEROC [B/N] Airzone Blueface Zero wired thermostat [white/black]	1
3	AZCE6THINKR [B/N] Airzone Think wireless monochrome thermostat [white/black]	2
4	AZCE6LITE [C/R] [B/N] Airzone Lite Thermostat [wired/wireless][white/black]	1
5	PLEAROT Plenum for insulated rotating diffuser	4
6	DRPL [XX] B [XX] Rotating diffuser on plate for white modular ceiling	4
7	AZX6WSC5GER Webserver Airzone Cloud Wi-Fi Dual 2.4-5 GHz	1



Independent temperatures



Time schedules



Air quality



Remote management*



Weather forecasts*



Residential and commercial

New!



Dampers with ionisers

Each motorised damper has an **integrated flow control mechanism**, to which an **ioniser** is added.

Renewal of the air (CMV)

Easyzone makes it possible to renew the air in the application independently and autonomously, using the same ductwork.

An integrated solution

Compatible with **the main BMS, home automation and IoT technologies.**

- Airzone Cloud Application.
- Voice assistants Amazon Alexa or Google Assistant.
- Modbus Protocol.
- BACnet, Lutron and KNX integration gateways.
- Drivers and plugins: Control4, Crestron, Eedomus, Fibaro, Jeedom and RTI.
- Cloud API and REST API.

* Applicable when the System has an Airzone Cloud Webserver.

Zoned control system

Motorized plenum for zoning and air quality in mixed installations: ducted HVAC, underfloor heating and cooling and radiators.

Easyzone IAQ is a complete system. Add **control of radiant elements, the production unit and the recirculation pumps** to your zoned system. Centralized control for the entire application.

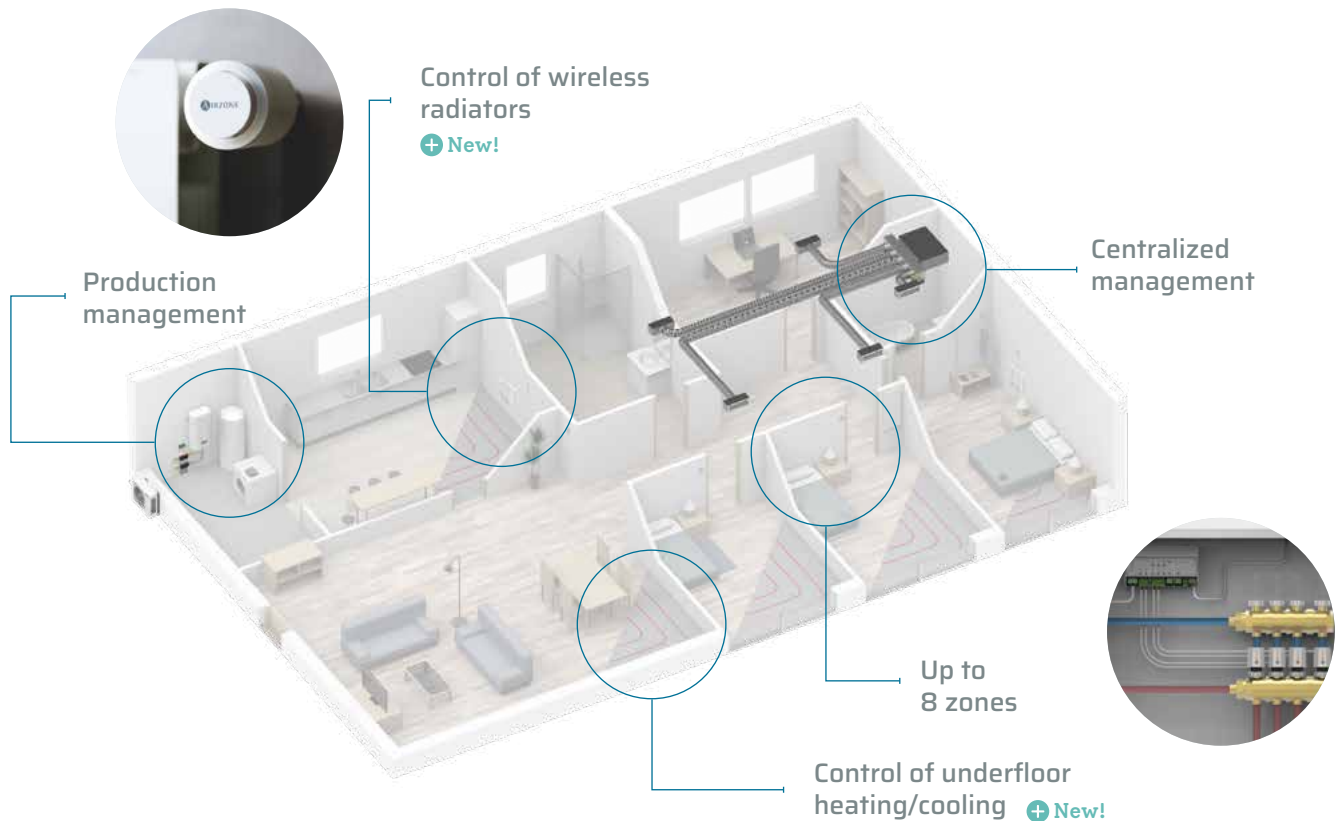
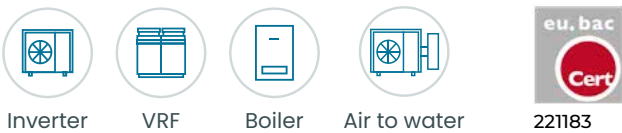

- **Optimization of comfort** with smart control of the floor's thermal inertia.
- **Anti-freezing safety function** that prevents the freezing of pipes.
- Ionization-based indoor **air purification and quality control** system.
- Control of the **comfort temperature** in each zone.

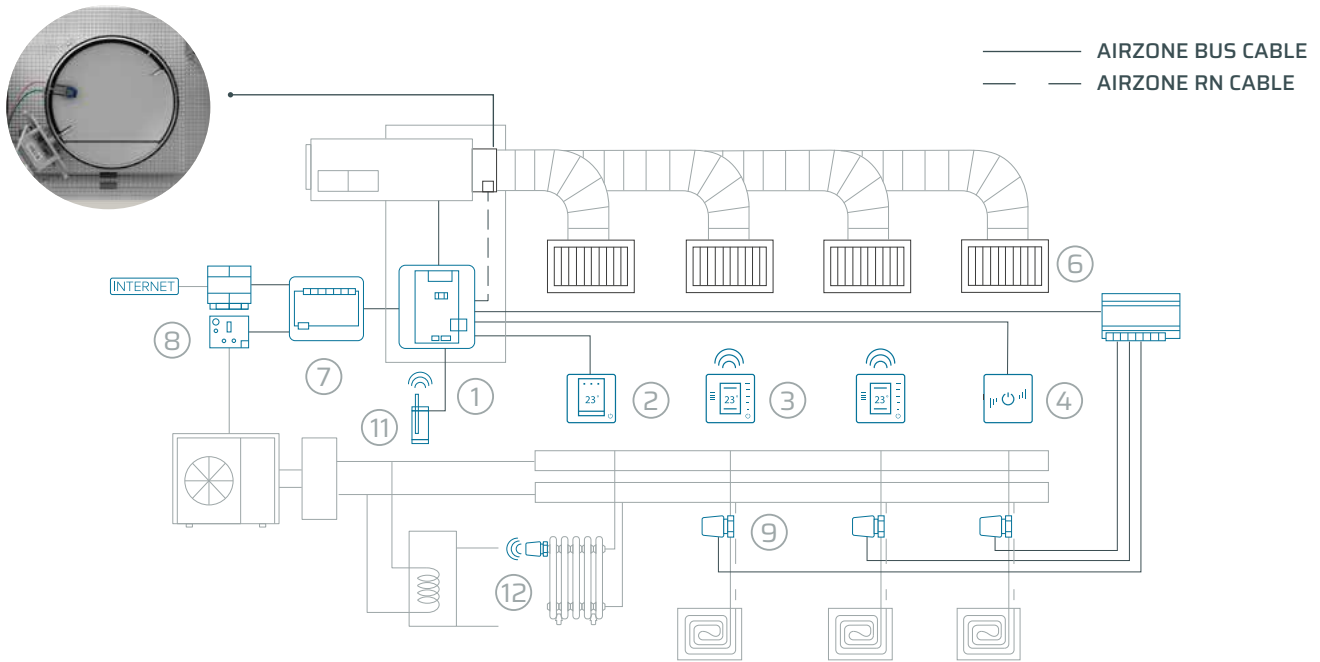

Reference	Description	Units
1	AZEZ8 [XXX] [ST/SL/BS] 4x [200/150] Easyzone IAQ [Standard+ CMV / Slim+ CMV / Medium] IB8 [brand] 4x [200/150] 01M Airzone 3.0 controller gateway - [brand] Airzone Flexa 4.0 - Innobus Pro8 main control board - 8 zones Ionizer by damper and integrated sensor	1
2	AZCE6BLUEZEROC [B/N] Airzone Flexa Blueface Zero wired thermostat [black/white]	1
3	AZCE6THINKR [B/N] Airzone Flexa Think monochrome wireless thermostat [black/white]	2
4	AZCE6LITE [C/R] [B/N] Airzone Flexa Lite [wired/wireless] simplified thermostat [black/white]	1
5	AZCE8CMIVALC Airzone control module of 110/230V VALC wired valves	1
6	RDHV[LENGTH][HEIGHT] BXX Horizontal-vertical double deflection supply grille white	4
7	AZX6CCPGAWI Airzone hydronic production control board	1
8	AZX6GAW [XXX] Airzone air to water gateway - [brand]	1
9	AZX6ACTIVALC Airzone wired 110/230V VALC thermostatic head for radiant elements M30x1.5 mm	4
10	AZX6WSPHUB Webserver HUB Airzone Cloud Dual 2.4-5 GHz/Ethernet	1
11	AZCE8CMIVALR Airzone wireless VALR valve control module	1
12	AZX6ACTIVALR Airzone VALR wireless thermostatic head for radiators	1



Independent temperatures



Time schedules



Combined control



Remote management*



Weather forecast*



Air quality

Combined control

With the control module of radiant elements, you can **combine the operation of water, air and radiant stages**. The combined mode makes it possible to achieve thermal comfort conditions in the shortest possible time.

Optimized production

Through the production control board, Easyzone IAQ **automatically manages the production of the air to water system and recirculation pumps** according to the zones with demand, avoiding overconsumption.

An integrated solution

Compatibility with **the main BMS/home automation and IoT technologies**.

- Airzone Cloud app.
- Amazon Alexa, Google Assistant and SmartThings voice assistants.
- Modbus protocol.
- BACnet, Lutron and KNX integration gateways.
- Drivers and plugins: Control4, Crestron, Eedomus, Fibaro, Jeedom and RTI.
- Cloud API and REST API.

* Applicable if the system has an Airzone Cloud Webserver.

Zoned control system

Centralized management through seamless integration.

Acuazone is ideal for **the management of hydraulic applications with up to 32 independent zones**, with the possibility of combining underfloor **heating or cooling**, as well as all the associated **individual units** (cassettes, wall splits, consoles, etc.). Available in open system (without plenum) to be mounted and connected.

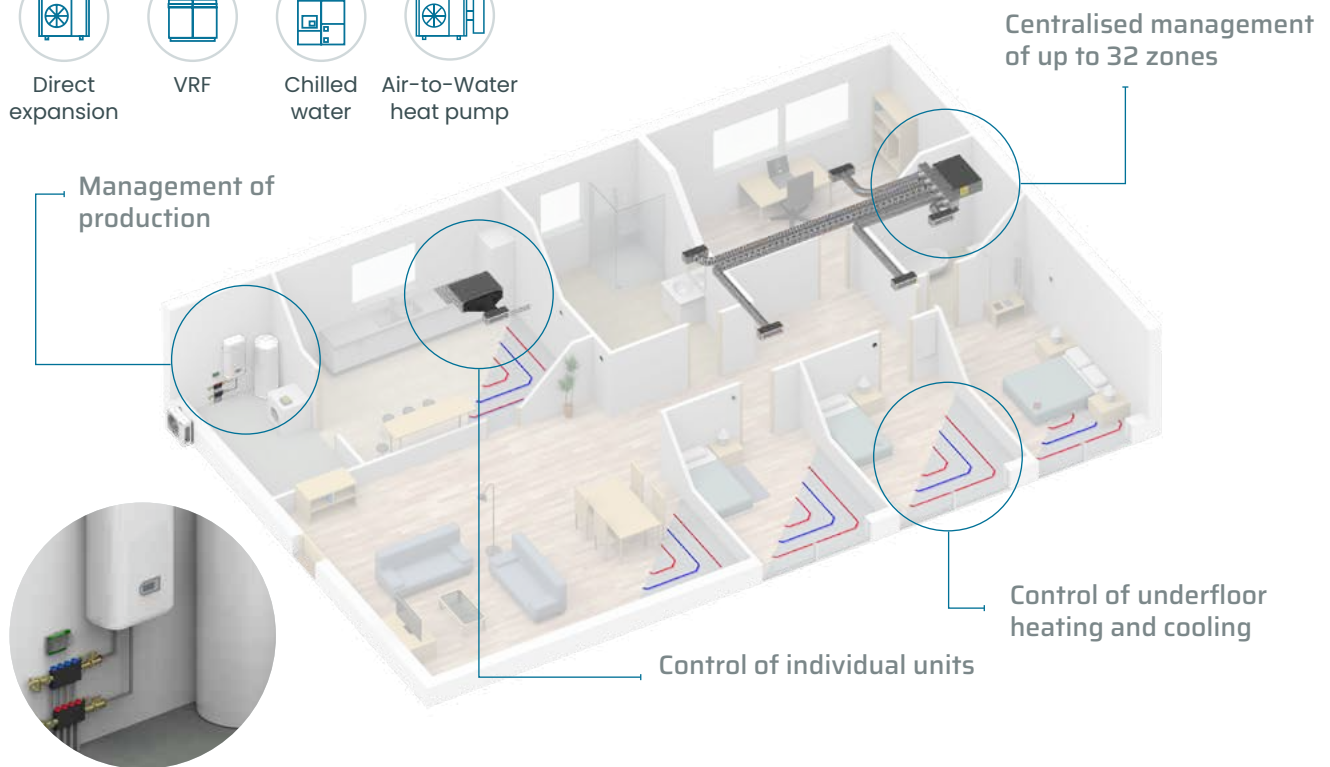

- **Individual control** of set-point temperatures by zone.
- **Anti-condensation** control with zone humidity measurement, supply air temperature and dehumidifier control.
- **Responsible management thanks to the Eco-Adapt functionality:** definition of the maximum temperature in heating and the minimum temperature in cooling.
- Optimum comfort thanks to **the combined regulation of the air and the underfloor heating and cooling.**
- **Rabbit and occupancy** contacts per zone to shut off heating and cooling in the room without affecting other zones.
- **Frost protection function** which prevents frost in the pipes and prolongs the life of the system.

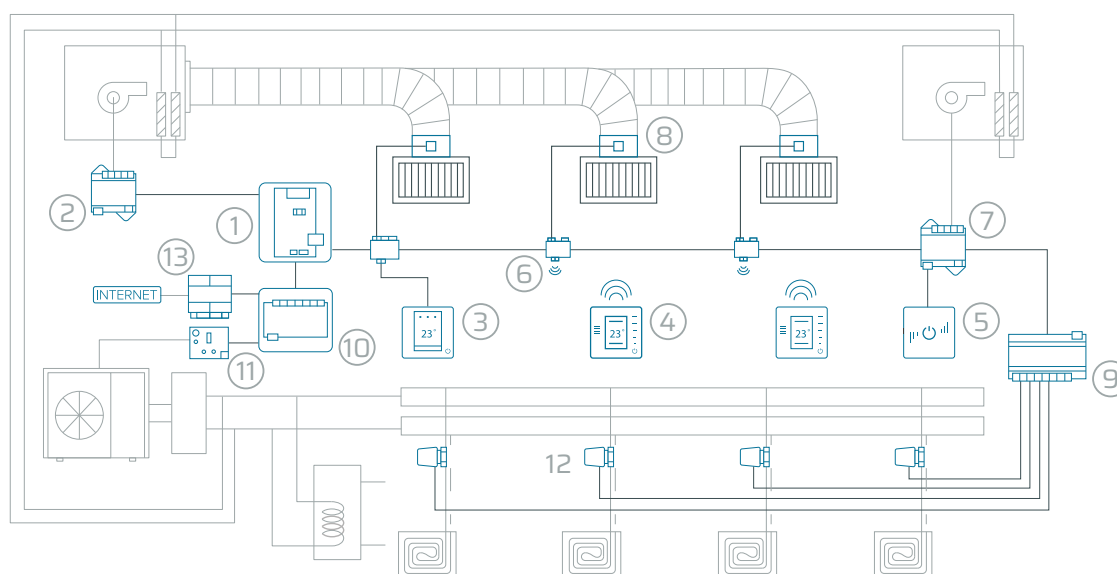

Reference	Description	Qty	
1	AZDI6ACUAZONE	Airzone Acuazone main control board - 32 zones	1
2	AZX6010VOLTSZ	Airzone 0-10V fan coil control gateway	1
3	AZDI6BLUEZEROC [B/N]	Airzone Acuazone Blueface Zero wired thermostat [white/black]	1
4	AZDI6THINKR [B/N]	Airzone Acuazone Think wireless monochrome thermostat [white/black]	2
5	AZDI6LITE [C/R] [B/N]	Airzone Acuazone Lite Thermostat [wired/wireless][white/black]	1
6	AZDI6MZZON [C/R]	Airzone actuator zone module [wired/wireless]	3
7	AZDI6MCFAN [C/R]	Airzone 3 speed fan coil individual unit zone module [wired/wireless]	1
8	CPC [DIAMETER] MTE	Motorised circular duct damper	3
9	AZDI6OUTPUT8	Airzone control module of radiant elements - 32 zones	1
10	AZX6CCPGAWI	Airzone hydraulic production control board	1
11	AZX6GAW [XXX]	Airzone - [brand] air to water hp gateway	1
12	AZX6ACTIVALC	Airzone wired thermostatic valve actuator 110/230v VALC for radiant elements	4
13	AZX6WSPHUB	Airzone Cloud Dual Webserver HUB 2.4-5G - Ethernet	1



Independent temperatures



Time schedules



Combined control



Remote management*



Weather forecasts*



Residential and commercial

A versatile solution

Acuazone adapts to the most complex applications by allowing efficient and intuitive integration. Particularly appealing for commercial buildings, this system offers a wide variety of combinations.

Dynamic control

The combined stage makes it possible to control the units of different thermal emitters and thus to optimise the operation of the mixing valve with the control of the temperature of the water produced.

* Applicable when the System has an Airzone Cloud Webserver.

An integrated solution

Compatibility with the main **BMS, home automation and IoT technologies.**

- Airzone Cloud Application.
- Voice assistants Amazon Alexa or Google Assistant.
- Modbus Protocol.
- KNX, BACnet or WAGO integration gateways.
- Drivers: Control4, Crestron, Eedomus, Fibaro, Jeedom and RTI.
- Cloud API and REST API.

2 tubes 2 wires

A smart solution for **2-tubes, 2-wire chilled water** applications

Plug&Play solution thanks to a motorised plenum which allows **zoned management of a 2-tube, 2-wire Fan coil unit**. In this sense, it will be possible to connect an auxiliary electric resistance heater. The electronics of this system are recognised by the European eu.bac energy improvement certification.

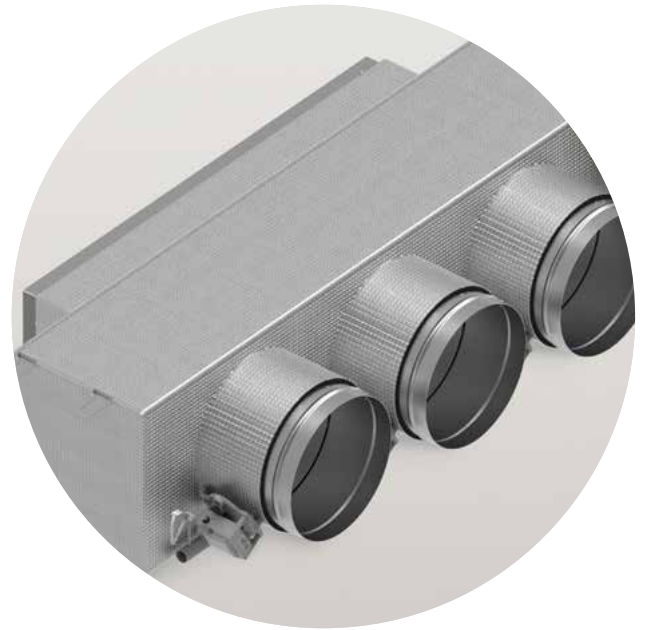

Chilled water

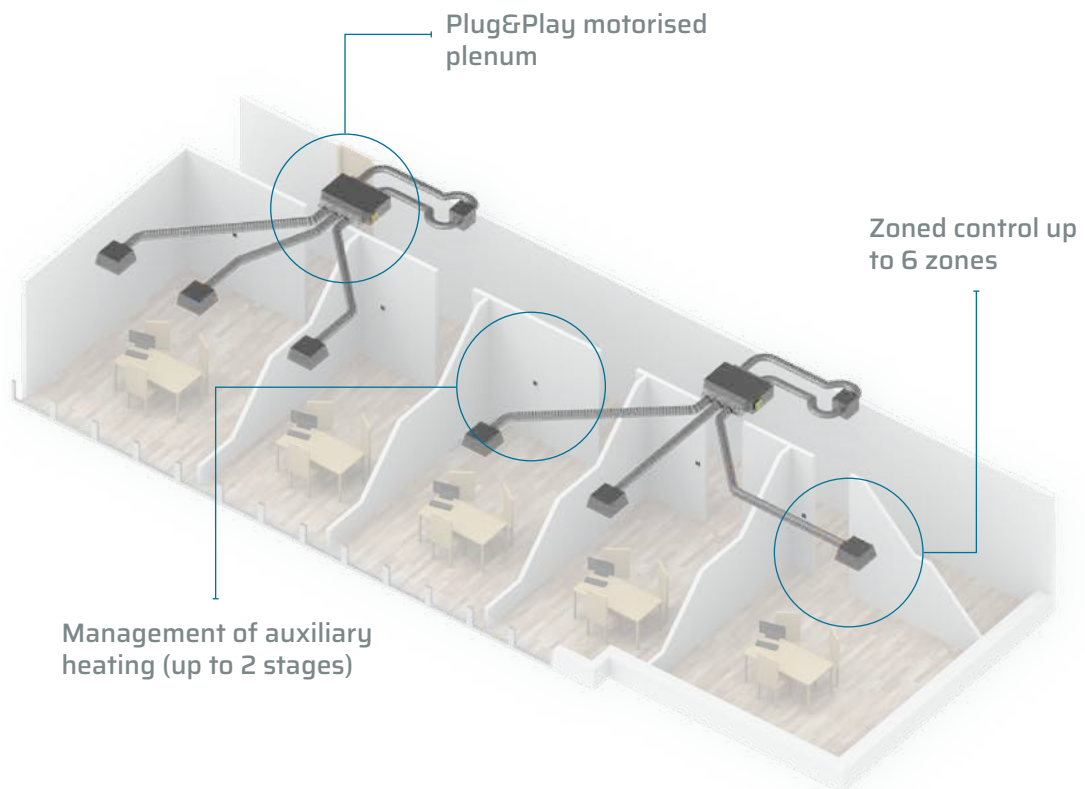

- **Smart management of the ventilation speed** of the air conditioning units to provide thermal comfort and adapt it according to demand. Possibility of managing 3-speed or proportional 0-10 V motors.
- **Auto mode:** Automatically alternates between cooling and heating, depending on overall demand.
- Possibility of managing a **2-tubes, 2-wires configuration** with electric battery in order to control an auxiliary heater.
- Improved energy performance thanks to the **eu.bac certified** Airzone Central V1.3 system.
- **Fewer indoor units:** with an average of 1 unit for 4 treated zones, the number of indoor units in the project is divided by 4.

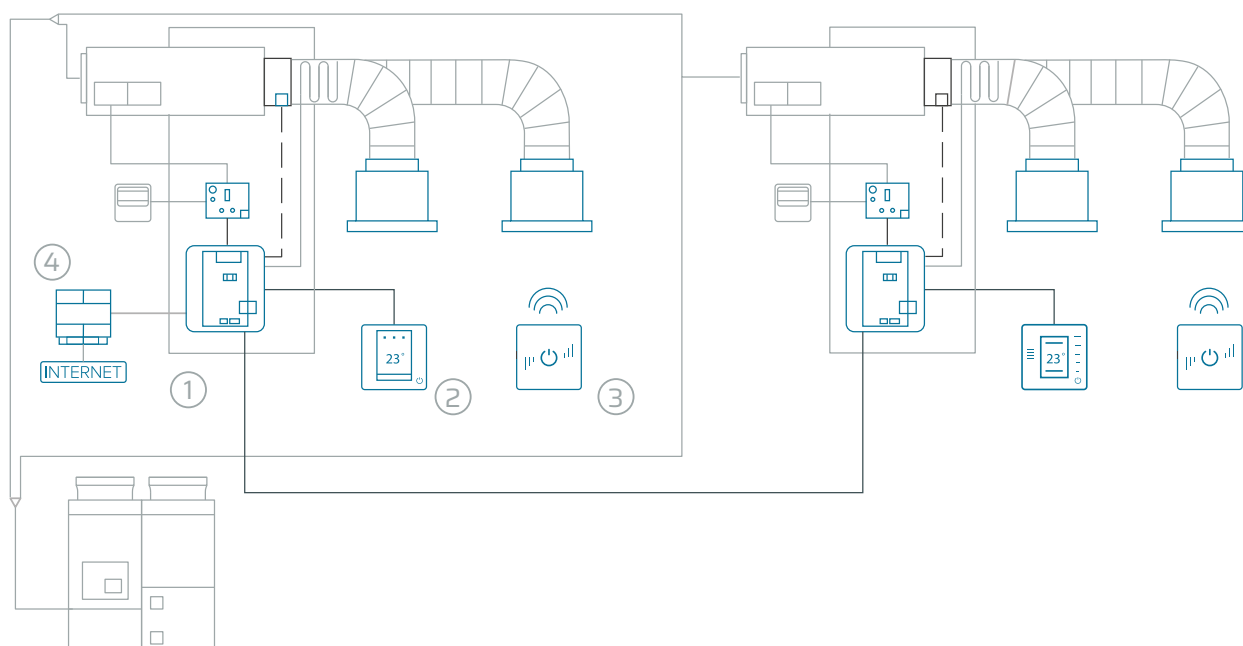

Reference	Description	Qty
1	AZZS6 [XXX] [ST/SL/BS] 4x [200/150] Easyzone [Standard + CMV / Slim + CMV / Medium] IB8 [brand] 4x [200/150] 01M Airzone - [brand] controller gateway Main controller of the Airzone Flexa 3.0 system - Innobus Pro8 - 8 zones Ioniser for each damper and integrated sensor	1
2	AZZS6BLUEFACEC [B/N]	1
3	AZZS6LITER [B/N]	2
4	AZX6WSPHUB	1

- 
 Independent temperatures
- 
 Time schedules*
- 
 Remote management*
- 
 Weather forecasts*
- 
 Commercial buildings and hotels

Easy maintenance

The ducted units placed in the common areas allow access to them without disturbing the occupants of the treated zones and maintenance costs are reduced.

More modularity

In the event of a change in the layout of the offices, the diffusers can be moved easily.

An integrated solution

Compatibility with the main **BMS, home automation and IoT technologies.**

- Airzone Cloud Application.
- Voice assistants Amazon Alexa or Google Assistant.
- Modbus Protocol.
- Local and Cloud API.

* Applicable when the System has an Airzone Cloud Webserver.

Integration of control systems

Connect your HVAC applications to major building management systems with our solutions.

{ REST:API }

Local API



Modbus

Modbus RTU Port

Gateways

We control the following parameters

- The operating mode of the application.
- The fan speed of the indoor unit.
- Domestic hot water (DHW).
- Error detection.
- The data of each zone:
 - > The status of the zone.
 - > The reading of the room temperature and humidity.
 - > The set-point temperature.
 - > The management of the air stage and radiant elements.

Airzone Cloud Webserver HUB

The new Airzone Cloud Webserver HUB module **allows Airzone systems to connect to the Cloud**. Always keep control of your applications, by transforming your devices into control interfaces. Any time, anywhere.



- Control up to 32 Airzone systems.
- Ethernet port.
- RS485 port for BACnet MS/TP, Modbus.
- 2.4 GHz/5 GHz Wi-Fi connectivity.
- Bluetooth Low Energy (BLE) connectivity for configuration.
- Allows configuration as Lutron gateway or BACnet IP.
- Remote update of Webserver firmware and connected systems.
- Remote management of system errors.

BACnet IP and MS/TP

- Plug&Play.
- One Airzone Cloud Webserver HUB as BACnet gateway per system.
- Control up to 32 systems.
- Accessible from Airzone Cloud.
- Ethernet/Wi-Fi connection.



Local API

Direct IP communication with the local web server, Airzone Cloud Webserver HUB.

- Plug&Play.
- Control up to 32 Airzone systems.
- Accessible from Airzone Cloud.
- Ethernet/Wi-Fi connection.

The local API is open to allow the integration of HVAC applications with home automation systems.

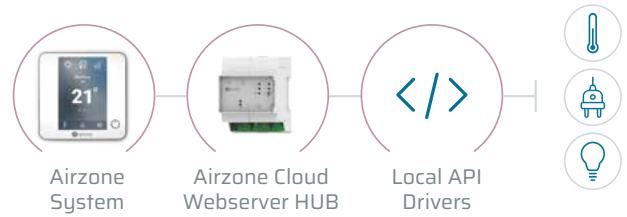

Lutron

- Plug&Play.
- One Airzone Cloud Webserver HUB as Lutron gateway per system.
- Control up to 32 systems.
- Accessible from Airzone Cloud.
- Ethernet/Wi-Fi connection.
- Compatible with Lutron Palladiom thermostats.



Modbus

- Plug&Play.
- One Airzone Cloud Webserver HUB as Modbus gateway per system.
- Control up to 32 systems.
- Accessible from Airzone Cloud.

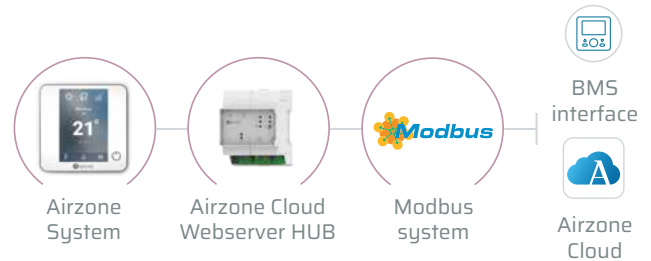

KNX Gateway

- One KNX gateway per Airzone system.
- Control up to 14 zones.
- KNX certified product.
- KNX standard data.
- Configurable from the ETS.
- Compatible with KNX thermostats.



Modbus

Direct control from the home automation port of our main controller. All our products use the Modbus RTU protocol natively.

- Control up to 99 Airzone systems.

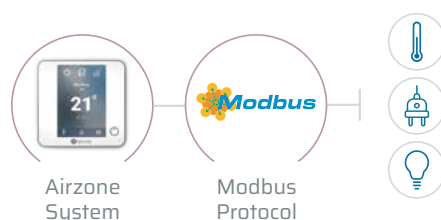

New features 2023/2024

Flexa 4.0 / Easyzone

The new generation of Flexa and Easyzone systems **adds zoned control to underfloor heating/cooling systems and radiators**, allowing joint management of air conditioning and heating from the same zone thermostat. It incorporates Artificial Intelligence in the management of thermal installations in buildings.

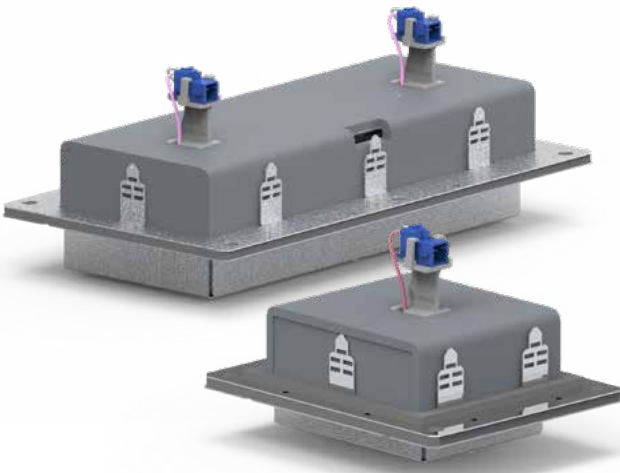
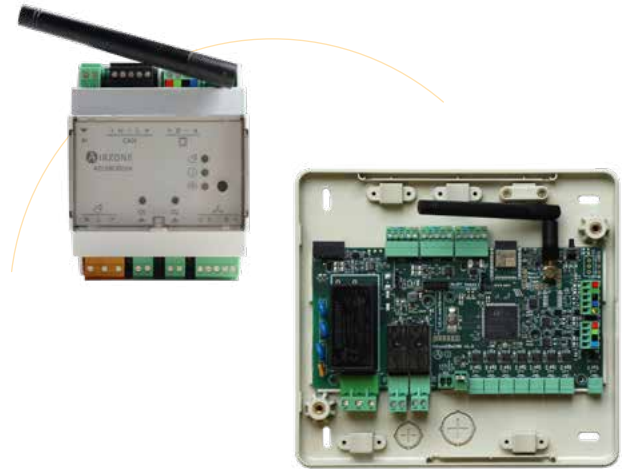

AirQ Box

AirQ Box takes advantage of the air circulation in ducted HVAC applications to **neutralize particles** such as dust, mites, pollen, bacteria and viruses **through the negative ions emitted**.

AirQ Sensor

AirQ Sensor is a device designed to **measure indoor air quality and control elements to improve it**. Depending on the elements installed, AirQ Sensor can activate the ventilation system or the AirQ Box ionization modules.



Aidoo Zigbee

Gateway for **home automation integration of Inverter/VRF units in Zigbee systems.**

Aidoo Zigbee is certified by the Connectivity Standards Alliance allowing interoperability on any Zigbee network according to Alliance standards. As a permanently powered node, it acts as a repeater and improves network reliability.



Aidoo Pro DX with Airzone Blueface thermostat

The Blueface touchscreen thermostat **is now compatible with Aidoo Pro DX.** Aidoo users can now control their device both from the Airzone Cloud app and the wall thermostat.

Aidoo Pro Air To Water

Aidoo Pro Air To Water is a device for the **remote control of air to water units through the Airzone Cloud app.** Thanks to its wide range of integration options, it allows the management of these units from home automation and building management systems (BMS).



Aidoo Pro Air To Water with Aidoo Pro Fancoil

Aidoo Pro Air To Water combined with Aidoo Pro Fancoil makes it possible to manage **installations with an air to water unit as a production element and a fancoil unit as an emission element,** all from the Airzone Cloud app.

This combination of two Aidoo devices, which are easy to install and configure, allows complete control through a simple architecture.



Pricelist Airzone

AirQ + New!!



Remote control



Individual units



Air quality



Pack format

Reference	Description	Price
AZAIQPBWSPFAN [B/N]	Pack AirQ Box - Aidoo Pro Fan coil - Blueface [white/black]	780,00
AZAIQPBWSP [XXX]	Pack AirQ Box - Aidoo Pro [brand]	663,00
AZX6AIQBOXM	AirQ Box in-duct IAQ monitoring and controlling device	475,00
AZX6AIQBOXS	AirQ Box in-duct IAQ controlling expansion module	239,00



Replace **[XXX]** with the corresponding acronym, depending on the brand of the unit:

BA1 = Baxi R32	FU2 = Fujitsu UART	HS1 = Hisense 1x1	LGE = LG	MHI = Mitsubishi Heavy
BAX = Baxi R410A	GR1 = Gree U-Match R32	HS2 = Hisense VRF	MD1= Midea V5	PAN = Panasonic PACi
DA0 = Daikin Residential	GRE = Gree U-Match R410A	HIT = Hitachi RPI	MD2= Midea V6	PA0 = Panasonic RAC
DA1 = Daikin Sky Air/VRV	GR2 = Gree VRF	HI2 = Hitachi RAD	MD4 = MideaV5 (HAHB)	Domestic
FUJ =Fujitsu 3 wires	HAI = Haier	HI3 = Hitachi Primary	MEL = Mitsubishi Electric	SA2= Samsung Nasa
				TOS = Toshiba



AirQ Box M



AirQ Box S



AirQ Box Aidoo Pro Fan coil Blueface



AirQ Box Aidoo Pro Blueface

Aidoo



Remote control



Individual units



Air heating and cooling

Reference	Description	Price
AZAI6WSC [XXX]	Aidoo [brand] Wi-Fi controller Airzone	145,00
AZAI6KNX [XXX]	Aidoo [brand] KNX controller Airzone	145,00
AZAI6WSP [XXX]	Aidoo [brand] Pro controller Airzone	182,00
AZAI6BLUEZEROC [B/N]	Airzone Aidoo wired thermostat - Blueface Zero [white/black]	176,00
AZAI6ZWE [XXX]	Aidoo [brand] Z-Wave controller Airzone	145,00
AZAI6ZBE [XXX] + Coming soon!	Aidoo Zigbee [brand] by Airzone	145,00



Check the availability and compatibility with manufacturers' units at airzonecontrol.com/projects/web-tools

Replace **[XXX]** with the corresponding acronym, depending on the brand of the unit:

BA1 = Baxi R32	FUJ =Fujitsu 3 wires	HS1 = Hisense 1x1	LGE = LG	MHI = Mitsubishi Heavy
BAX = Baxi R410A	FU2 = Fujitsu UART	HS2 = Hisense VRF	MD1= Midea V5	PAN = Panasonic PACi
DA0 = Daikin Residential	GR1 = Gree U-Match R32	HIT = Hitachi RPI	MD2= Midea V6	PA0 = Panasonic RAC
DA1 = Daikin Sky Air/VRV	GRE = Gree U-Match R410A	HI2 = Hitachi RAD	MD4 = MideaV5 (HAHB)	Domestic
DA2 = Daikin Altherma 3	GR2 = Gree VRF	HI3 = Hitachi Primary	MEL = Mitsubishi Electric	SA2= Samsung Nasa
				TOS = Toshiba



Aidoo Wi-Fi



Aidoo KNX



Aidoo Pro



Aidoo Z-Wave



Aidoo Zigbee

All prices are in euros (€) without VAT.

Aidoo Pro Fan coil



Remote control



Individual units



Air heating and cooling



Pack Format

Reference	Description	Price
AZAI6WSPFAN	Aidoo Pro Control Wi-Fi Fan coil Airzone	182,00
AZAI6WSPFANBFC [B/N]	Pack Aidoo Pro Control Wi-Fi Fan coil - wired Blueface [white/black]	295,00
AZAI6WSPFANLTC [B/N]	Pack Aidoo Pro Control Wi-Fi Fan coil - wired Lite [white/black]	256,00
AZAI6BLUEZEROC [B/N]	Airzone Aidoo Pro Fan coil wired thermostat - Blueface Zero [white/black]	176,00



Aidoo Pro Fan coil



Aidoo Pro Fan coil Blueface



Aidoo Pro Fan coil Lite

Check the availability and compatibility with manufacturers' units at

Airzone UNO



Individual AC units



Air heating and cooling



Pack Format

Reference	Description	Price
AZUN6PCMVAHC [B/N]	Pack Airzone UNO damper/valve Think wired [black/white]	262,00
AZUN6PCMVAHR [B/N]	Pack Airzone UNO damper/valve Think wireless [white]	393,00
AZUN6CCMVANAC	Airzone UNO main controller damper/valve for switch	105,00

Check availability and compatibility with manufacturers' units at airzonecontrol.com



Airzone UNO damper/valve



Airzone UNO main controller damper/valve

Flexa 4.0



Zoned control



Underfloor heating



Underfloor heating/cooling



Pack format

This system offers the functions of RadianT365 for underfloor heating and cooling and radiators.



Reference	Description	RRP
Main control board		
AZCE8CB1MOT	Flexa 4.0 main control board with actuator outputs - 8 zones	269.00
AZCE8CB1DIN + New!	Flexa 4.0 main control board using DIN rail - 8 zones	136.00
Control modules		
AZCE8CM1VALC + New!	Airzone Flexa 4.0 control module of 110/230V wired valves - 8 zones	230.00
AZCE8CM1VALR + New!	Airzone wireless VALR valve control module	95.00
AZCE8CM1DRY ³ + New!	Airzone Flexa 4.0 dehumidifier module	99.00
User interfaces		
[B/N]	Airzone Flexa Blueface Zero wired thermostat [black/white]	183.00
AZCE6THINKR [B/N]	Airzone Flexa Think monochrome wireless thermostat [black/white]	186.00
AZCE6LITEC [B/N]	Airzone Flexa Lite simplified wired thermostat [black/white]	114.00
AZCE6LITER [B/N]	Airzone Flexa Lite simplified wireless thermostat [black/white]	143.00
Centralized control		
AZX6WSC5GER	Airzone Cloud Webserver Wi-Fi Dual 2.4-5 GHz	156.00
AZX6WSPHUB	Webserver HUB Airzone Cloud Dual 2.4-5 GHz/Ethernet	187.00
AZX6CCPGAWI	Airzone hydronic production control board	166.00
AZX6KNXGTWAY	Airzone - KNX integration gateway	156.00
Airzone® communication gateway		
AZ6XGTC [XXX] ¹ AZX6QADAPT3 [XXX] ¹	Airzone Controller / Communications gateway - [brand]	205.00
AZX6FANCOILZ	Airzone control gateway - 3 speed fan coil	99.00
AZX6010VOLTSZ	Airzone control gateway - 0-10 V fancoil	187.00
AZX6ELECTROMECH	Airzone control gateway - electromechanical unit	187.00
AZX6GAW [XXX] ²	Airzone air to water gateway - [brand]	205.00
Accessories		
AZX6AC1VALC	Airzone wired 110/230V VALC thermostatic head for radiant elements M30x1.5 mm	36.00
AZX6AC1VALR + New!	Airzone VALR wireless thermostatic head for radiators	49.00
AZCE8ACCOFF	Airzone on/off zone module 8 zones	55.00
AZX6CABLEBUS15	Airzone bus cable (2x0.5+2x0.22) 15 m	15.00
AZX6CABLEBUS100	Airzone bus cable (2x0.5+2x0.22) 100 m	71.00
AZX6CABLEBUS500	Airzone bus cable (2x0.5+2x0.22) 500 m	310.00
AZX6CABLEBUSHF	Airzone halogen-free bus cable (2x0.5 + 2x0.22) 100 m	104.00
AZX6CABLERN100	Airzone RN cable (2x0.22) 100 m	52.00
AZX6CABLERNHF	Airzone halogen-free RN cable (2x0.22) 100 m	98.00
AZX6ACCCON	Airzone consumption meter	104.00
AZX6SONDPROTECT	Airzone temperature metallic probe in sheath	16.00

All prices are in euros (€) without VAT.

Consult availability and compatibility with manufacturers' units at airzonecontrol.com

¹Substitute [xxx] for the acronym according to the unit brand:

BA1 = Baxi R32	FUJ = Fujitsu 3 wires	HI2 = Hitachi RAD	MD2= Midea V6	SA2= Samsung Nasa
BAX = Baxi R410A	GR1 = Gree U-Match R32	HS2 = Hisense VRF HIT =	MD4 = Midea V5 (HAHB)	SAM= Samsung
DA0 = Daikin Residential	GRE = Gree U-Match R410A	Hitachi RPI	MEL = Mitsubishi Electric	TOS = Toshiba
DA1 = Daikin Sky Air/VRV	GR2 = Gree VRF	HI3 = Hitachi Primary	MHI = Mitsubishi Heavy	
DA3 = Daikin Fancoil HPC	HAI = Haier	LGE = LG	PA0 = Panasonic RAC Domestic	
FU2 = Fujitsu UART	HS1 = Hisense 1x1	MD1= Midea V5	PAN = Panasonic PACI	

²Substitute [xxx] for the acronym according to the unit brand:

DA2 = Daikin Altherma 3
HI4 = Hitachi Yutaki
MD3 = Midea M-Thermal
OTH = OpenTherm
ME2 = Mitsubishi Electric Ecodan
PA2 = Panasonic Aquarea <i>Available soon</i>

Consult the compatibility tool:
airzonecontrol.com/eu/en/projects/

³Consult availability.



Main control board



Module of radiant elements VALC (floor)



Module of radiant elements VALR (radiators)



Dehumidifier module



Airzone thermostats



Airzone Cloud Webserver Wi-Fi Dual 2.4-5 GHz



Airzone Cloud Webserver HUB



Hydronic production control board



Integration gateways



3.0 controller gateway



3-speed fancoil gateway



0-10 V fancoil gateway



Electromechanical unit gateway



Air to water gateways



Wired thermostatic head



Wireless thermostatic head



On/Off zone module



Consumption meter



Airzone bus cable



Airzone RN cable



Temperature probe in sheath

All prices are in euros (€) without VAT.

Standard quote · Flexa 4.0

Zoned ducted inverter unit for 4 zones.



Reference	Description	Unit	P/U
AZCE8CB1MOT	Flexa 4.0 main control board - 8 zones	1	269.00
AZX6GTC [XXX]	Airzone - [brand] Controller Gateway	1	205.00
AZCE6BLUEZEROC [B/N]	Airzone Flexa Blueface Zero wired thermostat [black/white]	1	270.00
AZCE6THINKR [B/N]	Airzone Flexa Think monochrome wireless thermostat [black/white]	2	186.00
AZCE6LITEC [B/N]	Airzone Flexa Lite simplified wired thermostat [black/white]	1	114.00
RINTO30015BKMRE	Triple smart grille 300x150 mm white	4	166.00
AZX6WSC5GER	Airzone Cloud Webserver Wi-Fi Dual 2.4-5 GHz	1	156.00
AZX6CABLEBUS100	Airzone bus cable (2x0.5+2x0.22) 100 m	1	71.00
AZX6CABLERN100	Airzone RN cable(2x0.75) 100 m	1	52.00
AZX6ACCCON	Airzone consumption meter	1	104.00
TOTAL			2190.00

Starting up service

Optimize your installation time with our starting up service. Consult Airzone's **starting up service rate** according to the number of systems:

AZST0102	Airzone Technical Support Service for 1 to 2 systems or 1 to 5 Aidoos	207.00
AZST0305	Airzone Technical Support Service for 3 to 5 systems or 6 to 10 Aidoos	332.00
AZST0610	Airzone Technical Support Service for 6 to 10 systems or 11 to 20 Aidoos	549.00
AZST1120	Airzone Technical Support Service for 11 to 20 systems	828.00

Request the starting up service at myzone.airzone.es/citaprevia.

+ More compact packs for radiator control.

Radiator Pack

CONSULT THE NEW PACK REFERENCES.

Example: **AZCE8PVALR3**

Includes: One Airzone Flexa 4.0 main control board using DIN rail, one Webserver HUB Airzone Cloud Dual 2.4-5 GHz/Ethernet, one Airzone wireless VALR valve control module, three Airzone VALR wireless thermostatic heads for radiators and one Airzone bus cable.

Reference	Description	Radiators	Price
AZCE8PVALR2	Airzone VALR pack for radiators with 2 thermostatic heads	2	434.00
AZCE8PVALR3	Airzone VALR pack for radiators with 3 thermostatic heads	3	478.00
AZCE8PVALR4	Airzone VALR pack for radiators with 4 thermostatic heads	4	523.00
AZCE8PVALR5	Airzone VALR pack for radiators with 5 thermostatic heads	5	567.00
AZCE8PVALR6	Airzone VALR pack for radiators with 6 thermostatic heads	6	612.00
AZCE8PVALR7	Airzone VALR pack for radiators with 7 thermostatic heads	7	657.00
AZCE8PVALR8	Airzone VALR pack for radiators with 8 thermostatic heads	8	701.00



Add **one head** for each additional AZX6AC1VALR radiator to the pack.



Possibility of adding a **wired/wireless Blueface, Think radio or Lite thermostat** to the pack.

Starting up service

Optimize your installation time with our starting up service. Consult Airzone's **starting up service rate** according to the number of systems:

AZST0102	Airzone Technical Support Service for 1 to 2 systems or 1 to 5 Aidoos	207.00
AZST0305	Airzone Technical Support Service for 3 to 5 systems or 6 to 10 Aidoos	332.00
AZST0610	Airzone Technical Support Service for 6 to 10 systems or 11 to 20 Aidoos	549.00
AZST1120	Airzone Technical Support Service for 11 to 20 systems	828.00

Request the starting up service at myzone.airzone.es/citaprevia.

Consult the compatibility tool:
airzonecontrol.com/eu/en/projects/

+ More compact packs for underfloor heating and cooling control.

Underfloor Heating and Cooling Pack

CHANGE IN THE REFERENCES AND NEW STARTER PACK.

Example: **AZCE8PVALC3BLRB**

Includes: One Airzone Flexa 4.0 main control board using DIN rail, one Airzone control module of 110/230V VALC wired valves, one white Airzone Blueface Zero wired thermostat, three white wireless Airzone Lite thermostats and one Airzone bus cable.

Reference	Thermostats	Zones	RRP wired	RRP wireless
Starter Pack				
AZCE8PVALCBF [B/N]	1 wired Airzone Blueface	1	428.00	-
Zone Pack				
AZCE8PVALC2BL[C/R][B/N]	1 wired Airzone Blueface 1 [wired/wireless] Airzone Lite	2	542.00	585.00
AZCE8PVALC3BL[C/R][B/N]	1 wired Airzone Blueface 2 [wired/wireless] Airzone Lite	3	631.00	715.00
AZCE8PVALC4BL[C/R][B/N]	1 wired Airzone Blueface 3 [wired/wireless] Airzone Lite	4	719.00	845.00
AZCE8PVALC5BL[C/R][B/N]	1 wired Airzone Blueface 4 [wired/wireless] Airzone Lite	5	821.00	989.00
AZCE8PVALC6BL[C/R][B/N]	1 wired Airzone Blueface 5 [wired/wireless] Airzone Lite	6	900.00	1,111.00
AZCE8PVALC7BL[C/R][B/N]	1 wired Airzone Blueface 6 [wired/wireless] Airzone Lite	7	980.00	1,232.00
AZCE8PVALC8BL[C/R][B/N]	1 wired Airzone Blueface 7 [wired/wireless] Airzone Lite	8	1,059.00	1,354.00



Add as many AZX6AC1VALC wired thermostatic heads to the pack as you need.

Starting up service

Optimize your installation time with our starting up service. Consult Airzone's **starting up service rate** according to the number of systems:

AZST0102	Airzone Technical Support Service for 1 to 2 systems or 1 to 5 Aidoos	207.00
AZST0305	Airzone Technical Support Service for 3 to 5 systems or 6 to 10 Aidoos	332.00
AZST0610	Airzone Technical Support Service for 6 to 10 systems or 11 to 20 Aidoos	549.00
AZST1120	Airzone Technical Support Service for 11 to 20 systems	828.00

Request the starting up service at myzone.airzone.es/citaprevia.

Consult the compatibility tool:
airzonecontrol.com/eu/en/projects/

All prices are in euros (€) without VAT.

Easyzone IAQ · Types of plenum

No. dampers	Dimensions		
	Standard + CMV	Slim + CMV	Medium
2 / 3	930 x 300 x 454	720 x 210 x 444	930 x 250 x 454
4	1,140 x 300 x 454	930 x 210 x 444	1,140 x 250 x 454
5	1,425 x 300 x 454	1,140 x 210 x 444	1,425 x 250 x 454
6	1,638 x 300 x 454	-	1,638 x 250 x 454
7 / 8	1,425 x 515 x 454	-	-

Measurements expressed in: L x H x W (mm).

Check your compatibility and the number of plenum dampers to confirm measurements at airzonecontrol.com

STANDARD · ST + CMV

- Dampers: Ø200 mm
- CMV inlet: Ø 150 mm
- Height: 300 mm



SLIM · SL + CMV

- Dampers: Ø150 mm
- CMV inlet: Ø 150 mm
- Height: 210 mm



MEDIUM · BS

- Dampers: Ø200 mm
- Height: 250 mm



The plenum includes a Flexa main control board, a communication gateway, ionizers and a particle sensor.

Easyzone IAQ



Air quality



Zoned control



Air heating and cooling



Underfloor heating

Reference	No. dampers	Standard + CMV	Medium	Slim + CMV
AZEZ8 [XXX] [ST/SL/BS] [range] [size] [no. dampers]	2	1,058.00	1,058.00	1,058.00
	3	1,073.00	1,073.00	1,073.00
	4	1,320.00	1,320.00	1,320.00
	5	1,339.00	1,339.00	1,339.00
	6	1,354.00	1,354.00	-
	7	1,536.00	-	-
	8	1,719.00	-	-

Reference	Description	RRP
Control modules		
AZCE8CM1VALC + New!	Airzone Flexa 4.0 control module of 110/230V wired valves - 8 zones	230.00
AZCE8CM1VALR + New!	Airzone wireless VALR valve control module	95.00
AZCE8CM1DRY ¹ + New!	Airzone Flexa 4.0 dehumidifier module	99.00
User interfaces		
AZCE6BLUEZEROC [B/N]	Airzone Blueface Zero wired thermostat [black/white]	270.00
AZCE6THINKR [B/N]	Airzone Think monochrome wireless thermostat [black/white]	186.00
AZCE6LITEC [B/N]	Airzone Lite simplified wired thermostat [black/white]	114.00
AZCE6LITER [B/N]	Airzone Lite simplified wireless thermostat [black/white]	143.00
Centralized control		
AZX6WSC5GER	Airzone Cloud Webserver Wi-Fi Dual 2.4-5 GHz	156.00
AZX6WSPHUB	Webserver HUB Airzone Cloud Dual 2.4-5 GHz/Ethernet	187.00
AZX6CCPGAWI	Airzone hydronic production control board	166.00
AZX6KNXGTWAY	Airzone - KNX integration gateway	156.00

All prices are in euros (€) without VAT.

¹Consult availability.



Reference	Description	RRP
Airzone® communication gateway		
AZX6GTC [XXX] ¹	Airzone - [brand] Controller Gateway	205.00
AZX6QADAPT3 [XXX] ²	Airzone communication gateway - [brand]	205.00
AZX6FANCOILZ	Airzone control gateway - 3 speed fan coil	99.00
AZX6010VOLTSZ	Airzone control gateway - 0-10 V fancoil	187.00
AZX6ELECTROMECC	Airzone control gateway - electromechanical unit	187.00
AZX6GAW [XXX] ³	Airzone air to water gateway - [brand]	205.00
Accessories		
AZX6ACTIVALC	Airzone wired 110/230V VALC thermostatic head for radiant elements M30x1.5 mm	36.00
AZX6ACTIVALR	Airzone VALR wireless thermostatic head for radiators	49.00
AZX6CABLEBUS15	Airzone bus cable (2x0.5+2x0.22) 15 m	15.00
AZX6CABLEBUS100	Airzone bus cable (2x0.5+2x0.22) 100 m	71.00
AZX6CABLEBUS500	Airzone bus cable (2x0.5 + 2x0.22) 500 m	310.00
AZX6ACCCON	Airzone consumption meter	104.00
AZX6SONDPROTECT	Airzone temperature metallic probe in sheath	16.00

Consult the Easyzone references configurator at airzonecontrol.com

¹Substitute [xxx] for the acronym according to the unit brand:

BA1 = Baxi R32	FUJ =Fujitsu 3 wires	HIT = Hitachi RPI	MD2= Midea V6	PAN = Panasonic PACi
BAX = Baxi R410A	HAI = Haier	HI3 = Hitachi Primary	MD4 = Midea V5 (HAHB)	SA2= Samsung Nasa
DA1 = Daikin Sky Air/VRV	HS1 = Hisense 1x1	LGE = LG	MHI = Mitsubishi Heavy	TOS = Toshiba
DA3 = Daikin Fancoil HPC	HS2 = Hisense VRF			

²Substitute [xxx] for the acronym according to the unit brand:

DA0 = Daikin Residential	GRE = Gree U-Match R410A	MD1= Midea V5	PA0 = Panasonic RAC Domestic
FU2 = Fujitsu UART	GR2 = Gree VRF	MEL = Mitsubishi Electric	SAM= Samsung
GR1 = Gree U-Match R32	HI2 = Hitachi RAD		

³Substitute [xxx] for the acronym according to the unit brand:

DA2 = Daikin Altherma 3
 HI4 = Hitachi Yutaki
 MD3 = Midea M-Thermal
 OTH = OpenTherm
 ME2 = Mitsubishi Electric Ecodan
 PA2 = Panasonic Aquarea *Available soon*



Air to water gateways



Wired thermostatic head



Wired thermostatic head



3.0 controller gateway



Consumption meter



Temperature probe in sheath



Module of radiant elements



Airzone thermostats



Airzone Cloud Webserver Wi-Fi Dual 2.4-5 GHz



Airzone Cloud Webserver HUB



Airzone bus cable

Consult the compatibility tool:
airzonecontrol.com/ib/es/projectos

All prices are in euros (€) without VAT.

Standard quote · Easyzone IAQ

Flexible ducted inverter unit for 4 zones.



Reference	Description	Unit	P/U
AZEZ8 [XXX] ST01M4	Easyzone IAQ Standard + CMV IB8 [brand] x200 01 M 4	1	1,320.00
AZCE6BLUEZEROC [B/N]	Airzone Blueface Zero wired thermostat [black/white]	1	270,00
AZCE6THINKR [B/N]	Airzone Think monochrome wireless thermostat [black/white]	2	186.00
AZCE6LITER [B/N]	Airzone Lite simplified wireless thermostat [black/white]	1	143.00
PREJ030015T	Plenum for grilles with connection to insulated circular duct	4	59.00
RDHV030015BKK	Horizontal-vertical double deflection supply grille	4	20.00
AZX6WSC5GER	Airzone Cloud Webserver Wi-Fi Dual 2.4-5 GHz	1	156.00
AZX6CABLEBUS15	Airzone bus cable (2x0.5+2x0.22) 15 m	1	15.00
AZX6ACCCON	Airzone consumption meter	1	104.00
TOTAL			2,609.00

Starting up service

Optimize your installation time with our starting up service. Consult Airzone's **starting up service rate** according to the number of systems:

AZST0102	Airzone Technical Support Service for 1 to 2 systems or 1 to 5 Aidoos	207.00
AZST0305	Airzone Technical Support Service for 3 to 5 systems or 6 to 10 Aidoos	332.00
AZST0610	Airzone Technical Support Service for 6 to 10 systems or 11 to 20 Aidoos	549.00
AZST1120	Airzone Technical Support Service for 11 to 20 systems	828.00

Request the starting up service at myzone.airzone.es/citaprevia.

Acuazone



Zoned control



Individual units



Air heating and cooling



Radiant heating / cooling



Reference	Description	Price
Main controller of the system		
AZDI6ACUAZONE	Airzone Acuazone main control board - 32 zones	371,00
Control modules		
AZDI6OUTPUT8	Airzone control module of radiant elements - 32 zones	253,00
User interfaces		
AZDI6BLUEZEROC [B/N] ¹	Airzone Acuazone Blueface Zero wired thermostat [white/black]	253,00
AZDI6THINKR [B/N]	Airzone Acuazone Think wireless monochrome thermostat [white/black]	275,00
AZDI6LITEC [B/N]	Airzone Acuazone Lite Thermostat wired [white/black]	186,00
AZDI6LITER [B/N]	Airzone Acuazone Lite Thermostat wireless [white/black]	232,00
Local modules		
AZDI6ZMO [XXX] ² C	Airzone [brand] individual unit module wired for gateway	229,00
AZDI6ZMO [XXX] ² R	Airzone [brand] individual unit module wireless for gateway	268,00
AZDI6MCIFRC	Airzone infrared individual unit zone module wired	202,00
AZDI6MCIFRR	Airzone infrared individual unit zone module wireless	253,00
AZDI6ZMOFANR	Fan coil individual unit zone module wireless	229,00
AZDI6ZMOFANC	Fan coil individual unit zone module wired	191,00
AZDI6MCFANC	Airzone 3 speed fan coil individual unit zone module wired	122,00
AZDI6MCFANR	Airzone 3 speed fan coil individual unit zone module wireless	160,00
AZDI6MZZONC	Airzone Acuazone local module wired	71,00
AZDI6MZZONR	Airzone Acuazone local module wireless	96,00
AZDI6MZSREC	Airzone electrical heating zone module wired	71,00
AZDI6MZSRER	Airzone electrical heating zone module wireless	96,00

Check the availability and compatibility with manufacturers' units at airzonecontrol.com/projects/web-tools

¹ One Blueface thermostat per main controller of the Acuazone system is necessary.

² Replace [XXX] with the corresponding acronym, depending on the brand of the unit:

BA1 = Baxi R32

BAX = Baxi R410A

DA0 = Daikin Residential

DA1 = Daikin Sky Air/VRV

DA3 = Daikin Fan coil

HPC FUJ = Fujitsu 3 wires

FU2 = Fujitsu UART

GR1 = Gree U-Match R32

GRE = Gree U-Match R410A

GR2 = Gree VRF

HAI = Haier

HS1 = Hisense 1x1

HS2 = Hisense VRF

HIT = Hitachi RPI

HI2 = Hitachi RAD

HI3 = Hitachi Primary

LGE = LG

MD1 = Midea V5

MD2 = Midea V6

MD4 = Midea V5 (HAHB)

MEL = Mitsubishi Electric

MHI = Mitsubishi Heavy

PAN = Panasonic PACi

PA0 = Panasonic RAC

Domestic

SAM = Samsung

SA2 = Samsung Nasa

TOS = Toshiba



Main controller of the system



Radiant element module



Airzone Thermostats



Local module individual unit



Local module for individual Fan coil unit



Local module for infrared individual unit



Local module 3-speed individual Fan coil unit



Local module for electric heating



Local module for motor

All prices are in euros (€) without VAT.

Reference	Description	Price
Centralised control		
AZX6WSC5GER	Webserver Airzone Cloud Wi-Fi Dual 2.4-5 GHz	253,00
AZX6WSPHUB	Webserver HUB Airzone Cloud Dual 2,4-5 GHz/Ethernet	304,00
AZX ⁶ CCPGAWI	Airzone hydraulic production control board	270,00
AZX6KNXGTWAY	Integration gateway Airzone-KNX	253,00
Airzone® communication gateway		
AZX6GTC [XXX] ¹	Airzone - [brand] controller gateway	304,00
AZX6QADAPT3 [XXX] ²	Airzone communication gateway - [brand]	304,00
AZX6FANCOILZ	Airzone control gateway for 3-speed radiant Fan coil	161,00
AZX6010VOLTSZ	Airzone 0-10V fan coil control gateway	253,00
AZX6ELECTROMECH	Airzone control gateway for electromechanical unit	304,00
AZX6GAW [XXX] ³	Airzone - [brand] air to water hp gateway	304,00

Check the availability and compatibility with manufacturers' units at airzonecontrol.com/projects/web-tools

¹ Replace [XXX] with the corresponding acronym, depending on the brand of the unit:

BA1 = Baxi R32	FUJ = Fujitsu 3 wires	HIT = Hitachi RPI
BAX = Baxi R410A	HAI = Haier	HI3 = Hitachi Primary
DA1 = Daikin Sky Air/VRV	HS1 = Hisense 1x1	LGE = LG
DA3 = Daikin Fancoil HPC	HS2 = Hisense VRF	

² Replace [XXX] with the corresponding acronym, depending on the brand of the unit:

DA0 = Daikin Residential	GRE = Gree U-Match R410A	MD1 = Midea V5
FU2 = Fujitsu UART	GR2 = Gree VRF	MEL = Mitsubishi Electric
GR1 = Gree U-Match R32	HI2 = Hitachi RAD	

³ Replace [XXX] with the corresponding acronym, depending on the brand of the unit:

DA2 = Daikin Altherma 3
 HI4 = Hitachi Yutaki
 MD3 = Midea M-Thermal
 OTH = OpenTherm
 ME2 = Mitsubishi Electric Ecodan
 PA2 = Panasonic Aquarea *Coming soon*



Airzone Cloud
Webserver



Airzone Cloud
Webserver HUB



Main controller for hydraulic
production



Integration gateways



Controller gateway 3.0



Gateway for 3-speed
Fan coil unit



Gateway for
Fan coil 0-10 V unit



Gateway for
electromechanical unit



Air-to-Water heat pump
gateways



Reference	Description	Price
Accessories		
AZX6ACIVALC	Airzone wired thermostatic valve actuator 110/230V VALC for radiant elements M30x1.5 mm	42,00
AZX6CABLEBUS15	Airzone bus wire (2x0,5+2x0,22) 15 m	24,00
AZX6CABLEBUS100	Airzone bus wire (2x0,5+2x0,22) 100 m	115,00
AZX6CABLEBUS500	Airzone bus wire (2x0,5+2x0,22) 500 m	504,00
AZX6CABLEBUSHF	Airzone halogen-free bus wire (2x0,5+2x0,22) 100 m	169,00
AZX6CABLERN100	Airzone RN wire (2x0.75) 100 m	84,00
AZX6CABLERNHF	Airzone halogen-free RN wire (2x0.75) 100 m	159,00
AZX6SONDPROTECT	Airzone temperature metallic probe in sheath	26,00
AZX6ACCTPE	Built-in temperature sensor	76,00
AZX6POWER	Airzone 12V power supply unit	84,00



Wired electrothermal motor



Airzone bus cable



Airzone RN Cable



Metal tip temperature sensor



Temperature sensor

All prices are in euros (€) without VAT.

Motorised Air diffusion

Motorised dampers



Motorised circular duct damper

Motorised circular CPCC duct damper which, attached to a circular duct, controls the passage of air in the zone served. The circular duct damper includes a flow control system that allows manual configuration of the maximum and minimum opening values of each damper, according to the needs of each application.

CPCC [LENGTH] [HEIGHT] MTE



Motorized rectangular duct damper

CPRC motorized rectangular duct damper to control the air inlet of the zone when attached to an air distribution rectangular duct.

CPRC [DIAMETER] MTE

Air diffusion

Grilles



Horizontal-vertical double deflection fan grille

RDHV diffusion grille in extruded aluminium with standard 26 mm frame and horizontal and vertical movable blades, individually adjustable, which allows the range and airflow to be adapted to specific needs. The following options are available:

- All/Nothing: the damper occupies 100% of the grille.
- Minimum air: the damper occupies 80% of the grille.
- 2 in 1: the damper occupies 50% of the grille.

RDHV



Return grille with filter holder

RRFR diffusion grille in extruded aluminium with standard 26 mm frame and horizontal movable blades, individually adjustable, which allows the range and airflow to be adapted to specific needs.

Fitted with a filter to protect and prevent air intake with a high concentration of suspended particles and other foreign bodies.

RRFR

Grilles



15° Fixed linear blade grille

Diffusion grille in extruded aluminium with standard 26mm frame and blades that promote airflow. The following options are available:

- All/Nothing: the damper occupies 100% of the grille.
- Minimum air: the damper occupies 80% of the grille.
- 2 in 1: the damper occupies 50% of the grille.

RLQ1/RLQ2/RLQV

Linear diffusers



Airzone linear diffuser

Long-range DFLI linear diffuser with 1 to 4 outlet slots, which promotes air blowing in two directions with the help of movable blades. Designed to be installed on a ceiling. Installation using a mounting bridge or a plenum. It is necessary to have the PLEN linear diffuser plenum.

DFLI

Diffuser plenums



Grilles plenum with circular duct connection

Plenum for PREJ diffusion grilles made of galvanised steel, with mechanical flow control. Circular/elliptical connection for circular duct adaptable to front or top opening. PREJ-Ts have type 25 Bs1d0 + 5 mm thick PS Alu insulation. Compatible with the family of diffusion grilles without motorisation and without adjustment elements.

PREJ-T



Insulated mixing box

Designed to collect return air and/or air from the by-pass and reintroduce it into the intake of the indoor unit. The device is supplied with pre-cut outlets (5 elliptical and 2 circular) and 3 elliptical openings, to be mounted on the front or on the sides. The filter holder return grille (RRFR) can only be mounted on BR 400 or 500 plenums.

BR

Postage Policy

Postage paid From	Economy			Express					
	Half Boxes	XS (Extra small)	S (Small)	M (Medium)	L (Large)	XL (Extra large)	XXL (Double extra large)	XXXL (Triple extra large)	
	Medium Price	Box 16x12x6	Box 20x20x12	Box 30x30x28	Box 74x52x27,5	Box 130x40x50	Box 90x80x50	Box 157x53x53	
Maximum 1,000 kg	0.001152	0.0048	0.0252	0.0986	0.2310	0.2959	0.4438		

Spain

Malaga	450.00	10.00	3.00	5.00	11.00	25.00	60.00	88.00	135.00
South	450.00	15.00	5.00	8.00	12.00	25.00	60.00	88.00	140.00
Center	450.00	20.00	7.00	10.00	14.00	25.00	70.00	90.00	140.00
North	450.00	23.00	8.00	12.00	14.00	25.00	70.00	90.00	140.00
Ceuta and melilla	600.00	80.00	20.00	28.00	53.00	95.00	To be quoted	To be quoted	To be quoted
Balearics	500.00	20.00	10.00	20.00	30.00	45.00	80.00	90.00	140.00
Canary Islands	500.00	70.00	20.00	40.00	65.00	140.00	315.00	370.00	550.00

Europe

Germany	900.00	75.00	20.00	28.00	53.00	113.00	205.00	243.00	293.00
Albanian	Due	160.00	30.00	60.00	95.00	175.00	295.00	235.00	465.00
Andorra	700.00	73.00	18.00	26.00	48.00	93.00	165.00	213.00	285.00
Austria	900.00	85.00	20.00	28.00	53.00	113.00	205.00	243.00	305.00
Belgium	600.00	70.00	20.00	28.00	53.00	105.00	205.00	243.00	285.00
Bosnian & Herzegovina	Due	130.00	30.00	55.00	100.00	190.00	325.00	365.00	455.00
Bulgaria	1,000.00	100.00	25.00	45.00	80.00	135.00	255.00	283.00	355.00
Cyprus	Due	130.00	25.00	45.00	78.00	135.00	255.00	285.00	355.00
Croatia	1,000.00	95.00	25.00	45.00	78.00	135.00	255.00	283.00	355.00
Denmark	1,500.00	95.00	25.00	40.00	75.00	135.00	255.00	305.00	355.00
Slovakia	1,000.00	85.00	25.00	45.00	78.00	135.00	255.00	305.00	355.00
Slovenia	1,000.00	85.00	25.00	45.00	78.00	135.00	255.00	305.00	355.00
Estonia	1,000.00	95.00	25.00	45.00	78.00	135.00	255.00	305.00	355.00
Finland	1,500.00	105.00	25.00	40.00	75.00	135.00	255.00	305.00	355.00
France	600.00	75.00	18.00	25.00	45.00	105.00	200.00	250.00	310.00
Gibraltar	1,000.00	95.00	20.00	27.00	53.00	93.00	255.00	283.00	305.00
Greece	1,000.00	95.00	25.00	40.00	73.00	135.00	255.00	305.00	355.00
Netherlands	900.00	65.00	20.00	28.00	53.00	98.00	185.00	225.00	270.00
Hungary	1,000.00	85.00	25.00	45.00	78.00	135.00	255.00	305.00	355.00
Ireland	1,000.00	95.00	25.00	43.00	78.00	135.00	255.00	305.00	355.00
Italy	800.00	85.00	20.00	30.00	55.00	95.00	145.00	190.00	260.00
Latvia	Due	95.00	25.00	45.00	80.00	135.00	255.00	305.00	355.00
Lithuania	Due	95.00	25.00	45.00	80.00	135.00	255.00	305.00	355.00
Liechtenstein	Due	130.00	30.00	50.00	78.00	135.00	255.00	305.00	355.00

All prices are in euros (€) without VAT.

Luxembourg	900.00	65.00	20.00	27.00	48.00	95.00	185.00	225.00	265.00
Macedonia	Due	110.00	30.00	55.00	98.00	185.00	355.00	405.00	455.00
Europe									
Malt	1,000.00	95.00	25.00	38.00	78.00	135.00	255.00	305.00	365.00
Monaco	1,500.00	130.00	25.00	38.00	78.00	145.00	265.00	305.00	385.00
Montenegro	Due	160.00	30.00	50.00	95.00	185.00	285.00	305.00	455.00
Norway	1,500.00	145.00	30.00	50.00	95.00	180.00	355.00	405.00	455.00
Poland	1,000.00	85.00	25.00	38.00	78.00	138.00	253.00	285.00	355.00
Portugal	500.00	40.00	18.00	23.00	48.00	83.00	163.00	185.00	225.00
United Kingdom	1,000.00	95.00	20.00	33.00	58.00	115.00	215.00	245.00	305.00
Czech Republic	1,000.00	85.00	25.00	38.00	78.00	135.00	255.00	305.00	385.00
Romania	1,000.00	95.00	25.00	38.00	78.00	135.00	255.00	305.00	385.00
San Marino	1,500.00	140.00	25.00	43.00	78.00	145.00	265.00	325.00	395.00
Serbian	Due	100.00	30.00	55.00	98.00	187.00	355.00	405.00	455.00
Sweden	1,500.00	115.00	25.00	40.00	80.00	135.00	255.00	305.00	365.00
Swiss	800.00	115.00	30.00	48.00	95.00	178.00	355.00	405.00	455.00
Vatican	Due	130.00	25.00	38.00	78.00	125.00	255.00	305.00	405.00
Rest of the world									
USA	1,000.00	100.00	25.00	45.00	85.00	125.00	200.00	260.00	360.00
Canada	1,500.00	150.00	30.00	55.00	110.00	155.00	290.00	300.00	430.00
Australia	Due	To be quoted	45.00	65.00	155.00	250.00	400.00	460.00	580.00
New Zealand	Due	To be quoted	45.00	65.00	155.00	250.00	400.00	460.00	580.00
Mexico	Due	To be quoted	40.00	60.00	120.00	190.00	310.00	350.00	470.00
Morocco	10,000.00	To be quoted	30.00	50.00	95.00	160.00	280.00	350.00	420.00
Tunisia	10,000.00	To be quoted	35.00	70.00	100.00	190.00	300.00	360.00	530.00
Turkey	Due	To be quoted	35.00	70.00	100.00	190.00	300.00	360.00	550.00
China	Due	To be quoted	35.00	60.00	120.00	230.00	380.00	400.00	510.00
Hong Kong	Due	To be quoted	35.00	60.00	120.00	230.00	380.00	400.00	530.00
United Arab Emirates	Due	To be quoted	30.00	70.00	100.00	190.00	300.00	360.00	520.00
Qatar	Due	To be quoted	35.00	60.00	130.00	230.00	380.00	400.00	530.00
Saudi Arabia	Due	To be quoted	30.00	70.00	100.00	200.00	300.00	360.00	520.00

Freight Paid From, Exceptions:

Italy: Except for the municipalities of Livigno and Campione d'Italia, as well as the national waters of Lake Lugano between the shore and the political border of the area between Ponte Tresa and Porto Ceresio.

Germany: Except the island of Helgoland and the territory of Büsingen.

France: Except New Caledonia, Saint Pierre and Miquelon, Wallis and Futuna, French Polynesia, and French Southern and Antarctic Territories, but including the overseas departments of Guadeloupe, French Guiana, Martinique, Mayotte, and the Reunion Islands.

Zones of Spain:

Malaga: Province of Malaga

South: Andalusia (except Malaga)

Center: Castilla la Mancha, Madrid, Extremadura, Murcia, Valencian Community.

North: Castilla y León, Aragon, Catalonia, Galicia, Asturias, Basque Country, La Rioja and Cantabria.

Ceuta and Melilla: Ceuta and Melilla

Balearic Islands: Balearic Islands

Canaries: Canary Islands

General Terms and Conditions of Sale

These General Terms and Conditions of Sale (hereinafter the "GTC") apply to any contract of sale and/or provision of services between CORPORACION EMPRESARIAL ALTRA, S.L., a Spanish Company, with Tax ID B92611102 and VAT EU number ESB92611102, (hereinafter Altra Corporation or the "Seller") and professional customers (hereinafter individually the "Customer(s)" or the "Buyer(s)").

The Customer declares to be a professional acting in the context of their activity and not an end user.

Unless otherwise agreed in writing, when an order is sent by the customer, this implies their adherence to these GTC and this, notwithstanding any contrary condition set by the Customer which will be, in the absence of express acceptance, unenforceable against Altra Corporation regardless of when it may have been brought to their attention. It is only after written acceptance of the order by Altra Corporation accompanied by these GTC that both parties are bound by the sales contract.

Any order placed by the Customer in accordance with the conditions provided for in the article "Orders" below, implies its unreserved acceptance of these GTC.

The information on catalogues and commercial proposals is given for information purposes only, Altra Corporation reserves the right to modify them at any time and without notice.

Any modification of the GTC must be the subject of an express written agreement of Altra Corporation. The Customer will thus not be able to rely on an alleged tacit agreement resulting from the silence of Altra Corporation.

Orders

All orders must reach us at the address orders@airzonecontrol.com or via the www.airzonecontrol.com platform. During each order, the Seller sends by e-mail and as soon as possible, an order acknowledgment indicating: the summary of the order, the prices and the expected date of exit from our factory stock. To place the order, the Buyer must create a customer account by following the instructions on the Altra Corporation website www.airzonecontrol.com. The Buyer is obliged to report any errors or omissions in the order acknowledgement within 24 hours of the reception of the order confirmation. After this period, no dispute can be accepted, and the order will be considered accepted by the Seller and the Buyer and therefore final. The Buyer has the right to cancel his order within a maximum of 24 hours after receipt of the order acknowledgment by an email request to the address: orders@airzonecontrol.com. Orders are likely to be delivered in split shipments, depending on the characteristics of the order or at the request of the Customer, for a transport surcharge for any request for early delivery. When the selection of the proposed material is made by

Altra Corporation based on the information provided by the Buyer, Altra Corporation assumes no responsibility that may result from inaccurate or incomplete data. It is always the Buyer's responsibility to ensure that the characteristics of the proposed equipment correspond to its needs, both in terms of performance and of implementation possibilities.

The sale will be made at Buyer's own risk. The photos presented in our catalogues are not contractual.

Price

The prices invoiced to the Customer are prices excluding taxes, denominated in Euros, packaging included, transport costs being invoiced in addition and are established based on the rate in force on the date of the order.

The rates in force are those appearing on the quote of Altra Corporation or any other medium used by Altra Corporation, provided that appears on the said medium a date of validity of the prices. In principle any quote is valid for a maximum period of fifteen (15) days. However, Altra Corporation reserves the right to modify its prices at any time.

In the event of a change in prices after the quote, and more generally if the prices appearing on the quote do not comply with the prices in force, Altra Corporation will inform the Customer, being reminded that the contract cannot be formed and bind Altra Corporation as long as it has not accepted the order by means of the acknowledgment of the order. The Customer must then send a new corrected order. However, Altra Corporation undertakes to invoice the equipment ordered at the prices indicated at the time of the Customer's order acknowledgement.

Retention of title

The products sold remain the entire property of Altra Corporation until their complete and final payment. In the event that the products purchased by the customer are resold, and as long as they have not been paid to Altra Corporation, the customer undertakes to inform the sub-purchaser of the terms of this clause, as well as the right that Altra Corporation reserves to claim in the hands of the sub-purchaser, either the book products or the price thereof.

Receipt of goods

The equipment is sent at the Customer's own risk. Any claim in connection with the loss or imperfections related to the packaging of the products must be made to the transport agency upon receipt of the goods and must be annotated on the carrier's receipt. In this case, the Customer has twenty-four (24) hours to obtain a claim number from the transport agency. The returned material may be accepted subject to verification of the condition of the material and its packaging, as well as its operation. In case of damage to the delivered goods and in order to provide sufficient evidence, the Buyer is obliged to photograph the packages and send the photos to logistics@airzonecontrol.com in order to notify of the problem. Upon receipt of the material, the Customer has fifteen (15) days to inspect the contents and report possible packaging errors or defects in the items. After this period, no such claim will be accepted.

Payment method

No discount is granted in case of early settlement. Payment will be made by bank transfer. In the event of late payment, the applicable penalties shall be equal to 8% of the total invoice with a minimum of 40 € (or its equivalent in the official exchange rate of the currency used in the relevant market). In case of non-payment, Altra Corporation reserves the right to block the account as well as shipments in progress, whether or not they are under warranty.

The goods remain the property of the Seller until full payment.

Likewise, in the event of delay in payment in accordance with the initially agreed deadline, Altra Corporation reserves the right to initiate the necessary legal procedures to obtain collection of the total invoice plus the corresponding penalties for the delay.

Altra Corporation sends invoices by e-mail. Nevertheless, and always at customer's request previously, Altra Corporation could send invoices in paper version.

Commissioning

Altra Corporation does not carry out the installation of its products. However, as indicated in our catalog (see "Commissioning service" in the "Product references" section), the Buyer may call on Altra Corporation for the commissioning of its systems. Altra Corporation will invoice this service carried out by its technical assistance or by one of its technical stations according to the prices in the quotation provided to the Buyer and according to the conditions that can be requested at the email address:

techsupport@airzonecontrol.com

Return

Subject to the agreement of Altra Corporation's technical support, the customer has fourteen (14) days from the date of invoice to return the material and obtain a refund, less 20% re-stocking fee of the original invoice price. It must be taking into consideration that the products must be returned in its original unused packaging. The request should be made via the support department's e-mail address: techsupport@airzonecontrol.com. The Customer assumes the cost of transport and ensures the proper packaging of the equipment guaranteeing its good condition upon receipt. The agreement of the sales department does not directly imply the edition of credit. Any return that does not benefit from a prior agreement will be systematically refused upon receipt and will be returned to the sender at their expense. The returned material will only be refunded if the conditions indicated on the material return request are respected.

The transport costs caused by the return of after-sales equipment in non-EU countries will be borne by the buyer.

Guarantee

All products manufactured by Altra Corporation are warranted, for a period of two (2) years, against any manufacturing defect, the date of issue of the invoice of Altra Corporation being authentic, in the context of normal use. The warranty only applies if the installation of the solution is carried out exclusively with Altra Corporation reference elements, both mechanical and electronic (central plates, modules, thermostats, motorizations, and cables). If the required configuration is not explained in any Altra Corporation manual, the Customer is required to contact Altra Corporation technical support to validate the said configuration. However, in the absence of a written reservation from the Customer upon completion of Altra Corporation's technical assistance service, it is understood that Altra Corporation does not provide any guarantee as to the services provided and that any claim not in accordance with this article will be inadmissible.

Packaging

All our electronic products are individually packaged. It is important, in case of return to our premises, that the material is returned in its original packaging.

Hardware under warranty

All products are covered by a thirty-month warranty from shipment or twenty-four months from installation, whichever comes first.

The warranty does not cover damage caused by misuse or normal wear and tear, or defects caused by negligence, knocks, improper use or handling, storage in inadequate conditions that may damage the product, such as extreme temperatures or humidity, unsuitable voltage, electrical incidents, improper installation and/or use that was not carried out by the authorized Technical Service when appropriate, nor materials subject to wear and tear through normal use. The warranty will be void for any products modified or repaired by the Client or any other person not authorized by Altra Corporation.

Repair or replacement of defective products will be free of charge, including the costs incurred to remedy the goods' lack of conformity with the contract, especially the shipping costs, as well as costs related to manual labor and materials. Any finding of malfunction of the Altra Corporation system must be diagnosed by Altra Corporation technical assistance. For further information regarding the warranty procedure, please contact: techsupport@airzonecontrol.com

Force majeure

Neither party shall be liable to the other in the event of delay or non-performance of its contractual obligations in the event of force majeure in the following cases: natural disasters, fires, explosions, or accidents for which it is not responsible, strike movements, epidemics or pandemics recognized by the World Health Organization, or for other reasons beyond its control.

In the event of a case of force majeure, Altra Corporation may temporarily suspend the delivery of the products and/or the performance of the service, without this suspension being considered as a non-performance of the obligations incumbent on it under these GTC. Altra Corporation must then inform the Customer in writing of the suspension of the contract, and if it lasts more than three (3) months, the suspended sales or service contract(s) will be terminated automatically.

Data protection and intellectual property

The Client is invited to consult the website of Altra Corporation: www.airzonecontrol.com and in the footer the client can access the sections of legal notice, privacy policy and cookies policy.

It is strictly forbidden to use and exploit the rights of reproduction, distribution, public communication, and transformation according to Spanish Regulation in force at the time, as well as to use the Altra Corporation logo or any photographs and information of the products of the said entity, without its prior authorisation.

Dispute Resolution

These GTC and any contract concluded pursuant to these GTC are subject to Spanish law.

The parties are subject to Spanish law for the resolution of any conflict that may arise, and expressly waiving any other jurisdiction, the parties are subject to the courts and tribunals of Madrid (Spain).



Designed and manufactured
in Europe

HQ Andalusia Technology Park
Marie Curie, 21 · 29590 Málaga (Spain)

airzonecontrol.com · +34 900 400 445
projects@airzonecontrol.com

