



# SOLDADURA WELDING 2015/1



 **SOLTER**



SOLDADURA  
PROTECCION Y  
CARGADORES  
DE BATERIA

WELDING,  
PROTECTION  
AND BATTERY  
CHARGERS



Todos los equipos SOLTER  
actualmente en el mercado cumplen  
estrictamente las especificaciones  
de la **UNIÓN EUROPEA**

All SOLTER equipment are  
compliant with **EUROPEAN UNION**  
standards



SOLTER está certificada bajo la  
norma de calidad **ISO 9001**  
SOLTER is certified under the  
**ISO 9001** quality standards



**SOLTER SOLDADURA S.L.** ha demostrado durante los últimos años capacidad de liderazgo mediante la evolución constante de sus productos y servicios. Una vez más, el catálogo **SOLTER** viene repleto de novedades permitiéndonos continuar ofreciendo una solución global dentro de las familias **SOLDADURA, PROTECCIÓN y CARGADORES DE BATERÍA.**

Nuestro departamento de desarrollo y nuestra planta de producción de circuitos electrónicos en Campdevàdol (Girona), nos permiten controlar no solo el diseño y ensamblaje de nuestros productos, sino también asegurar la fiabilidad, calidad global y perfecto funcionamiento de nuestros equipos.

Servicios asociados a nuestra oferta, como el exclusivo programa de formación a clientes o un servicio post-venta ágil e individualizado, no hacen mas que destacar **SOLTER** como una referencia indiscutible.

Son ya más 30 países de los 5 continentes donde desarrollamos nuestra actividad, con cada vez más clientes y colaboradores satisfechos por la calidad y prestaciones de nuestros productos. Sea parte de nuestro proyecto.

**SOLTER WELDING S.L.** has shown leadership through the constant evolution of its products and services for many years. Once more, the catalog **SOLTER** comes packed with new features allowing us to continue offering a global solution within the sectors of **WELDING, PROTECTION and BATTERY CHARGERS.**

Our Development Department and our production plant of electronic circuits in Campdevàdol (Girona), allow us to control not only the design and assembly of our products, but also to ensure the reliability, global quality and perfect functioning of our equipment.

Services associated with our offer, such as the exclusive training program for customers or a flexible and individualized after-sales service simply emphasize **SOLTER** as an undisputed reference.

There are already more than 30 countries on 5 continents where we develop our activity, with increasingly more customers and collaborators satisfied with the quality and Duty Cycle of our products. Become part of our project.

# ÍNDICE PRODUCTOS

PRODUCT INDEX

## MMA

MMA	Mod.	P.
	INVERTER TAPP	10-11
	INVERTER COTT	12-13
	INVERTER COTT SD	14-15
	INVERTER SYL / PRO	16-17
	INVERTER ICON	18-19
	INVERTER ICON PRO	20-21
	AERO ARC 320	22
	AEROPROCESS 4000	23
	RECTIFICADORES SC / RECTIFIERS SC	24
	TRANSFORMADORES SB / TRANSFORMERS SB	25

## TIG

TIG	Mod.	P.
	INVERTER ICON TIG	28-29
	INVERTER ICON TIG PRO	30-31
	AEROTIG DC	32-33
	AEROTIG AC/DC	34-35

## MIG MAG

MIG MAG	Mod.	P.
	SOLMIG	38-39
	AEROPROCESS	40-41
	AEROPROCESS 4200	42-43

## PLASMA

PLASMA	Mod.	P.
	ANTORCHA PLASMA PT 60	45
	SOLCUT 40	46
	SOLCUT 60	47

## ACCESORIOS/ACCESSORIES

ACCESORIOS / ACCESSORIES	Mod.	P.
	ANTORCHAS MIG SX / TORCHES MIG SX	48-49
	ACCESORIOS MATERIAL APORTE/ FILLER MATERIAL ACCESSORIES	50-51
	ANTORCHAS TIG / TORCHES TIG	52-53
	ELECTRODOS / ELECTRODES	54
	PINZAS / CLAMPS	55
	CONECTORES / CONNECTORS	56
	CONJUNTOS DE SOLDADURA COMPLETOS / COMPLETED WELDING KITS	57
	INVERKONTROL DI 230 / INVERKONTROL DI 230	58
	ELECTRODOS / ELECTRODES	59

## PROTECCIÓN/PROTECTION

PROTECTION / PROTECTION	Mod.	P.
	OPTIMATIC	62-63
	FOX PRO	64-65
	OPTIMATIC 600 FLOW	66
	FOX	67
	OPCIONES Y ACCESORIOS / OPTIONS AND ACCESSORIES	68-69
	CORTINAS DE PROTECCIÓN / PROTECTION CURTAINS	70-71
	MANTAS DE PROTECCIÓN / PROTECTION BLANKETS	72-73

## CARGADORES/CHARGERS

CARGADORES / CHARGERS	Mod.	P.
	INVERCAR 150	78
	INVERCAR 530	79
	INVERCAR 750	80
	INVERCAR 2500	81
	SMARTCAR 1500	82
	NOVACAR	83-85
	STARTER	86
	DIGI-MATIC	87
	AUTONOMY	88-89
	CABLES DE ARRANQUE / START CABLES	90
	PINZAS	91

# PICTOLEYENDA

## PICTO-LEGEND

MMA  
TIG  
MIG MAG  
PLASMA



### FAN ON DEMAND

Ventiladores controlados por electrónicamente, funcionando únicamente cuando el equipo lo precisa. Disminuye la deposición de partículas sobre los componentes electrónicos aumentando su fiabilidad.

### FAN ON DEMAND

Electronically-controlled fans operating only when the equipment needs it. It reduces the deposition of particles on the electronic components, thus increasing their reliability.



### DOUBLE CASE

Construcción en Doble Carcasa integrada con los circuitos electrónicos. Absorbe vibraciones e impactos alargando la vida útil del equipo.

### DOUBLE CASE

Double casing construction integrated with electronic circuits. Absorbs vibrations and impacts, thus lengthening the useful life of the equipment.



### LIFT-ARC

Inicio soldadura TIG por contacto (sin raspado) evitando el desgaste de la punta del electrodo de tungsteno.

### LIFT-ARC

Beginning of the TIG welding by contact (without scraping) avoiding the wear and tear of the tip of the tungsten electrode.



### EFFICIENT DESIGN

Diseño integrado de toda la electrónica y los elementos estructurales optimizando su funcionalidad y rendimientos.

### EFFICIENT DESIGN

Integrated design of all the electronic and structural elements, thus optimizing its functionality and Duty Cycle.



### DIGITAL DISPLAY

Panel de regulación digital para un ajuste preciso de la intensidad de soldadura.

### DIGITAL DISPLAY

Digital control panel for the precise adjustment of the Welding intensity.



### Double fan

Sistema de ventilación doble aumentado el rendimiento del equipo.

### Double fan

Double fan system, thus increasing the equipment's Duty Cycle.



### DDR

Sistema de construcción anti-schok SOLTER en doble componente. Máxima resistencia a impactos y ambientes exigentes.

### DDR

SOLTER anti-shock, double component construction system. Maximum resistance to impacts and demanding environments.



### ARC-SENSE

Sistema de control de la tensión de soldadura para una mayor estabilidad del arco.

### ARC-SENSE

Control system of the welding voltage for a greater arc stability.



#### HOT START, ARC FORCE, ANTI STICK

**Hot Start:** Pre-caletamiento del electrodo en el inicio del cordón de soldadura. Facilita el cebado del arco y evita que el electrodo no se pegue cuando está frío.

**ArcForce:** Permite soldar con arco muy corto INCLUIDO tocando la pieza a soldar. Ideal para posiciones y electrodos difíciles.

**AntiStick:** Reduce la Intensidad si hay cortocircuito. Evita que el electrodo que soldado a la pieza si este se pega.

#### HOT START, ARC FORCE, ANTI STICK

**Hot Start:** Preheating of the electrode at the beginning of the welding seam. It facilitates the spark jump and prevents the electrode from not adhering when it is cold.

**ArcForce:** Allows welding with a very short arc even when the part to be welded is touched. Ideal for difficult positions and electrodes.

**AntiStick:** It reduces the intensity if there is a short circuit. It prevents the electrode welded to the piece from sticking.



#### HF

En soldadura TIG, Ignición de arco por Alta Frecuencia sin necesidad de contacto del electrodo de tungsteno.

#### HF

In TIG welding, ignition of the arc through high frequency without contact of the tungsten electrode being necessary.



#### PULSE

Soldadura TIG por arco Pulsado. Facilita la frecuencia de aporte de material y disminuye la temperatura media de soldadura.

#### PULSE

TIG pulsed arc welding. It facilitates the frequency of filler material and decreases the average welding temperature.



#### TUNNEL FAN

Sistema de ventilación por túnel evitando deposición de partículas en componentes críticos.

#### TUNNEL FAN

Ventilation system through a tunnel, thus avoiding deposition of particles in critical components.



#### DSP

Digital Signal Processing, control digital de la potencia del equipo.

#### DSP

Digital Signal Processing, digital control of the equipment's power.



#### GENERATOR OK

Permite conectar dispositivos electrónicos sensibles a fuentes de corriente inestables. Generadores, Alargaderas...

#### GENERATOR OK

It allows connecting sensitive electronic devices to unstable power source. Generators, extensions...



#### ANTI-SHOCK

Carcasa de alta resistencia con máxima resistencia a los impactos y ambientes exigentes. Probado con cargas de hasta 500 Kg.

#### ANTI-SHOCK

High-resistance housing with maximum resistance to impacts and demanding environments. Tested with loads up to 500kg.



#### IGNIFUGO

Carcasa fabricada en Polímero de Alta Calidad Ignifugo.

#### IGNIFUGO

Housing made of high quality fireproof polymer.



#### AUTOVOLTAGE SENSING

Sensor del voltaje de entrada. El equipo adapta automáticamente la corriente de salida a la tensión de entrada.

#### AUTOVOLTAGE SENSING

Input voltage sensor. The equipment automatically adjusts the output current to the input voltage.



#### PFC

Power Factor Control, disminuye el consumo de equipo pudiéndose conectar este a instalaciones de menos de 16A y a generadores un 30% menos potentes.

#### PFC

Power Factor Control, reduces equipment consumption, whereby it is possible to connect it to installations inferior to 16A and generators 30% less powerful.



# MMA



**ES** - Versatilidad, portabilidad, rendimiento o eficiencia son los principales argumentos de nuestros equipos para soldar con electrodos revestidos (MMA).

No importa el trabajo a realizar ni cuales sean las condiciones. Con los equipos SOLTER siempre encontrará la solución ideal.

**EN** - Versatility, portability, Duty Cycle or efficiency are the main arguments of our equipments for welding with coated electrodes (MMA).

Regardless of the work to be done or the existing conditions. With SOLTER equipment you will always find the ideal solution.





# Inverter *tapp*



## La más ligera del mercado The Lightest One on the Market

### Aplicaciones

Soldadura de todo tipo  
de electrodos revestidos.

Construcciones metálicas en múltiples  
aplicaciones domésticas, mantenimiento  
y reparación.

### Applications

Welding all types of coated electrodes. Metal  
constructions in multiple household applications,  
maintenance and repair.



### ES - Principales características

El modelo TAPP presenta unas características ergonómicas inigualables, siendo el equipo más ligero del mercado, con tan sólo 1,9kg de peso. Todo esto, con una potencia de 90Amp. y capacidad para soldar electrodos de hasta 2,5mm.

- Máxima fiabilidad y resistencia gracias a su sistema de construcción en doble carcasa.
- Facilidad de uso gracias a la tecnología INVERTER suministrando corriente continua DC.
- Mínimo consumo por su alta eficiencia energética.
- Equipado con los dispositivos Anti-stick, Arc-Force y Hot-Start.

### EN - Main features

The TAPP model features unique ergonomic characteristics, the lightest equipment on the market, with a weight of only 1.9kg. All this with a power of 90Amp. and the capacity to weld electrodes up to 2.5mm.

- Maximum reliability and resistance thanks to its double housing construction system.
- Ease of use thanks to the INVERTER technology that supplies DC current.
- Minimum consumption through its high energy efficiency.
- Equipped with Anti-stick, Arc-Force devices and Hot Start.

## Características técnicas Technical Characteristics

			<b>TAPP 1500E</b>
<b>Intensidad soldadura MMA</b> Welding intensity MMA			<b>90A</b>
<b>Rendimiento MMA</b> Duty Cycle MMA	<b>40°C</b>	<b>25%</b>	
	<b>20°C</b>	<b>40%</b>	
<b>Electrodos utilizables MMA</b> Usable electrodes MMA			<b>1,6 - 2,5 mm</b>
<b>Corriente de pico</b> Peak current			100A
<b>Rango de regulación MMA</b> Regulation range MMA			10-90A (20,4 -23,6V)
<b>Intensidad a (40°C)</b> Intensity by (40°C)	60%	40A	
	100%	20A	
<b>Conexión</b> Connection			230V - 1ph
<b>Rango de utilización</b> Voltage range			180 - 270V
<b>Voltaje en vacío</b> Open circuit voltage			95V
<b>Potencia absorbida max.</b> Max. absorbed power			3,2Kva
	<b>Imax</b>	14A	
	<b>Ieff</b>	6A	
<b>Fusible mínimo recomendado</b> Minimum fuse recommended			10A
<b>Panel regulación</b> Regulation panel			Micro
<b>Ventilación</b> Ventilation			Ventilador simple Simple fan
<b>Índice de protección</b> Protection index			IP23C
<b>Dimensiones / Dimensions</b>			245x110x190 mm
<b>Peso / Weight</b>			1,9 kg
<b>Normas / Standards</b>			EN-60974-1, EN-60974-10
<b>REF</b>			<b>04246</b>

## Electrodos/H Electrodes/H

<b>TAPP</b>	<b>1,6</b>	<b>2,0</b>	<b>2,5</b>
<b>TAPP 1500</b>	CONT	30	20



## Accesorios Accessories



73033

INCLUIDO | INCLUDED

## Versatilidad y diseño compacto Versatility and Compact Design

### Ámbito de Aplicación

Soldadura de todo tipo de electrodos revestidos.  
Construcciones metálicas en múltiples aplicaciones domésticas, mantenimiento y reparación.

### Application Range

Welding all types of coated electrodes.  
Metal constructions in multiple household applications, maintenance and repair.



### ES - Principales características

Los modelos COTT son equipos INVERTER de soldadura de electrodos revestidos que destacan por su alta versatilidad y amplio campo de aplicación. Esta gama alcanza valores sorprendentes en cuanto a su relación peso-volumen-prestaciones, siendo indicados tanto para trabajos particulares como de mantenimiento en la industria.

- 3,5 kg siendo extremadamente compactos y portátiles.
- Máxima fiabilidad y resistencia gracias a su sistema de construcción en doble carcasa.
- Facilidad de uso gracias a la tecnología INVERTER suministrando corriente continua DC.
- Mínimo consumo por su alta eficiencia energética.
- Equipado con los dispositivos Anti-stick , Arc-Force y Hot-Start.
- Conectable a generadores con un amplio rango de voltajes de utilización.

### EN - Main features

COTT models are INVERTER welding equipment of coated electrodes that stand out for their high versatility and wide range of applications. This range reaches surprising values in terms of its relationship weight-volume-Duty Cycle, being useful both for private work, as well as for maintenance in the industry.

- 3.5 kg, which are extremely compact and portable.
- Maximum reliability and resistance thanks to its doublehousing construction.
- Ease of use thanks to the INVERTER technology that supplies DC current.
- Minimum consumption through its high energy efficiency.
- Equipped with Anti-stick, Arc-Force devices and Hot-Start.
- Connectable to generators with a wide voltage range.



### Características técnicas Technical Characteristics

			<b>COTT 155</b>
<b>Intensidad soldadura MMA</b> Welding intensity MMA			<b>150A</b>
<b>Rendimiento MMA</b> Duty Cycle MMA	<b>40°C</b> <b>20°C</b>		<b>35%</b> <b>50%</b>
<b>Electrodos utilizables MMA</b> Usable electrodes MMA			<b>1,6 - 4,0 mm</b>
<b>Corriente de pico</b> Peak current			<b>170A</b>
<b>Rango de regulación MMA</b> Regulation range MMA			<b>10-150A (20,4 -26V)</b>
<b>Intensidad a (40°C)</b> Intensity by (40°C)	<b>60%</b> <b>100%</b>		<b>90A</b> <b>65A</b>
<b>Conexión</b> Connection			<b>230V-1ph</b>
<b>Rango de utilización</b> Voltage range			<b>180V - 280V</b>
<b>Voltaje en vacío</b> Open circuit voltage			<b>75V</b>
<b>Potencia absorbida max.</b> Max. absorbed power			<b>6,2Kva</b>
	<b>Imax</b> <b>Ieff</b>		<b>26A</b> <b>15,3A</b>
<b>Fusible mínimo recomendado</b> Minimum fuse recommended			<b>16A</b>
<b>Panel regulación</b> Regulation panel			<b>Micro</b>
<b>Ventilación</b> Ventilation			<b>Ventilador simple</b> <b>Simple fan</b>
<b>Índice de protección</b> Protection index			<b>IP23C</b>
<b>Dimensiones / Dimensions</b>			<b>230x120x255 mm</b>
<b>Peso / Weight</b>			<b>3,5 kg</b>
<b>Normas / Standards</b>			<b>EN-60974-1, EN-60974-10</b>
<b>REF</b>			<b>04137</b>



### Electrodos/H Electrodes/H

<b>COTT</b>	<b>1,6</b>	<b>2,0</b>	<b>2,5</b>	<b>3,25</b>	<b>4,0</b>
<b>COTT 155</b>	CONT	CONT	CONT	35	10



### Accesorios Accessories



06123



06124



75012



74351

INCLUIDO | INCLUDED

EXCEPTO 155E |  
EXCEPT 155E

## Máxima potencia mínimo peso Maximum Power, Minimum Weight

### Ámbito de Aplicación

Soldadura de todo tipo de electrodos revestidos.

Mantenimiento y reparación Industrial.

Soldadura TIG en aceros al carbono e inoxidable.

### Application Range

Welding all types of coated electrodes.

Industrial maintenance and repair.

TIG welding by carbon steel and stainless steel.



### ES - Principales características

La línea COTT SD aplica toda la tecnología INVERTER en unos modelos extremadamente compactos. A su destacada capacidad en soldadura de electrodos revestidos, destaca la posibilidad de soldar también mediante el procedimiento TIG Lift-Arc.

- Máxima potencia (200Amp.) con el mínimo peso (4 kg).
- Máxima fiabilidad y resistencia gracias a su sistema de construcción en doble carcasa.
- Facilidad de uso gracias a la tecnología INVERTER, suministrando corriente continua DC.
- Mínimo consumo por su alta eficiencia energética.
- Equipado con los dispositivos Anti-stick , Arc-Force, Hot-Start y Lift-Arc (TIG).
- Conectable a generadores con un amplio rango de voltajes de utilización.
- Con Tecnología SUPERBOOST, incrementando el rendimiento en más de un 15%.

### EN - Main features

The COTT SD line applies the entire INVERTER technology by some extremely compact models. Apart from its outstanding capacity of welding of coated electrodes, there is also the possibility of welding using the TIG Lift-Arc procedure.

- Maximum power (200Amp.) with minimum weight (4kg).
- Maximum reliability and resistance thanks to its double housing construction.
- Ease of use thanks to the INVERTER technology that supplies DC current.
- Minimum consumption through its high energy efficiency.
- Equipped with Anti-stick , Arc-Force devices, Hot-Start and Lift-Arc (TIG).
- Connectable to generators with a wide voltage range.
- Powered with SUPERBOOST technology, increasing the duty cycle in more than 15%



Características técnicas  
Technical Characteristics

COTT	175 SD   175E	195 SD   195E
<b>Intensidad soldadura MMA</b> Welding intensity MMA	160A	200A
<b>Rendimiento MMA</b> Duty Cycle MMA	40°C 20°C	45% 60%
<b>Electrodos utilizables MMA</b> Usable electrodes MMA	1,6 - 4,00 mm	1,6 - 4,00 mm
<b>Intensidad soldadura TIG</b> Welding intensity TIG	180A   160A	200A
<b>Rendimiento TIG</b> Duty Cycle TIG	40°C 20°C	45% 60%
<b>Electrodos utilizables TIG</b> Usable electrodes TIG	1,0 - 2,4 mm	1,0 - 2,4 mm
<b>Corriente de pico</b> Peak current	180A	210A
<b>Rango de regulación MMA</b> Regulation range MMA	10-160A (20,4 -26,4V)	10-200A (20,4-28V)
<b>Intensidad a (40°C)</b> Intensity by (40°C)	60% 100%	110A 85A
<b>Rango de regulación TIG</b> Regulation range TIG	10-180A (10,4-17,2V)	10-200A (10,4-18V)
<b>Intensidad a (40°C)</b> Intensity by (40°C)	60% 100%	130A 100A
<b>Conexión / Connection</b>	230V-1ph	230V-1ph
<b>Rango de utilización</b> Voltage range	180V - 280V	180V - 280V
<b>Voltaje en vacío</b> Open circuit voltage	95V	95V
<b>Potencia absorbida max.</b> Max. absorbed power	6,5 Kva	8 Kva
	Imax Ieff	29A 17,5A
<b>Fusible mínimo recomendado</b> Minimum fuse recommended	16A	16A
<b>Panel regulación / Regulation panel</b>	Digital   Analogic	Digital   Analogic
<b>Ventilación / Ventilation</b>	Ventilador simple/ Simple fan	Ventilador simple/ Simple fan
<b>Índice de protección / Protection index</b>	IP23C	IP23C
<b>Dimensiones / Dimensions</b>	315x135x285 mm	315x135x285 mm
<b>Peso / Weight</b>	3,9 kg	4 kg
<b>Normas / Standards</b>		EN-60974-1, EN-60974-10
<b>REF</b>	04253   04241	04254   04250

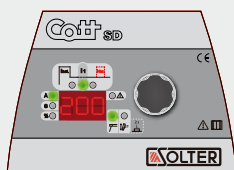
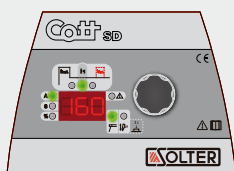

Electrodos/H  
Electrodes/H

COTT	1,6	2,0	2,5	3,25	4,0
<b>175 SD / E</b>	CONT	CONT	CONT	37	10
<b>195 SD / E</b>	CONT	CONT	CONT	40	12

Accesorios  
Accessories



06123 / 06125

INCLUIDO | INCLUDED



06124 / 06126



75130

EXCEPTO "E" |  
EXCEPT "E"



74351



06024 / 06031

OPCIONAL | OPTIONAL



# Inverter **STYL/PRO**



## Potencia sin límites Power without limits

### Ámbito de Aplicación

Soldadura de todo tipo de electrodos revestidos, rutilos, básicos e incluso Celulósicos.  
Mantenimiento y reparación Industrial.  
Soldadura TIG en aceros al carbono e inoxidable.

### Application Range

Welding all types of coated, rutile, basic or even CEL electrodes. Industrial maintenance and repair.  
TIG welding by carbon steel and stainless steel.



### ES - Principales características

La línea STYL y STYL PRO aplica toda la tecnología INVERTER en modelos compactos y con potencias que van desde los 160 hasta los 200 amperios. A su destacada capacidad en soldadura de electrodos revestidos, destaca la posibilidad de soldar también mediante el procedimiento TIG.

- Máxima potencia (160 / 200 Amp.) con el mínimo peso (4,5 kg. / 7,5 Kg.)
- Facilidad de uso gracias a la tecnología INVERTER suministrando corriente continua DC.
- Mínimo consumo por su alta eficiencia energética.
- Equipado con los dispositivos Anti-stick, Arc-Force, Hot-Start y Lift-Arc (TIG).
- Conectable a generadores con un amplio rango de voltajes de trabajo.

### EN - Main features

The STYL and STYL PRO line applies the INVERTER technology by some compact models and with power ranging from 160 to 200 amperes. Apart from its outstanding capacity of welding of coated electrodes, there is also the possibility of welding using the TIG procedure.

- Maximum power (160 / 200 Amp.) with minimum weight(4.5kg / 7.5kg).
- Ease of use thanks to the INVERTER technology that supplies DC current.
- Minimum consumption through its high energy efficiency.
- Equipped with Anti-stick, Arc-Force devices, Hot-Start and Lift-Arc (TIG).
- Connectable to generators with a wide voltage range.



Características técnicas  
Technical Characteristics



STYL	185 DI   185 E	205 DI   205 E
<b>Intensidad soldadura MMA</b> Welding intensity MMA	160A	200A
<b>Rendimiento MMA</b> Duty Cycle MMA	40°C 20°C	50% 70%
<b>Electrodos utilizables MMA</b> Usable electrodes MMA	1,6 - 4,00 mm	1,6 - 4,00 mm
<b>Intensidad soldadura TIG</b> Welding intensity TIG	180A   160A	220A   200A
<b>Rendimiento TIG</b> Duty Cycle TIG	40°C 20°C	50% 70%
<b>Electrodos utilizables TIG</b> Usable electrodes TIG	1,0 - 2,4 mm	1,0 - 3,2 mm
<b>Corriente de pico</b> Peak current	180A	220A
<b>Rango de regulación MMA</b> Regulation range MMA	10-160A (20,4 -26,4V)	10-200A (20,4 -28V)
<b>Intensidad a (40°C)</b> Intensity by (40°C)	60% 100%	140A 100A
<b>Rango de regulación TIG</b> Regulation range TIG	10-180A   10-160A (10,4-17,2V)	10-220A   10-200A (10,4-18,8V)
<b>Intensidad a (40°C)</b> Intensity by (40°C)	60% 100%	170A 110A
<b>Conexión / Connection</b>	230V-1ph	230V-1ph
<b>Rango de utilización</b> Voltage range	180V - 280V	180V - 280V
<b>Voltaje en vacío</b> Open circuit voltage	80V	80V
<b>Potencia absorbida max.</b> Max. absorbed power	6,6 kva	9,5 kva
	Imax Ieff	38A 29A
<b>Fusible mínimo recomendado</b> Minimum fuse recommended	16A	16A
<b>Panel regulación / Regulation panel</b>	"Digital"   "Analogic"	"Digital"   "Analogic"
<b>Ventilación / Ventilation</b>	Ventilador doble/ Double fan	Ventilador doble/ Double fan
<b>Índice de protección / Protection index</b>	IP23C	IP23C
<b>Dimensiones / Dimensions</b>	305x115x225 mm	305x115x225 mm
<b>Peso / Weight</b>	4,5 kg	7,5 kg
<b>Normas / Standards</b>	EN-60974-1, EN-60974-10	
<b>REF</b>	04109   04251	04110   04252

Electrodos/H  
Electrodes/H

STYL	1,6	2,0	2,5	3,25	4,0
<b>185 Di / 185 E</b>	CONT	CONT	CONT	CONT	20
<b>205 Di / 205 E</b>	CONT	CONT	CONT	CONT	CONT

Accesorios  
Accessories



06008 / 06125

INCLUIDO | INCLUDED



06009 / 06126



75130

EXCEPTO "E" |  
EXCEPT "E"



74351



06024/06031

OPCIONAL | OPTIONAL

## La gama alta, lo mejor The Top Line, the Best

### Ámbito de Aplicación

Soldadura de todo tipo de electrodos revestidos, rutilos, básicos e incluso Celulósicos.

Mantenimiento, reparación industrial, montajes, construcciones metálicas.

Soldadura TIG en aceros al carbono e inoxidable.

### Application Range

Welding all types of coated, rutile, basic or even CEL electrodes. Industrial maintenance, repair, assembly, metal constructions. TIG welding by carbon steel and stainless steel.



### ES - Principales características

Hablar de soldadura profesional es hablar de la línea de productos iCON. Por su diseño constructivo DDR patentado e innovador, por su gran capacidad de trabajo bajo condiciones intensivas y ambientes exigentes y por sus inigualables resultados en cuanto fiabilidad y prestaciones, esta es sin duda la mejor opción para los profesionales mas exigentes.

- Estabilidad y control de arco con independencia de la distancia electrodo-material, gracias a la regulación por ARCSENSE.
- Doble ventilación automática, actuando únicamente cuando el equipo lo precisa.
- Posición STAND-BY, cuando el equipo no se encuentra en funcionamiento.
- Mínimo consumo por su alta eficiencia energética.
- Equipado con los dispositivos Anti-stick , Arc-Force, Hot-Start y Lift-Arc (TIG).
- Conectable a generadores con un amplio rango de voltajes de trabajo.

### EN - Main features

When we talk about Profesional Welding, we are talking about ICON. Thanks to its DDR patented and innovative building design, its great capacity of work under intensive conditions and demanding environments and because it has incomparable results referring to the reliability and Duty Cycle, this is undoubtedly the best choice for the most demanding professionals.

- Stability and control of the arc irrespective of the distance between the electrode-material, thanks to the adjustment by ARCSENSE.
- Automatic Double fan, which functions only when the equipment needs it.
- STAND-BY position when the equipment is not functioning.
- Minimum consumption through its high energy efficiency.
- Equipped with Anti-stick, Arc-Force devices, Hot-Start and Lift-Arc (TIG).
- Connectable to generators with a wide voltage range.

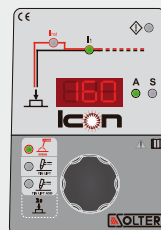

### Características técnicas Technical Characteristics

iCON 1855		
<b>Intensidad soldadura MMA</b> Welding intensity MMA		<b>160A</b>
<b>Rendimiento MMA</b> Duty Cycle MMA	<b>40°C</b> <b>20°C</b>	<b>45%</b> <b>60%</b>
<b>Electrodos utilizables MMA</b> Usable electrodes MMA		<b>1,6 - 4,00 mm</b>
<b>Intensidad soldadura TIG</b> Welding intensity TIG		<b>180A</b>
<b>Rendimiento TIG</b> Duty Cycle TIG	<b>40°C</b> <b>20°C</b>	<b>45%</b> <b>60%</b>
<b>Electrodos utilizables TIG</b> Usable electrodes TIG		<b>1,0 - 2,4 mm</b>
<b>Corriente de pico</b> Peak current		ARC-SENSE
<b>Rango de regulación MMA</b> Regulation range MMA		5-160A (20,2 -26,4V)
<b>Intensidad a (40°C)</b> Intensity by (40°C)	60% 100%	140A 100A
<b>Rango de regulación TIG</b> Regulation range TIG		5-180A (10,2-17,2V)
<b>Intensidad a (40°C)</b> Intensity by (40°C)	60% 100%	150A 110A
<b>Conexión</b> Connection		230V-1ph
<b>Rango de utilización</b> Voltage range		180V - 300V
<b>Voltaje en vacío</b> Open circuit voltage		80V
<b>Potencia absorbida max.</b> Max. absorbed power		6,6 kva
	Imax Ieff	29A 19A
<b>Fusible mínimo recomendado</b> Minimum fuse recommended		16A
<b>Panel regulación</b> Regulation panel		iCON "Digital"
<b>Ventilación</b> Ventilation		Ventilador doble AUTO Double fan AUTO
<b>Índice de protección</b> Protection index		IP23C
<b>Dimensiones / Dimensions</b>		320X135X285 mm
<b>Peso / Weight</b>		4,5 kg
<b>Normas / Standards</b>		EN-60974-1, EN-60974-10
<b>REF</b>		<b>04228</b>



### Electrodos/H Electrodes/H

iCON	1,6	2,0	2,5	3,25	4,0
<b>iCON 1855</b>	CONT	CONT	CONT	CONT	20

### Accesorios Accessories



06008 CU 25 2M.

INCLUIDO | INCLUDED



06009 CU25 3M.



75130

OPCIONAL | OPTIONAL



06024



## Máxima potencia en alta gama Maximum High Range Power

### Ámbito de Aplicación

Soldadura de todo tipo de electrodos revestidos como rutilo, básicos, inoxidables, aluminio y celulósicos (iCON-2070 DIGICEL).  
Reparación industrial, montajes, construcciones metálicas, calderería.  
Soldadura TIG en aceros al carbono e inoxidable.

### Application Range

Welding all types of coated electrodes, such as rutile, basic, stainless steel, aluminum and cellulosic (iCON-2070 DIGICEL). Industrial maintenance, repair, assembly, metal constructions, boiler-making. TIG welding by carbon steel and stainless steel.



### ES - Principales características

La línea de productos iCON PRO es igual a potencia en su máxima expresión. Estos equipos INVERTER, junto a su diseño constructivo DDR patentado e innovador, su gran capacidad de trabajo bajo condiciones intensivas y ambientes exigentes y por sus inigualables resultados en cuanto fiabilidad, aportan también un plus de potencia para trabajos intensivos en electrodos de hasta 4 mm.

- Estabilidad y control de arco con independencia de la distancia electrodo material, gracias a la regulación por ARCSENSE.
- Doble ventilación automática, actuando únicamente cuando el equipo lo precisa.
- Posición STAND-BY cuando el equipo no se encuentra en funcionamiento.
- Mínimo consumo por su alta eficiencia energética.
- Equipado con los dispositivos Anti-stick, Arc-Force, Hot-Start y Lift-Arc (TIG)
- Conectable a generadores con un amplio rango de voltajes de trabajo.
- iCON 206 PFC, conectable a instalaciones monofásicas de 100V a 230V (+/- 15%)

### EN - Main features

The product line of iCON PRO is the maximum of power. This INVERTER equipment, together with its DDR patented and innovative building design, its great capacity of work under intensive conditions and demanding environments and because it has incomparable results referring to the reliability contributes a power plus for intensive work with electrodes up to 4mm.

- Stability and control of the arc irrespective of the distance between the electrode-material, thanks to the adjustment by ARCSENSE.
- Automatic Double fan, which functions only when the equipment needs it.
- STAND-BY position when the equipment is not functioning.
- Minimum consumption through its high energy efficiency.
- Equipped with Anti-stick, Arc-Force devices, Hot-Start and Lift-Arc (TIG).
- Connectable to generators with a wide voltage range.
- iCON 206 PFC, connectable to 1ph power supply from 100V to 230V (+/- 15%)



Características técnicas  
Technical Characteristics

		ICON 2055 PRO	ICON 2060 PFC	ICON 2070 DIGICEL
<b>Intensidad soldadura MMA</b> Welding intensity MMA		200A	170A	180A
<b>Rendimiento MMA</b> Duty Cycle MMA	40°C 20°C	50% 75%	35% 65%	45% 60%
<b>Electrodos utilizables MMA</b> Usable electrodes MMA		1,6 - 4,00 mm	1,6 - 4,00 mm	1,6 - 4,00 mm
<b>Intensidad soldadura TIG</b> Welding intensity TIG		200A	180A	200A
<b>Rendimiento TIG</b> Duty cycle (40°C)	40°C 20°C	50% 75%	30% 55%	45% 60%
<b>Electrodos utilizables TIG</b> Usable electrodes TIG		1,0 - 3,2 mm	1,0 - 2,4 mm	1,0 - 2,4 mm
<b>Corriente de pico</b> Peak current		ARC-SENSE	ARC-SENSE	ARC-SENSE
<b>Rango de regulación MMA</b> Regulation range MMA		5-200A (20,2 -28V)	5-170A (20,2 -26,8V) 5-90A (20,4-23,6V)	5-180A (20,2 -27,2V)
<b>Intensidad a (40°C)</b> Intensity by (40°C)	60% 100%	180A 120A	120A 80A	160A 110A
<b>Rango de regulación TIG</b> Regulation range TIG		5-220A (10,2 -18,8V)	5-180A (10,4 -17,2V) 5-150A (10,4-16V)	5-200A (10,2 -18V)
<b>Intensidad a (40°C)</b> Intensity by (40°C)	60% 100%	180A 120A	130A 80A	160A 110A
<b>Conexión</b> Connection		230V-1ph	100 - 230 V 1ph (+15/- 15%) 1ph	230V-1ph
<b>Rango de utilización</b> Voltage range		80V - 300V	85V - 265V	180V - 300V
<b>Voltaje en vacío</b> Open circuit voltage		68V	70V	92V
<b>Potencia absorbida max.</b> Max. absorbed power	Imax Ieff	9,5KVA 42A 29,7A	4,6KVA 20A 14,26A	8,5KVA 37A 24,8A
<b>Fusible mínimo recomendado</b> Minimum fuse recommended		16A	16A	16A
<b>Panel regulación</b> Regulation panel		iCON "Digital"	iCON "Digital"	iCON "DigiCel"
<b>Ventilación</b> Ventilation		Ventilador doble AUTO Double fan AUTO	Ventilador doble AUTO Double fan AUTO	Ventilador doble AUTO Double fan AUTO
<b>Indice de protección</b> Protection index		IP23C	IP23C	IP23C
<b>Dimensiones / Dimensions</b>		430x175x325 mm	430x175x325 mm	430x175x325 mm
<b>Peso / Weight</b>		6,4 kg	6,7 kg	6,9 Kg
<b>Normas / Standards</b>		EN-60974-1, EN-60974-10		
<b>REF</b>		<b>04229</b>	<b>04116</b>	<b>04175</b>



Electrodos/H  
Electrodes/H

ICON PRO	1,6	2,0	2,5	3,25	4,0
ICON 2055 PRO	CONT	CONT	CONT	CONT	CONT
ICON 2060 PFC	CONT	CONT	CONT	CONT	30
ICON 2070 DIGICEL	CONT	CONT	CONT	CONT	CONT



Accesorios  
Accessories



06125

INCLUIDO | INCLUDED



06126



75139

OPCIONAL | OPTIONAL



06031

## El Inverter trifásico (3ph) más potente The Most Powerful Triphase (3ph) Inverter



### Accesorios Accessories



56151

OPCIONAL | OPTIONAL

Características técnicas Technical Characteristics	AEROARC 320	AEROARC 320 BT
---	-------------	----------------

<b>Conexión</b> Connection	3ph - 400V	400V - 3ph - 220V
<b>Intensidad soldadura MMA</b> Welding intensity MMA		320A 280A
<b>Rendimiento MMA</b> 40°C Duty Cycle MMA 20°C	40% 60%	
<b>Electrodos utilizables MMA</b> Usable electrodes MMA		1,6 - 5,0 mm
<b>Intensidad soldadura TIG</b> Welding intensity TIG	320A	320A 280A
<b>Rendimiento TIG</b> 40°C Duty Cycle TIG 20°C	45% 65%	
<b>Electrodos utilizables TIG</b> Usable electrodes TIG		1,6 - 4,0 mm
<b>Corriente de pico</b> Peak current		Arc sense digital
<b>Rango de regulación MMA</b> Regulation range MMA	5 - 320A (20,2-32,8V)	5 - 320A 5 - 280A
<b>Intensidad a (40°C)</b> 60% Intensity by (40°C) 100%	280A 250A	280A 260A 250A 220A
<b>Conexión</b> Connection	400V - 3ph	400V - 3ph - 220V
<b>Rango de utilización</b> Voltage range	+ / - 15%	+ / - 15%
<b>Voltaje en vacío</b> Open circuit voltage	62V   10V (VRD)	62V   67V   10V (VRD)
<b>Potencia absorbida max.</b> Max. absorbed power		15,3 KVA
<b>Fusible mínimo recomendado</b> Minimum fuse recommended		16A
<b>Panel de regulación</b> Regulation panel		Aeroarc Digital
<b>Ventilación</b> Ventilation		TUNEL / TUNNEL auto
<b>Índice de protección</b> Protection index		IP 23
<b>Dimensiones / Dimensions</b>		655x275x410 mm
<b>Peso / Weight</b>		23 kg
<b>Normas / Standards</b>		EN 60974-1, EN 60974-10
<b>REF</b>	<b>56127</b>	<b>56249</b>

### ES - Principales características

Equipo de soldadura con tecnología INVERTER y conexión trifásica (3ph - 400V). ideal para trabajos intensivos tanto en electrodos revestidos de hasta 5mm como en TIG Lift-Arc.

- \* Gran rendimiento gracias a sus 320 amperios de potencia al 45%.
- \* Extremadamente portátil con una relación peso-rendimiento sin igual con tan solo 23kg.
- \* Arc-Force y Hot-Start regulables para una mejor ignición del arco en condiciones difíciles (electrodos húmedos, superficies oxidadas etc...).

### EN - Main features

3ph INVERTER welding power source. Suitable for intensive welding applications up to 5mm welding electrodes and TIG Lift-Arc.

- \* High duty cycle supplying 320A at 45 %.
- \* Extremely portable weighing 23kg only.
- \* Settable Arc-Force and Hot-Start to get a better arc ignition in difficult circumstances (wet electrodes, oxidated surfaces...etc)

# AEROPROCESS 4000

## Fuente de potencia CC/CV CC/CV Power Source



### 15 CC/CV Devanador con sensor de voltaje Voltage sensing wire feeder



#### ES - Principales características

- \* Fuente de potencia CC / CV con control de corriente constante y control del voltage constante.
- \* Perfectos resultados en soldadura MMA, con Arc-Force y Hot - Start ajustables y control de dinámica de arco.
- \* Sistema de estabilización en MMA, compatible con todos los electrodos.
- \* Soldadura TIG-LiftArc
- \* Soldadura MIG-MAG, con alimentador de hilo remoto AEROCASE-15 CC/CV, con ajuste de voltage , inductancia y soft-start.

#### EN - Main features

- \* Power Source CC / CV with constant current and constant voltage control.
- \* Perfect results in MMA welding, with adjustable Arc -Force and Hot-Start, and arc dynamics control.
- \* MMA stabilization system, compatible with all types of electrodes.
- \* TIG-LiftArc
- \* MIG-MAG welding, with voltage-sensing wire feeder AEROCASE-15 CC/CV. Equipped with adjustable voltage, inductance and soft -start.

#### Características técnicas Technical Characteristics

AEROPROCESS		4000		
<b>Conexión</b> Connection		<b>3ph 400V</b> (360-440VAC)		
<b>Rendimiento MMA 40°C</b> Duty cycle MMA		35%	60%	100%
		420A	385A	350A
		36,8V	35,4V	34V
<b>Rendimiento TIG 40°C</b> Duty cycle TIG		35%	60%	100%
		420A	385A	350A
		26,8V	25,4V	24V
<b>Rendimiento MIG-CV 40°C</b> Duty cycle MIG-CV		35%	60%	100%
		420A	385A	350A
		35V	33,3V	31,5V
<b>Potencia absorbida max.</b> Max. absorbed power	<b>Imax</b> Ieff	34A 20A		
<b>Voltaje en vacío</b> Open circuit voltage		70/12(VRD)		
<b>Eficiencia (%)</b> Efficiency (%)		88		
<b>Factor potencia</b> Power factor		0,7		
<b>Fusible mínimo recomendado</b> Minimum fuse recommended		20A		
<b>Panel de regulación</b> Regulation panel		Digital		
<b>Ventilación</b> Ventilation		Double automatic Tunel		
<b>Peso neto (kg) / Weight (Kg)</b>		27kg		
<b>Tipos electrodos</b> Electrode type		6010,6011,6013,7018,etc.		
<b>Dimensiones / Dimensions</b>		655x275x410 mm		
<b>Diámetro electrodo / Electrode diameter</b>		2,5 , 3,2 , 4,0 , 5,0		
<b>Índice de protección</b> Protection index		IP 23		
<b>Normas / Standards</b>		EN 60974-1, EN 60974-10		
<b>REF</b>	<b>56165</b>			



# Rectificadores Rectifiers

SC

SOLTER

## Ámbito de Aplicación

Soldadura de todo tipo de electrodos revestidos como rutilo, básicos, inoxidable, aluminio y celulósicos.  
Construcción, obra pública y recargues.  
Conducciones de gas y oleoductos con soldaduras de compromiso.

## Application Range

Welding all types of coated electrodes, as well as rutile, basic, stainless steel, aluminum and cellulose ones. Construction, public works and recharges. Gas piping and oil pipelines with difficult welding.



## ES - Principales características

La línea de rectificadores de corriente continua SC, son la mejor opción cuando se precisa robustez y gran capacidad de trabajo. Con potencias de hasta 450 amperios y el suministro de corriente continua DC permiten soldar con cualquier electrodo de forma continua.

- Regulación de corriente de soldadura por SHUNT

## EN - Main features

The line of SC direct current rectifiers are the best choice when you need robustness and a great work capacity. With power of up to 450 amperes and the supply of direct current any electrode can be used to weld in a continuous manner.

- Welding current regulation by SHUNT

## Características técnicas Technical Characteristics

### SC 450

<b>Intensidad soldadura</b> Welding intensity		<b>400A</b>
<b>Rendimiento</b> Duty cycle MMA	<b>40°C</b> <b>20°C</b>	<b>35%</b> <b>45%</b>
<b>Electrodos utilizables</b> Usable electrodes		<b>1,6 - 6 mm</b>
<b>Intensidad a (40°C)</b> Intensity by (40°C)	60% 100%	305A 237A
<b>Corriente de pico</b> Peak pulse current		450A
<b>Rango de regulación</b> Regulation range MMA		10-400A (20,4-36V)
<b>Conexión</b> Connection		230V/400V - 3ph (+/- 20%)
<b>Potencia absorbida max.</b> Max. absorbed power		26 kva
<b>Fusible</b> Fuse		32A
<b>Voltaje en vacío</b> Open circuit voltage		62V
<b>Regulación</b> Regulation range		Shunt
<b>Ventilación</b> Ventilation		Ventilador simple Simple fan
<b>Indice de protección</b> Protection index		IP23
<b>Dimensiones / Dimensions</b>		1000x550x750 mm
<b>Peso / Weight</b>		112 kg
<b>Normas / Standards</b>		EN 60974-1, EN 60974-10
<b>REF</b>		<b>56197</b>

# Transformadores **SB**

## Transformateurs

### Ámbito de Aplicación

Soldadura de todo tipo de electrodos revestidos.  
Construcciones metálicas en múltiples aplicaciones domésticas, mantenimiento y reparación.

### Application Range

Welding all types of coated electrodes.  
Metal constructions in multiple household applications, maintenance and repair.



MMA

Transformadores SB  
Transformers SB

Rectificadores SC  
Rectifiers SC

### ES - Principales características

Transformadores de corriente alterna AC, con protección termostática y turbo-ventilados.

### EN - Main features

Alternating current AC transformers with thermostatic protection and turbo-ventilated.



### SB 1000 TURBO

<b>Rango de regulación</b> Regulation range	<b>10-160A</b> <b>(20,4 - 26,4V)</b>
<b>Conexión</b> Connection	230V - 1ph (+/- 20%)
<b>Potencia absorbida max.</b> Max. absorbed power	2 - 5KVA
<b>Fusible</b> Fuse	25A
<b>Voltaje en vacío</b> Open circuit voltage	50V
<b>Regulación</b> Regulation	Shunt
<b>Ventilación</b> Ventilation	Ventilador simple Simple fan
<b>Indice de protección</b> Protection index	IP23
<b>Dimensiones / Dimensions</b>	385x245x256 mm
<b>Peso / Weight</b>	16 kg
<b>Normas / Standards</b>	EN 60974-1, EN 60974-10
<b>REF</b>	<b>01053</b>

### Características técnicas Technical Characteristics

# TIG

**ES** - Soldar TIG significa precisión y capacidad de regulación. Mediante los equipo iCONTIG DC y AEROTIG AC/DC de SOLTER podrá soldar todo tipo de materiales como inoxidable o aluminio, espesores extremadamente finos o mas gruesos e incluso, mediante el sistema AeroCool, realizar trabajos continuos que precisen refrigeración por agua.

**EN** - Welding TIG means accuracy and regulation capacity. Through iCONTIG DC and AEROTIG AC/DC equipment from SOLTER you will be able to weld all kinds of materials, such as stainless steel or aluminum, thicknesses that are extremely thin or thicker and even, through the AeroCool system, carry out continuous work requiring water cooling.





## La máxima precisión en alta gama The Maximum High Range Precision

### Ámbito de aplicación:

Soldadura TIG de todo tipo de aceros al carbono e inoxidables.

Soldadura de todo tipo de electrodos revestidos como rutilo, básicos e inoxidables.

Calderería, conducciones de gases y líquidos, depósitos, trabajos de mantenimiento en la industria etc

### Application Range

TIG welding by all types of carbon steel and stainless steel. Welding all types of coated electrodes, such as rutile, basic and stainless steel ones. Boiler-making, piping of gas and liquids, deposits, maintenance work in the industry, etc.



### ES - Principales características

iCONTIG significa precisión. Por su diseño constructivo DDR patentado e innovador, por su gran capacidad de trabajo bajo condiciones intensivas y ambientes exigentes y por sus inigualables resultados en cuanto fiabilidad y prestaciones, esta es sin duda, la mejor opción para los profesionales más exigentes.

- Estabilidad y control de arco con independencia de la distancia electrodo-material gracias a la regulación por ARCSENSE.
- Doble ventilación automática, actuando únicamente cuando el equipo lo precisa.
- Posición STAND-BY, cuando el equipo no se encuentra en funcionamiento.
- Mínimo consumo por su alta eficiencia energética.
- Equipado con los dispositivos Anti-stick, Arc-Force, Hot-Start y Lift-Arc (TIG).
- Conectable a generadores con un amplio rango de voltajes de trabajo.

### EN - Main features

iCONTIG means precision. Due to its DDR patented and innovative building design, its great capacity of work under intensive conditions and demanding environments and because it has incomparable results referring to the reliability and performance, this is undoubtedly the best choice for the most demanding professionals.

- Stability and control of the arc irrespective of the distance between the electrode-material, thanks to the adjustment by ARCSENSE.
- Automatic double ventilation, which functions only when the equipment needs it.
- STAND-BY position when the equipment is not functioning.
- Minimum consumption through its high energy efficiency.
- Equipped with Anti-stick, Arc-Force devices, Hot-Start and Lift-Arc (TIG).
- Connectable to generators with a wide voltage range.



Características técnicas  
Technical Characteristics

		ICONTIG 1880 HF	ICONTIG 1990 HF PULSE
<b>Intensidad soldadura TIG</b> Welding intensity TIG		<b>180A</b>	<b>180A</b>
<b>Rendimiento TIG</b> Duty cycle TIG	<b>40°C</b> <b>20°C</b>	<b>50%</b> <b>75%</b>	<b>50%</b> <b>75%</b>
<b>Electrodos utilizables TIG</b> Usable electrodes TIG		<b>1,0 - 2,4 mm</b>	<b>1,0 - 2,4 mm</b>
<b>Intensidad soldadura MMA</b> Welding intensity MMA		<b>160A</b>	<b>160A</b>
<b>Rendimiento MMA</b> Duty cycle MMA	<b>40°C</b> <b>20°C</b>	<b>45%</b> <b>70%</b>	<b>45%</b> <b>70%</b>
<b>Electrodos utilizables MMA</b> Usable electrodes MMA		<b>1,6 - 4,00 mm</b>	<b>1,6 - 4,00 mm</b>
<b>Rango de regulación TIG</b> Regulation range TIG		10-180A (10,4 - 17,2V)	10-180A (10,4 - 17,2 V)
<b>Intensidad a (40°C)</b> Intensity by (40°C)	<b>60%</b> <b>100%</b>	140A 110A	140A 110A
<b>Rango de regulación MMA</b> Regulation range MMA		10-160A (20,4-26,4)	10 - 160A (20,4 - 26,4 V)
<b>Intensidad a (40°C)</b> Intensity by (40°C)	<b>60%</b> <b>100%</b>	130A 100A	130A 100A
<b>Conexión / Connection</b>		230V-1ph	230V-1ph
<b>Voltajes</b> Voltage		120V - 310V	120V - 310V
<b>Potencia absorbida max.</b> Max. absorbed power		6,5KVA	6,5KVA
<b>Fusible mín. recomendado / Minimum fuse recommended</b>		16A	16A
<b>Frecuencia de pulsado / Pulsed frequency</b>			Max.: 500 Hz
<b>Voltaje en vacío / Open circuit voltage</b>		80V	80V
<b>Panel frontal / Front panel</b>		iCONTIG "basic"	iCONTIG "pulse"
<b>Ventilación / Ventilation</b>		Doble / Double AUTO	Doble / Double AUTO
<b>Indice de protección / Protection index</b>		IP23C	IP23C
<b>Dimensiones / Dimensions</b>		320x135x285 mm	320x135x285 mm
<b>Peso / Weight</b>		4,9 kg	4,9 kg
<b>Normas / Standards</b>		060974-1 , 060974-10	
<b>REF</b>		<b>04176</b>	<b>04173</b>



Accesorios  
Accessories



06148

INCLUIDO | INCLUDED



75139

OPCIONAL | OPTIONAL



56151



06145



06009



70608



56026

## Precisión y potencia en gama alta High Range Precision and Power

### Ámbito de Aplicación

Soldadura TIG de todo tipo de aceros al carbono e inoxidables.

Soldadura de todo tipo de electrodos revestidos como rutilo, básicos e inoxidables.

Calderería, conducciones de gases y líquidos, depósitos, trabajos de mantenimiento en la industria etc...

### Application Range

TIG welding by all types of carbon steel and stainless steel.

Welding of all types of coated electrodes, such as rutile, basic and stainless steel ones. Boiler-making, piping of gas and liquids, deposits, maintenance work in the industry, etc.



### ES - Principales características

iCONTIG PRO es el mejor compromiso entre precisión y potencia. Por su diseño constructivo DDR patentado e innovador, por su gran capacidad de trabajo bajo condiciones intensivas y ambientes exigentes y por sus inigualables resultados en cuanto a fiabilidad, prestaciones y potencia, esta es sin duda, la mejor opción para los profesionales más exigentes.

- Estabilidad y control de arco, con independencia de la distancia electrodo-material gracias a la regulación por ARCSENSE.
- Doble ventilación automática, actuando únicamente cuando el equipo lo precisa.
- Posición STAND-BY, cuando el equipo no se encuentra en funcionamiento.
- Mínimo consumo por su alta eficiencia energética.
- Equipado con los dispositivos Anti-stick, Arc-Force, Hot-Start y Lift-Arc / HF (TIG).
- Conectable a generadores con un amplio rango de voltaje de trabajo.
- iCONTIG 2260 PFC, conectable a instalaciones monofásicas de 100V a 230V (+/- 15%)

### EN - Main features

iCONTIG PRO is the best compromise between accuracy and power. Due to its DDR patented and innovative building design, its great capacity of work under intensive conditions and demanding environments and because it has incomparable results referring to the reliability and performance, this is undoubtedly the best choice for the most demanding professionals.

- Stability and control of the arc irrespective of the distance between the electrode-material, thanks to the adjustment by ARCSENSE.
- Automatic double ventilation, which functions only when the equipment needs it.
- STAND-BY position when the equipment is not functioning.
- Minimum consumption through its high energy efficiency.
- Equipped with Anti-stick, Arc-Force devices, Hot-Start and Lift-Arc (TIG).
- Connectable to generators with a wide voltage range.
- iCON 2260 PFC, connectable to 1ph power supply from 100V to 230V (+/- 15%).



### Características técnicas Technical Characteristics

	ICONTIG 2220 HF PULSE		ICONTIG 2260 HF PFC
<b>Intensidad soldadura TIG</b> Welding intensity TIG	230V 115V	220A	180A 150A
<b>Rendimiento TIG</b> Duty cycle TIG	40°C 20°C	80% 90%	35% 55%
<b>Electrodos utilizables TIG</b> Usable electrodes TIG		1,0 - 3,2 mm	1,0 - 3,2 mm
<b>Intensidad soldadura MMA</b> Welding intensity MMA	230V 115V	200A	170A 100A
<b>Rendimiento MMA</b> Duty cycle MMA	40°C 20°C	60% 75%	35% 65%
<b>Electrodos utilizables MMA</b> Usable electrodes MMA		1,6 - 4,00 mm	1,6 - 4,00 mm
<b>Rango de regulación TIG</b> Regulation range TIG		10 - 220A (10,4 - 18,8V)	10-180A (10,4-17,2V)/ 10-150A (10,4-16V)
<b>Intensidad a (40°C)</b> Intensity by (40°C)	60% 100%	200A (80%) 160A	130A 80A
<b>Rango de regulación MMA</b> Regulation range MMA		10 - 200A (20,4 - 28,0V)	10-170A (20,4-26,8)/ 10-90A (20,4-23,6)
<b>Intensidad a (40°C)</b> Intensity by (40°C)	60% 100%	200A 150A	120A 80A
<b>Conexión</b> Connection		230V-1ph	230V - 115V (+/-20%)
<b>Voltajes</b> Voltage		120V - 310V	85V - 275V
<b>Potencia absorbida max.</b> Max. absorbed power		8,5KVA	4,6Kva
<b>Fusible mín. recomendado / Minimum fuse recommended</b>		25A	16A
<b>Frecuencia de pulsado / Pulsed frequency</b>		500 Hz	500 Hz
<b>Voltaje en vacío / Open circuit voltage</b>		68V	70V
<b>Panel frontal / Front panel</b>		iCONTIG "pulse"	iCONTIG "pulse"
<b>Ventilación / Ventilation</b>		DOBLE / double auto	DOBLE / double auto
<b>Indice de protección / Protection index</b>		IP23C	IP23C
<b>Dimensiones / Dimensions</b>		430x175x325 mm	430x175x325 mm
<b>Peso / Weight</b>		7,2 Kg	7,5 Kg
<b>Standards / Standards</b>		EN 60974-1, EN 60974-10	EN 60974-1, EN 60974-10
<b>REF</b>		<b>04194</b>	<b>04117</b>



### Accesorios Accessories

	AEROCOOL 20
<b>Conexión / Connection</b>	230V-1ph
<b>Potencia Absorbida / Absorbed power</b>	400w
<b>Potencia refrigeración / Refrigeration power</b>	0,8 kw
<b>Presión máxima / Maximum pressure</b>	350kpa
<b>Capacidad depósito / Deposit capacity</b>	4L
<b>Dimensiones / Dimensions</b>	270x240x540 mm
<b>Peso / Weight</b>	18 Kg
<b>REF</b>	<b>56130</b>



06165

INCLUIDO | INCLUDED



75139

OPCIONAL | OPTIONAL



56151



06168



06126



70608



56026



## El Inverter TIG-DC Inverter TIG-DC

### Ámbito de Aplicación

Soldadura TIG DC de aceros al carbono, inoxidable... etc. Soldadura de electrodos revestidos MMA como rutilos, básicos o celulósicos. Para trabajos continuos en tuberías, caldererías, producción industrial...etc.

### Application Range

Carbon steel, stainless steel DC TIG welding, etc. Welding of coated MMA electrodes, such as rutile, basic or cellulose. For continuous work on pipes, boiler making, industrial production, etc.

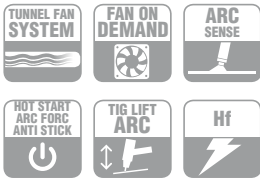

### ES - Principales características

La fuente de potencia AeroTig DC está diseñada para trabajar bajo condiciones y aplicaciones extremas tanto en electrodo MMA como TIG. Gracias a sus 320A/420A (250A/350A al 100%) es ideal para trabajos continuos.

- Tecnología patentada “Low Voltage Inverter”, siendo un 30% mas eficiente que fuentes de potencia Inverter convencionales.
- Tecnología “Digital ArcSense”, con lectura a tiempo real del arco 75.000 veces por segundo.
- Control totalmente digital de la curva de soldadura.
- Doble ventilación automática tipo túnel, actuando únicamente cuando el equipo lo precisa.

### EN - Main features

The AeroTig DC power supply source is designed to work under extreme conditions and applications either in the case of an MMA, as well as a TIG electrode. Thanks to its 320A/420A (250A/350A - 100%), it is ideal for continuous work.

- “Low Voltage Inverter” patented technology, still 30% more efficient than conventional sources of power Inverter.
- “Digital ArcSense” technology, with real time reading of the arc 75,000 times per second.
- Fully digital control of the welding curve.
- Automatic tunnel-type double ventilation, which functions only when the equipment needs it.



### Características técnicas Technical Characteristics

<b>AEROTIG DC</b>		<b>3320 DC</b>	<b>4320DC</b>
<b>Conexión</b> Connecting voltage		<b>3ph-400V</b>	<b>3ph - 400V</b>
<b>Intensidad soldadura TIG</b> Welding intensity TIG		<b>320A</b>	<b>420A</b>
<b>Rendimiento TIG</b> Duty cycle TIG	<b>40°C</b> <b>20°C</b>	<b>45%</b> <b>65%</b>	<b>35%</b> <b>60%</b>
<b>Electrodos utilizables TIG</b> Usable electrodes TIG		<b>1,0 - 4,0 mm</b>	<b>1,0 - 4,0mm</b>
<b>Intensidad soldadura MMA</b> Welding intensity MMA		<b>320A</b>	<b>420A</b>
<b>Rendimiento MMA</b> Duty Cycle MMA	<b>40°C</b> <b>20°C</b>	<b>40%</b> <b>60%</b>	<b>35%</b> <b>60%</b>
<b>Electrodos utilizables MMA</b> Usable electrodes MMA		<b>1,0 - 6,0mm</b>	<b>1,0 - 8,0mm</b>
<b>Rango de regulación TIG</b> Regulation range TIG		<b>10 - 320A (10,4 - 20,8V)</b>	<b>10 - 420A (10,4 - 20,8V)</b>
<b>Intensidad a (40°C)</b> Intensity by (40°C)	<b>60%</b> <b>100%</b>	<b>280A</b> <b>250A</b>	<b>385A</b> <b>350A</b>
<b>Rango de regulación MMA</b> Regulation range MMA		<b>10-320A (20,2 - 32,8V)</b>	<b>10-420A (20,4 - 36,8V)</b>
<b>Intensidad a (40°C)</b> Intensity by (40°C)	<b>60%</b> <b>100%</b>	<b>280A</b> <b>250A</b>	<b>385A</b> <b>350A</b>
<b>Voltajes</b> Voltage		<b>360-440V</b>	<b>360-440V</b>
<b>Potencia absorbida max.</b> Max. absorbed power		<b>15,3 KVA</b>	<b>20 KVA</b>
<b>Fusible mín. recomendado / Minimum fuse recommended</b>		<b>16A</b>	<b>20A</b>
<b>Frecuencia de pulsado / Pulsed frequency</b>		<b>MAX.:500 Hz</b>	<b>MAX.: 3000 Hz</b>
<b>Voltaje en vacío / Open circuit voltage</b>		<b>62V/12V (VRD)</b>	<b>70V/12V (VRD)</b>
<b>Panel frontal / Front panel</b>		<b>AEROTIG</b>	<b>AEROTIG</b>
<b>Ventilación / Ventilation</b>		<b>DOUBLE auto TUNNEL</b>	<b>DOUBLE auto TUNNEL</b>
<b>Indice de protección / Protection index</b>		<b>IP23</b>	<b>IP23</b>
<b>Dimensiones / Dimensions</b>		<b>655x281x700mm</b>	<b>655x281x700mm</b>
<b>Peso / Weight</b>		<b>26 Kg</b>	<b>28 Kg</b>
<b>Normas / Standards</b>		<b>EN 60974-1, EN 60974-10</b>	<b>EN 60974-1, EN 60974-10</b>
<b>REF</b>		<b>56218</b>	<b>56166</b>



### Accesorios Accessories

	<b>AEROCOOOL 30</b>
<b>Conexión / Connection</b>	<b>400V-3ph</b>
<b>Potencia Absorbida / Absorbed power</b>	<b>400w</b>
<b>Potencia refrigeración / Refrigeration power</b>	<b>0,90 kw</b>
<b>Presión máxima / Maximum pressure</b>	<b>350kpa</b>
<b>Capacidad depósito / Deposit capacity</b>	<b>4L</b>
<b>Dimensiones / Dimensions</b>	<b>250x270x600</b>
<b>Peso / Weight</b>	<b>20 KG</b>
<b>REF</b>	<b>56172</b>



06130

INCLUIDO | INCLUDED



56173

OPCIONAL | OPTIONAL



06034



06126



56026



70608



06029



56076

## La solución TIG AC/DC

### The Solution TIG AC/DC

#### Ámbito de Aplicación

Soldadura TIG de todo tipo de aceros al carbono, inoxidables y aluminio.

Soldadura de todo tipo de electrodos revestidos como rutilo, básicos, inoxidables y aluminio.

Calderería, conducciones de gases y líquidos de todo tipo de tuberías, depósitos, trabajos de mantenimiento en la industria etc...

#### Application Range

TIG welding by all types of carbon steel, stainless steel and aluminium. Welding of all types of coated electrodes, such as rutile, basic, stainless steel and aluminum ones.

Boiler-making, piping of gas and liquids of all types of pipes, deposits, maintenance work in the industry, etc.



#### ES - Principales características

La serie de equipos AEROTIG AC/DC, son la solución TIG profesional completa por excelencia. Gracias a su potentísimo INVERSOR AC/DC se consiguen increíbles resultados tanto en aceros al carbono e inoxidables como muy especialmente en multitud de aleaciones de ALUMINIO.

- Estabilidad y control de arco, con independencia de la distancia electrodo-material gracias a la regulación por ARCSENSE.
- Control sinérgico "Auto Mode", de los parámetros AC (balance-frecuencia-offset) facilitando su óptima y fácil regulación.
- Doble ventilación automática, actuando únicamente cuando el equipo lo precisa.
- Posición STAND-BY, cuando el equipo no se encuentra en funcionamiento.
- Mínimo consumo por su alta eficiencia energética.
- Equipado con los dispositivos Anti-stick, Arc-Force, Hot-Start y Lift-Arc / HF (TIG).

#### EN - Main features

The series of AEROTIG AC/DC equipment is the complete TIG professional solution. Thanks to its very powerful AC/DC INVERTER, incredible results are being achieved both in carbon steel and stainless steel, especially in a multitude of ALUMINUM alloys.

- Stability and control of the arc irrespective of the distance between the electrode-material, thanks to the adjustment by ARCSENSE.
- Synergic "Auto Mode" control of the AC parameters (balance-frequency-offset) facilitates their optimum and easy regulation.
- Automatic double ventilation, which functions only when the equipment needs it.
- STAND-BY position when the equipment is not functioning.
- Minimum consumption through its high energy efficiency.
- Equipped with Anti-stick, Arc-Force devices, Hot-Start and Lift-Arc (TIG).



Características técnicas  
Technical Characteristics

<b>AEROTIG AC/DC</b>		<b>2330</b>	<b>4330</b>
<b>Conexión</b> Connecting voltage		<b>1ph-230V</b>	<b>3ph-400V</b>
<b>Intensidad soldadura TIG</b> Welding intensity TIG		<b>200A</b>	<b>350A</b>
<b>Rendimiento TIG</b> Performance TIG	<b>40°C</b>	<b>45%</b>	<b>40%</b>
<b>Electrodos utilizables TIG</b> Usable electrodes TIG		<b>1,0 - 3,20 mm</b>	<b>1,0 - 4,00 mm</b>
<b>Intensidad soldadura MMA</b> Welding intensity MMA		<b>200A</b>	<b>350A</b>
<b>Rendimiento MMA</b> Duty cycle MMA	<b>40°C</b>	<b>45%</b>	<b>40%</b>
<b>Electrodos utilizables MMA</b> Usable electrodes MMA		<b>1,6 - 4,0 mm</b>	<b>1,0 - 6,0 mm</b>
<b>Rango de regulación TIG</b> Regulation range TIG		<b>10 - 200A (10,4 - 18,0V)</b>	<b>10 - 350A (10,4 - 24V)</b>
<b>Intensidad a (40°C)</b> Intensity by (40°C)	<b>60%</b> <b>100%</b>	<b>170A</b> <b>140A</b>	<b>270A</b> <b>220A</b>
<b>Rango de regulación MMA</b> Regulation range MMA		<b>10 - 200A (20,4-28V)</b>	<b>10 - 350A (20,4-34V)</b>
<b>Intensidad a (40°C)</b> Intensity by (40°C)	<b>60%</b> <b>100%</b>	<b>160A</b> <b>130A</b>	<b>270A</b> <b>220A</b>
<b>Voltaje/Voltages</b> <b>Potencia absorbida max.</b> Max. absorbed power		<b>180V-280V</b> <b>9,5KVA</b>	<b>360-440V</b> <b>20KVA</b>
<b>Fusible mínimo recomendado</b> Minimum fuse recommended		<b>25A</b>	<b>20A</b>
<b>Frecuencia de pulsado</b> Pulsed frequency		<b>MAX.:500Hz</b>	<b>MAX.:3.000Hz</b>
<b>Voltaje en vacío</b> Open circuit voltage		<b>65V</b>	<b>72V/12V (VRD)</b>
<b>Panel frontal / Front panel</b>		<b>AEROTIG "ac/dc pulse"</b>	<b>AEROTIG "ac/dc pulse"</b>
<b>Ventilación</b> Ventilation		<b>DOBLE</b> Double <b>AUTO</b>	<b>DOBLE auto TUNNEL</b> Double auto <b>TUNNEL</b>
<b>Indice de protección</b> Protection index		<b>IP23</b>	<b>IP23</b>
<b>Dimensiones / Dimensions</b>		<b>465x280x360 mm</b>	<b>655x281x700 mm</b>
<b>Peso / Weight</b>		<b>14 kg</b>	<b>26 kg</b>
<b>Normas / Standards</b>		<b>EN 60974-1, EN 60974-10</b>	<b>EN 60974-1, EN 60974-10</b>
<b>REF</b>		<b>56133</b>	<b>56139</b>

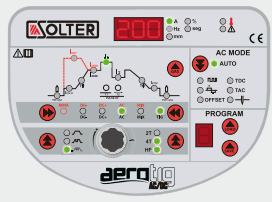

Accesorios  
Accessories

	<b>AEROCOOL 20</b>	<b>AEROCOOL 30</b>
<b>Conexión / Connection</b>	<b>230V-1ph</b>	<b>400V-3ph</b>
<b>Potencia Absorbida/ Absorbed power</b>	<b>400w</b>	<b>400w</b>
<b>Potencia refrigeración /Refrigeration power</b>	<b>0,8 kw</b>	<b>0,90 kw</b>
<b>Presión máxima /Maximum pressure</b>	<b>350kpa</b>	<b>350kpa</b>
<b>Capacidad deposito / Deposit capacity</b>	<b>4L</b>	<b>4L</b>
<b>Dimensiones / Dimensions</b>	<b>270x240x540</b>	<b>250x270x600</b>
<b>Peso / Weight</b>	<b>18 KG</b>	<b>20 KG</b>
<b>REF</b>	<b>56130</b>	<b>56172</b>



06165 / 06130      56151 / 56173      06034      06126      56026      70608      06029      56076  
 INCLUIDO | INCLUDED      OPCIONAL | OPTIONAL

# MIG MAG



**ES** - Productividad es lo que define nuestra fuentes de potencia MIG-MAG. Compactos o con devanadera separada, tradicionales, Sinérgicos o con tecnología INVERTER, siempre encontrará la solución perfecta a sus necesidades.

**EN** - Productivity is what defines our MIG-MAG power sources. Compact or with separate reel, traditional, synergistic or with INVERTER technology, you will always find the perfect solution for your needs.



## La línea MIG-MAG mas accesible The Most Accessible MIG-MAG line



La Línea de equipos SOLMIG, és el eslabón de entrada a la línea MIG MAG de SOLTER, ideales para trabajos ligeros, diseñados para ser fáciles e intuitivos de usar. Su conexión monofásica, así como la posibilidad de usar hilo sin gas externo gracias a la inversión de polaridad (solo Solmig 160) les confieren una enorme flexibilidad.

- Conexión Monofásica a 230V.
- 4 y 6 Puntos de Regulación.
- Temporizador regulable hasta 15s:

### ES - Principales características

Los equipos SOLMIG són la línea de acceso a la familia de productos MIG-MAG. Económicos, portátiles y con máxima versatilidad.

- Esquipos monofasicos a 230V.
- El modelo Solmig 160 puede soldar con o sin gas.
- El modelo Solmig-180 equipado con euroconector.

The SOLMIG equipment line is the entry link to the MIG MAG SOLTER line, ideal for light work, designed to be easy and intuitive to use. Its single-phase connection, as well as the possibility of using wire without external gas thanks to the polarity reversal (only Solmig 160) gives it enormous flexibility.

- Single-phase 230V connection.
- 4 and 6 points of regulation.
- Timer adjustable to 15s

### EN - Main features

SOLMIG equipment is the access line to the MIG-MAG product family. Economic, portable and with maximum versatility.

- Single-phase 230V equipment.
- The model Solmig 160 can weld with or without gas.
- The model Solmig-180 is equipped with an Euro Connector.



### Características técnicas Technical Characteristics

		SOLMIG 160 GAS/NO GAS	SOLMIG 180
<b>Rango de regulación</b> Regulation		20-150A	30-180A
<b>Rendimiento</b> Duty cycle	40°C	15%	15%
	20°C	25%	25%
<b>Hilo utilizable</b> Usable wire		0,6 - 1,0 mm	0,6 - 1,0 mm
<b>Intensidad soldadura</b> Welding intensity		105A	155A
<b>Intensidad a (40°C)</b> Intensity by (40°C)	60%	65A	85A
	100%	45A	60A
<b>Conexión / Connection</b>		230V - 1ph (+/- 20%)	230V - 1ph (+/- 20%)
<b>Potencia absorbida max.</b> Max. absorbed power		5,6kva	5,6kva
<b>Fusible / Fuse</b>		16A	16A
<b>Voltaje en vacío</b> Open circuit voltage		35V	30V
<b>Rodillos arrastre</b> Rolls		2R	2R
<b>Velocidad de hilo</b> Wire speed		0...12m/min	0...14m/min
<b>Bobina hilo utilizable max.</b> Usable wire reel		D200 - 5 kg	D300 - 15 kg
<b>Puntos de regulación</b> Regulation points		4	6
<b>Ventilación</b> Ventilation		Ventilador simple / Ventilation simple	Ventilador simple / Ventilation simple
<b>Índice de protección</b> Protection index		IP 21S	IP 21S
<b>Dimensiones / Dimensions</b>		415x245x310 mm	780x330x600 mm
<b>Peso / Weight</b>		22 kg	48 kg
<b>Normas / Standards</b>		EN90791-1, EN60974-10	
<b>REF</b>		<b>54002</b>	<b>54004</b>

### Accesorios Accessories

INCLUIDO | INCLUDED

#### SOLMIG 160



06001



56003



06021

#### SOLMIG 180



56031



INCLUIDO | INCLUDED



## INVERTER MIG-MAG multiproceso INVERTER MIG-MAG multiprocess

### Ámbito de aplicación:

Construcciones metálicas, automoción,  
reparación industrial, tuberías...etc

### Application Range:

Metal construction, automotive, industrial repair,  
pipe welding..etc.



### ES - Principales características

La línea AEROPROCESS representa el paso definitivo en equipos de soldadura de hilo MIG-MAG Multiproceso. No importa el proceso (MIG-MAG, TIG, MMA), el material a soldar (Acero, Inoxidable, Aluminio, Cusi3...). Su potente regulación sinérgica le permitirá en todo momento un excelente control del arco con unos resultados extraordinarios.

- Equipo multifunción capaz de soldar mediante los procesos MIG-MAG (Aeroproces 2000 Gas/No Gas), TIG Lift-Arc y Electrodo MMA.
- Control sinérgico del proceso de soldadura con preselección del trabajo a realizar.
- Ideal para soldaduras con GAP (separación entre piezas)
- Excelentes resultados con programas pre-cargados en la soldadura de Acero al Carbono (SG3), Inoxidables (Ss-309, Ss-316), Aluminio (AL-5356, AL-4043), Cobre-Silicio (CuSi3), Tubulares (Fc-Rutile, Fc-Basic, Fc-316)
- Posibilidad de ajuste por espesor de material (mm) o velocidad de hilo (m/min.), lectura permanente de tensión (Volt) e Intensidad (Amp) y control del consumo del hilo utilizado, permitiendo calcular el costo de cada proceso.
- Posibilidad de almacenar hasta 10 programas.
- Crater Filling regulable para un acabado de cordón de soldadura perfecto

### EN - Main features

The AEROPROCESS line represents the final step MIG-MAG multiprocess welding machines. No matter the process (MIG-MAG, TIG, MMA) or the material to be welded (Steel, Stainless, Aluminum, CuSi3 ....). Its powerful synergic regulation will bring an excellent arc control with extraordinary results.

- Multi-process, capable of MIG-MAG welding (AEROPROCESS-2000 Gas/No Gas), Lift-Arc TIG and MMA.
- Synergic control with welding process presetting.
- Ideal for welding with GAP (separation).
- Excellent results with pre-loaded programs in carbon steel welding (SG3), Stainless-steel (Ss -309 , Ss -316) , Aluminum (AL- 5356, AL- 4043), Copper-Silicon (CuSi3) , Flux-cored wires (Fc-Rutile, Fc-Basic , Fc-316).
- Possibility to adjust material thickness (mm) or wire-speed (m/min). Permanent voltage (V) - Intensity (A) reading. Wire consumption control, allowing calculate the cost of each process.
- Possibility to store up to 10 programs.
- Crater Filling for a perfect end of weld seam.



### Características técnicas Technical Characteristics

AEROPROCESS		2000	3200	3220 DV
<b>Conexión</b> Connection voltage		1ph- 230V	3ph- 400V   3ph- 200/440V	3ph- 400V   3ph 200/440V
<b>Intensidad soldadura</b> Welding intensity		200A	320A	320A
<b>Rendimiento</b> Duty cycle	40°C	45%	40%	40%
	20°C	68%	60%	60%
<b>Hilo utilizable</b> Usable wire		0,6 - 1,2 mm	0,6 - 1,2 mm	0,6 - 1,2 mm
<b>Rango de regulación</b> Regulatio		20 - 200A (15 -24V)	20 - 320A (15 - 30V)	20 - 320A (15 -30V)
<b>Intensidad a (40°C)</b> Intensity by (40°C)	60%	170A	280A	280A
	100%	130A	250A	250A
<b>Potencia absorbida max.</b> Max. absorbed power		9kva	15,3 Kva	15,3 Kva
<b>Fusible / Fusible</b>		25A	16A	16A
<b>Voltaje en vacío /</b> Open circuit voltage		54V	62V	62V
<b>Rodillos arrastre</b> Rolls		2R	4R	4R
<b>Potencia motor</b> Motor power		30W	65W	65W
<b>Velocidad de hilo</b> Wire speed		0....10m/min	0....18m/min	0....18m/min
<b>Bobina hilo utilizable max.</b> Usable wire coil		D300 - 15 kg	D300 - 15 kg	D300 - 15 kg
<b>Regulación</b> Regulation		Synergic	Synergic	Synergic
<b>Ventilación / Ventilation</b>		Force	Tunel	Tunel
<b>Indice de protección</b> Protection index		IP23	IP23	IP23
<b>Dimensiones / Dimensions</b>		520x270x380 mm	920x270x640 mm	920x270x860 mm
<b>Peso / Weight</b>		19 kg	36 kg	54 kg
<b>Normas / Standards</b>		EN 90791-1, EN 60974-10		
<b>REF.</b>		<b>56168</b>	<b>56204   56234</b>	<b>56211  </b>



### Accesorios Accessories



06130

INCLUIDO | INCLUDED



56032

OPCIONAL | OPTIONAL



56052 - ALU



56026

## INVERTER MIG-MAG multiproceso PULSADO PULSED INVERTER MIG-MAG multiprocess

### Ámbito de aplicación:

Soldadura MIG-MAG INVERTER de altas prestaciones con control total del arco de soldadura. Maxima productividad con el menor consumo energético.

### Application Range

High performance MIG-MAG INVERTER welding with total control of the welding arc.  
Maximum productivity with the minimum energy consumption.



### ES - Principales características

La fuente de potencia AEROPROCESS está diseñada para trabajar bajo condiciones y aplicaciones extremas tanto en hilo MIG-MAG como electrodo MMA o TIG-Lift. Gracias a sus 420Amp es ideal para trabajos continuos.

- Arco-Pulsado y Doble-Pulsado con ajuste de 55 programas y materiales predefinidos.
- Arco estable sin proyecciones, gracias a su control digital de la dinámica y su sistema dinámico de transferencia MIG Arc-Force.
- Modo con "Control de Penetración" supervisando la energía del arco.
- Control antorcha Push-Pull integrado.

### EN - Main Features

The AEROPROCESS power source is designed to work under extreme conditions and applications both on MIG-MAG wire, as well as a MMA electrode or TIG-Lift. Thanks to its 420Amp it is ideal for continuous work.

- Pulsed and Double-Pulsed Arc with Synergic control with 55 preset programs and materials.
- Stable arc without spatters, thanks to its digital control of arc-dynamics, and dynamic transfer system MIG Arc-Force.
- Equipped with "Penetration Control" mode, supervising the arc energy.
- Integrated Push - Pull torch control.

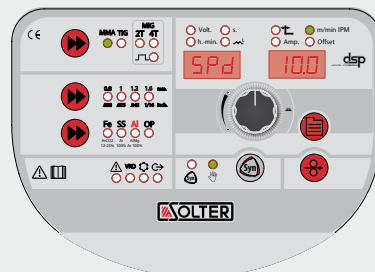

## Características técnicas Technical Characteristics

### AEROPROCESS

4200 / 4200 PULSE

<b>Conexión</b> Connection	<b>3ph 400V</b> (360 - 440V)		
<b>Rendimiento MMA 40°C</b> Duty cycle MMA	45%	60%	100%
	420A	385A	350A
	36,8V	35,4V	34V
<b>Rendimiento TIG 40°C</b> Duty cycle TIG	45%	60%	100%
	420A	385A	350A
	26,8V	25,4V	24V
<b>Rendimiento MIG-CV 40°C</b> Duty cycle MIG-CV	45%	60%	100%
	420A	385A	350A
	35V	33,3V	31,5V
<b>Potencia absorbida max.</b> Max. absorbed power	23KVA		
<b>Fusible</b> Fusible	20A		
<b>Voltaje en vacío</b> Open circuit voltage	70/12(VRD)		
<b>Eficiencia (%)</b> Efficiency (%)	88		
<b>Factor potencia</b> Power factor	0,7		
<b>Rango regulación MIG MAG</b> Regulation MIG MAG	10-420A (14,5 - 35,0V)		
<b>Tipos electrodos</b>	6010,6011,6013,7018,etc.		
<b>Rango regulación MMA</b> Regulation MMA	10-420A (20,4 - 36,8V)		
<b>Voltaje en vacío</b> Open circuit voltage	70VDC/12VDC (VRD)		
<b>Rodillo arrastre</b> Rolls	4R, Doble Tensor		
<b>Potencia motor</b> Motor power	95W		
<b>Bobina hilo utilizable máx.</b> Usable wire reel	D300 - 15Kg.		
<b>Velocidad del hilo</b> Wire speed	25m/min		
<b>Ventilación</b> Ventilation	Double automatic Tunnel		
<b>Peso neto (kg) / Weight (Kg)</b>	27kg (power source)		
<b>Dimensiones / Dimensions</b>	655x275x 930/1220 mm		
<b>Indice protección / Protection Index</b>	IP23		
<b>Normas / Standards</b>	EN 90791-1 , EN 60974 - 10		

REF

56167

### AEROCOOL 30

<b>Conexión / Connection</b>	400V-3ph
<b>Potencia Absorbida / Absorbed power</b>	400w
<b>Potencia refrigeración / Refrigeration power</b>	0,90 kw
<b>Presión máxima / Maximum pressure</b>	350kpa
<b>Capacidad depósito / Deposit capacity</b>	4L
<b>Dimensiones / Dimensions</b>	250x270x600
<b>Peso / Weight</b>	20 KG
<b>REF</b>	56172

## Accesorios Accessories



73052

06126

56173

70608

56026

06029/56076

56033/56077 ALU

INCLUIDO |  
INCLUDED

OPCIONAL | OPTIONAL

# PLASMA



**ES** - No importa el trabajo o del grosor del material a cortar. Con línea Solcut podrá realizar cortes precisos consiguiendo máxima productividad

**EN** - No matter what type of work or the thickness of the material to be cut. With the Solcut line you will be able to make accurate cuts achieving maximum productivity.

# ANTORCHA PLASMA PT 60

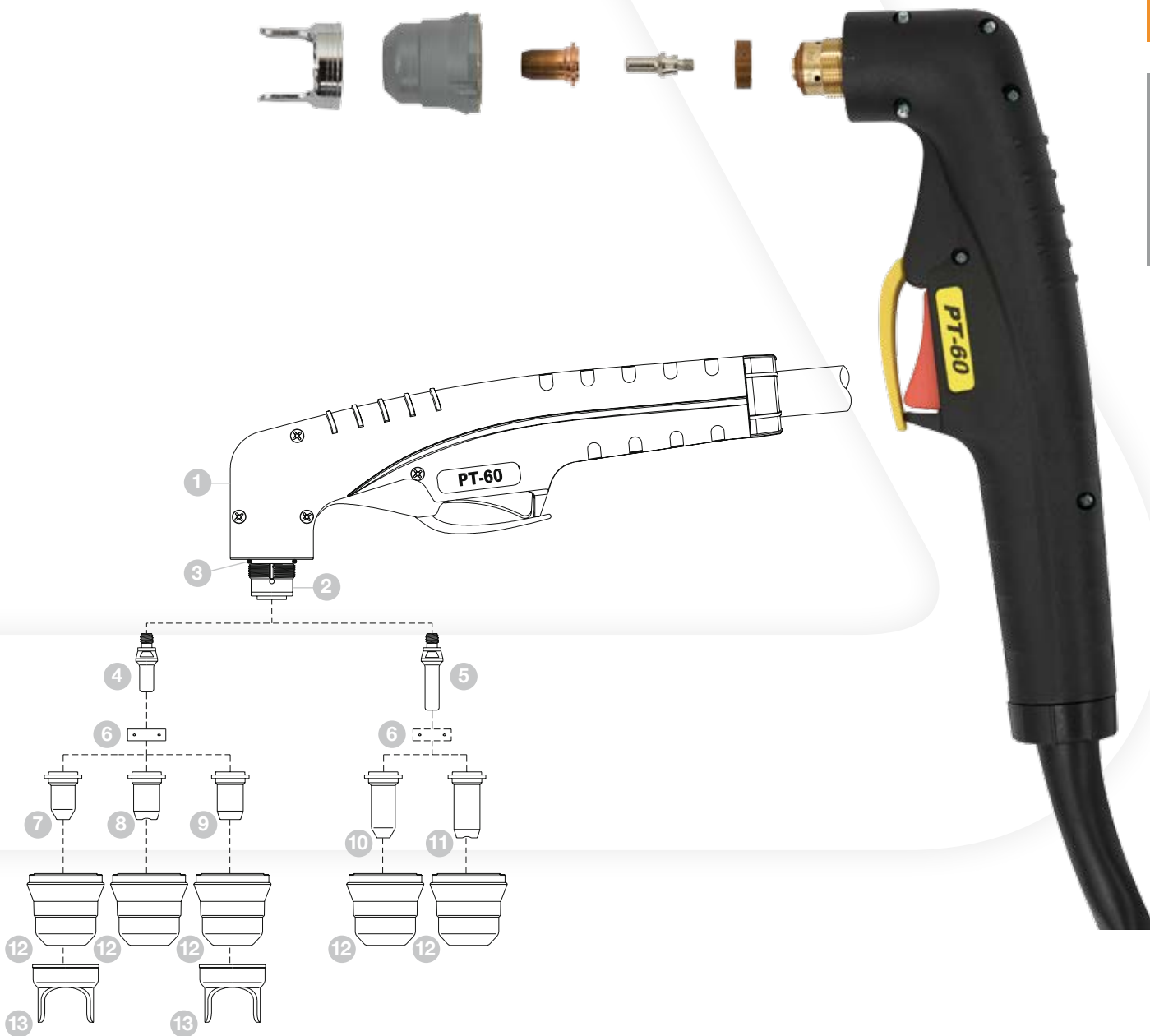

	REF.
1   Antorcha PT-60   Torch PT-60	55971
2   Cabezal de antorcha   Torch neck	55976
3   Junta cabezal de antorcha   Board Neck torch	55977
4   Electrodo corto   Short electrode	55985
5   Electrodo largo   Long electrode	55979
6   Difusor vespel   Diffusor	56046
7   Buza corta 0,65 10-20A   Short nozzle	55972
7   Buza corta 0,80 20-30A   Short nozzle	55974

	REF.
8   Buza corta 0,90 30-40A contact   Short nozzle	55982
8   Buza corta 1,00 40-50A   Short nozzle	55983
9   Buza corta 1,10 50-60A   Short nozzle	55984
10   Buza corta 0,65 10-20A   Short nozzle	55973
10   Buza corta 0,80 20-30A   Short nozzle	55975
11   Buza larga 0,90 30-40A contact   Long nozzle	55978
12   Porta buza   Nozzle holder	55980
13   Patín   Support	55981

# SolCUT 40



## SOLCUT - 40 1PH-230V

### Ámbito de Aplicación

- Industria ligera
- Mantenimiento y reparación
- Ranchos y granjas.

### Application Range

- Light industry
- Maintenance and reparation
- Farms and ranches.



### ES - Principales características

- Máxima capacidad de corte.
- Conexión 1 ph 230  $\pm$ 10%.
- Arco piloto.
- Menor consumo de aire.
- Antorcha sustituible.

### EN - Main features

- Maximun cutting capacity.
- Conexion 1ph 230+/-10%.
- Pilot arc.
- Lower air consumption.
- Replaceable torch.
- Light industry, maintainace and reparation, hobby, farms and ranches.

### Características técnicas Technical Characteristics

<b>REF.</b>	14003
<b>Intensidad máxima</b> Maximun Intensity	<b>40A</b>
<b>Rendimiento</b> Duty Cycle	<b>20° 70%</b> <b>40° 60%</b>
<b>Rango de regulación</b> Regulation range	<b>10-40A</b>
<b>Conexión</b> Supply voltage	<b>230V <math>\pm</math> 10%</b>
<b>Consumo</b> Power consumption	<b>6,5 Kva</b>

<b>Flujo de aire</b> Air flow	<b>20 l/min</b>
<b>Presión de aire</b> Air pressure	<b>3,5-4,5 bar</b>
<b>Dimensión / Dimensions</b>	<b>430 x 130 x 240 mm</b>
<b>Peso / Weight</b>	<b>4,9 kg</b>
<b>Capacidad de corte</b> Cutting capacity	<b>Acero / Steel 8 - 10 mm</b> <b>Inoxidable / Stainless 8 - 10 mm</b> <b>Aluminio / Aluminium 6 - 8 mm</b>

# SolCUT 60

## SOLCUT - 60 3PH-400V

PLASMA

SOLCUT 40

SOLCUT 60

### Ámbito de Aplicación

- Aplicación industrial
- construcción pesada
- Plantas petroquímicas
- Construcción naval
- Automoción.

### Application Range

- Industrial application
- Power construction plants
- Petrochemical plants
- Shipyards
- Car bodywork.



### ES - Principales características

- Máxima capacidad de corte.
- Conexión 3 ~ 400V  $\pm 10\%$ .
- Arco piloto.
- Menor consumo de aire.
- Antorcha sustituible.

### EN - Main features

- Maximun cutting capacity.
- Conexion 3 ~ 400V  $\pm 10\%$
- Pilot arc.
- Lower air consumption.
- Replaceable torch.

#### Características técnicas Technical Characteristics

REF.	14009
<b>Intensidad máxima</b> Maximun Intensity	<b>60A</b>
<b>Rendimiento</b> Duty Cycle	<b>20° 70%</b> <b>40° 60%</b>
<b>Rango de regulación</b> Regulation range	<b>10-60A</b>
<b>Conexión</b> Supply voltage	<b>380V <math>\pm 10\%</math></b>
<b>Consumo</b> Power consumption	<b>10 Kva</b>

<b>Flujo de aire</b> Air flow	<b>150 l/min</b>
<b>Presión de aire</b> Air pressure	<b>5-10 bar</b>
<b>Dimensión / Dimensions</b>	<b>605 x 400 x 280 mm</b>
<b>Peso / Weight</b>	<b>29 kg</b>
<b>Capacidad de corte</b> Cutting capacity	<b>Acero / Steel 20 - 25 mm</b> <b>Inoxidable / Stainless 18 - 22 mm</b> <b>Aluminio / Aluminium 14 - 18 mm</b>



# Antorchas MIG SX

## Torches MIG SX

**1** Consumibles de máxima calidad.  
Maximum quality consumables.

**2** Diseño ergonómico garantizando prestaciones y durabilidad, sin renunciar a aspectos tan importantes como el peso y la funcionalidad.

Ergonomic design guaranteeing performance and durability, without renouncing aspects as important as weight and functionality.

**3** Punto de rotación en la base de la empuñadura, facilitando los movimientos de la muñeca.  
Rotation point at the base of the handle, facilitating the movements of the wrist.

**4** Sistema de Cable hiperflexible.  
Hyperflexible cable system.

**5** Soporte de cable posterior.  
Support of the rear cable.

**6** Euroconector de calidad según norma EN 60974-7.  
Euro connector with the quality standard EN 60974-7.



**SX-15**

180A CO<sub>2</sub>, 150A mix.gas,  
EN60974-7 @ 60%. Ø 0,6 - 1,0 mm



	REF.
<b>3M</b>	56031

**SX-25**

230A CO<sub>2</sub>, 200A mix.gas,  
EN60974-7 @ 60%. Ø 0,6 - 1,2 mm



	REF.
<b>4M</b>	56032
<b>3M ALU</b>	56052

**SX-36**

300A CO<sub>2</sub>, 270A mix.gas,  
EN60974-7 @ 60%. Ø 0,8 - 1,6 mm





	REF.
<b>4M</b>	56033
<b>3M ALU</b>	56077

**SX-501**

550A CO<sub>2</sub>, 500A mix.gas,  
EN60974-7 @ 60%. Ø 0,8 - 1,6 mm

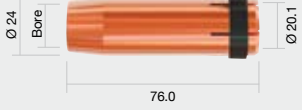

	REF.
<b>4M</b>	56075
<b>3M ALU</b>	56078

<b>Toberas</b> Nozzle		Descripción Description	Ref.	Embalaje Packing	U. Embalaje U. Packing
 <p>Ø 18.0 Bore Ø 12.15 53.0</p>	*Toberas / *Nozzle				
	SX 15	05936	Blister	2	
 <p>Ø 21.5 Bore Ø 15.0 57.5</p>	*Toberas / *Nozzle				
	SX 25	05937	Blister	2	
 <p>Ø 24 Bore Ø 20.1 76.0</p>	*Toberas / *Nozzle				
	SX 36	05938	Blister	2	

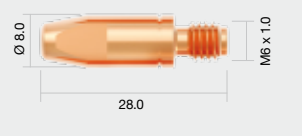
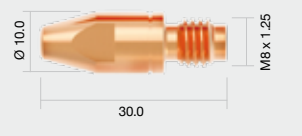
<b>Puntas contacto</b> Contact tips		Descripción Description	Ref.	Embalaje Packing	U. Embalaje U. Packing
 <p>Ø 6.0 25.0 M6 x 1.0</p>	*Puntas contacto / *Contact tips				
	M6 Ø 0,6 mm	56009	Blister	10	
	M6 Ø 0,8 mm	56010	Blister	10	
 <p>Ø 8.0 28.0 M6 x 1.0</p>	*Puntas contacto / *Contact tips				
	M6 Ø 0,8 mm	56028	Blister	10	
	M6 Ø 1,0 mm	56014	Blister	10	
 <p>Ø 10.0 30.0 M8 x 1.25</p>	*Puntas contacto / *Contact tips				
	M8 Ø 0,8 mm	06345	Blister	10	
	M8 Ø 1,0 mm	06346	Blister	10	
		M8 Ø 1,2 mm	06347	Blister	10

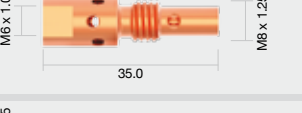
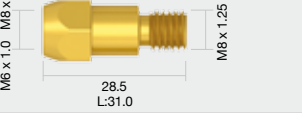
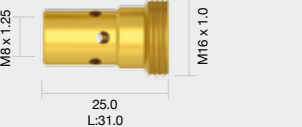
<b>Portatubo</b> Tip adaptors		Descripción Description	Ref.	Embalaje Packing	U. Embalaje U. Packing
 <p>M6 x 1.0 42.0 M8 x 1.0-L</p>	*Portatubo / *Tip adaptors				
	SX 15	05939	Blister	2	
 <p>M6 x 1.0 35.0 M8 x 1.25</p>	*Portatubo / *Tip adaptors				
	SX 25	05940	Blister	2	
 <p>M6 x 1.0 M8 x 1.25 28.5 L:31.0 M8 x 1.25</p>	*Portatubo / *Tip adaptors				
	SX 36	05941	Blister	2	
 <p>M8 x 1.25 25.0 L:31.0 M16 x 1.0</p>	*Portatubo / *Tip adaptors				
	SX 501	05942	Blister	2	



**Difusores**  
Diffusers



Descripción Description	Ref.	Embalaje Packing	U. Embalaje U. Packing
*Difusores / *Diffusers			
SX 36	05943	Blister	2



*Difusores / *Diffusers			
SX 501	05944	Blister	2

**Muelles**  
Nozzle tip spring



Descripción Description	Ref.	Embalaje Packing	U. Embalaje U. Packing
*Muelle tobera / *Nozzle tip spring			
SX15	56060	Bolsa / Bag	1
*Muelle tobera / *Nozzle tip spring			
SX25	56061	Bolsa / Bag	1

**Sirgas**  
Liners

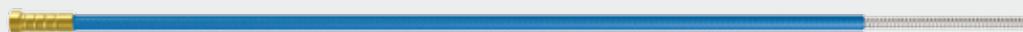

Descripción Description	Ref.	Embalaje Packing	U. Embalaje U. Packing
Sirga acero azul / Blue steel liner			
4 m Ø 0,6-0,8	56065	Bolsa / Bag	1



Sirga acero roja / Red steel liner			
4 m Ø 1,0 - 1,2	56064	Bolsa / Bag	1

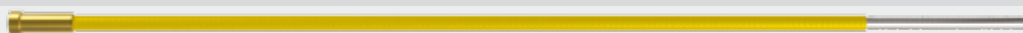

Sirga acero amarilla / Yellow steel liner			
4 m Ø1,2-1,6	56058	Bolsa / Bag	1

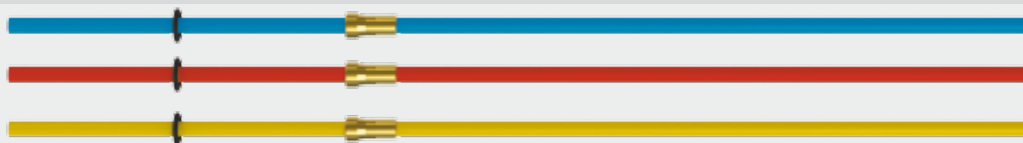

Sirga teflón azul / Blue teflon liner			
4 m Ø 0,6-0,8	56068	Bolsa / Bag	1

Sirga teflón roja / Red teflon liner			
4 m Ø1-1,2	56066	Bolsa / Bag	1

Sirga acero amarilla / Yellow teflon liner			
4 m Ø1,2-1,6	56067	Bolsa / Bag	1

**Sprays**  
Sprays



Descripción Description	Ref.	Embalaje Packing	U. Embalaje U. Packing
Spray Anti oxidante zincante / Anti-oxidizing zinc spray	06113	Caja / Box	12

# Antorchas TIG

## Torches TIG

- 1** Accesorios consumibles standard  
Standard consumable accessories
- 2** Cuello flexible  
Flexible neck
- 3** Empuñadura ergonomica  
Ergonomic handle
- 4** Cuatro opciones de Pulsador: Valvula, Pulsador Simple, Doble pulsador, Potenciómetro.  
Four button options: valve, single button, double button, potentiometer.
- 5** Punto de rotación en la base de la empuñadura, facilitando los movimientos de la muñeca.  
Rotation point at the base of the handle, facilitating the movements of the wrist.

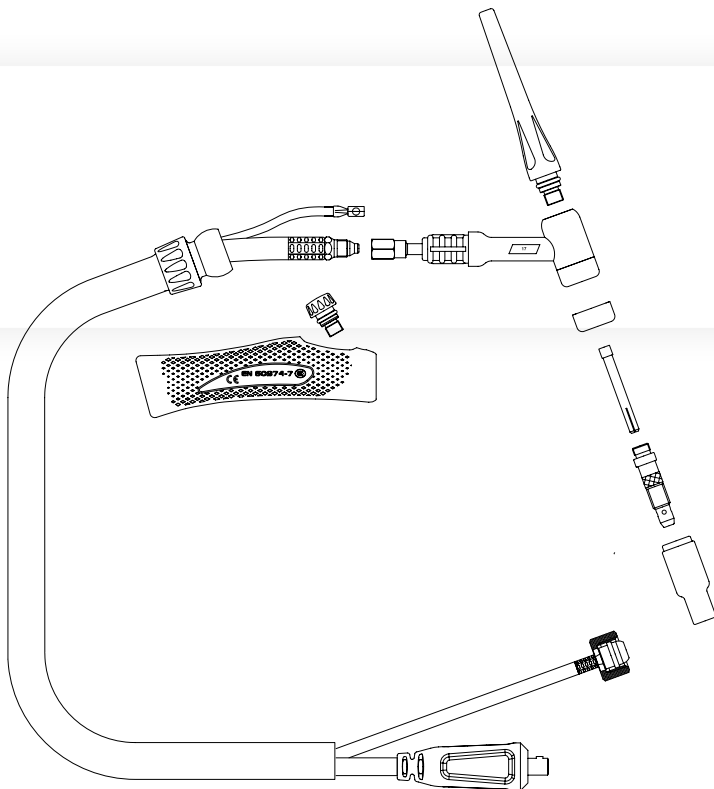

**SR-17V**

150A DC, 105A AC @ 35%



	REF.	CONN.
4M	06024	10/25 mm
	06031	35/50 mm

**SR-26V**

180A DC, 125A AC @ 35%

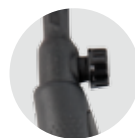

	REF.	CONN.
4M	06132	35/50 mm

**SR-17**

150A DC, 105A AC @ 35%



	REF.	CONN.
4M	06145	10/25 mm
	06168	35/50 mm
8M	06161	10/25 mm
	06162	35/50 mm

**SR-26**

180A DC, 125A AC @ 35%



	REF.	CONN.
4M	06029	35/50 mm

**SR-18W**

380A DC, 270A AC @ 100% duty cycle



	REF.	CONN.
4M	56076	35/50 mm

### Toberas cerámica Ceramic nozzle tips



Descripción Description	Ref.	Embalaje Packing	U. Embalaje U. Packing
GR4 Ø6,5	06200	Blister	2
GR5 Ø8,0	06343	Blister	2
GR6 Ø9,5	06201	Blister	2
GR7 Ø11,0	06344	Blister	2
GR8 Ø12,5	06202	Blister	2

### Difusores gas Gas Diffusers



Descripción Description	Ref.	Embalaje Packing	U. Embalaje U. Packing
Ø1,0 mm	06203	Blister	2
Ø1,6 mm	06244	Blister	2
Ø2,0 mm	06245	Blister	2
Ø2,4 mm	06246	Blister	2
Ø3,2 mm	06247	Blister	2
Ø4,0 mm	06204	Blister	2

### Portaelectrodos tungsteno Tungsten electrode holder

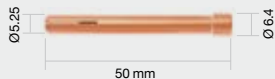

Descripción Description	Ref.	Embalaje Packing	U. Embalaje U. Packing
Ø1,0 mm	06220	Blister	2
Ø1,6 mm	06240	Blister	2
Ø2,0 mm	06241	Blister	2
Ø2,4 mm	06242	Blister	2
Ø3,2 mm	06243	Blister	2
Ø4,0 mm	06221	Blister	2

### Tapón Cap



Descripción Description	Ref.	Embalaje Packing	U. Embalaje U. Packing
Tapón largo/ Long cap	06085	Bolsa/ Bag	1
Tapón corto/ Short cap	06119	Bolsa/ Bag	1

Embalaje / Packing : Blister



## Electrodos de Tungsteno Tungsten Electrodes

Tungsteno Puro- VERDE  
Pure Tungsten - GREEN

2% Torio- Rojo  
2% Thorium - RED

2% Cerio- Gris  
2% Cerium - GREY

1,5% Lanthano - DORADO  
1,5% Lanthanum - GOLDEN

Ø	AC		AC / DC		DC	
	Ref.		Ref.		Ref.	
1,0 mm	06207		06205	06209	06214	
1,6 mm	06150		06065	06177	06215	
2,0 mm	06151		06066	06210	06216	
2,4 mm	06152		06067	06211	06217	
3,2 mm	06153		06149	06212	06218	
4,0 mm	06208		06206	06213	06219	

# Pinzas Portaelectrodos

## Electrode holder clamps

### Portaelectrodos Electrode holder



Descripción Description Ref.	Tipo Type	Amp	x%	mm. max	elec. max	Embalaje Packing	U. Embalaje U.Packing
------------------------------------	--------------	-----	----	---------	-----------	---------------------	--------------------------

Pinza Portaelectrodo / Electrode Holder

06006	Abierta / Open	200A	35%	35 mm	4,00 mm	Blister	1
06005	Abierta / Open	300A	35%	50 mm	5,00 mm	Blister	1
06033	Abierta / Open	600A	35%	95 mm	6,30 mm	Blister	1



Pinza Portaelectrodo / Electrode holder

06669	Cerrada / Closed	300A	35%	50 mm	5,00 mm	Blister	1
06578	Cerrada / Closed	400A	35%	95 mm	6,30 mm	Blister	1

# Pinzas de masa

## Earth Clamps

### Pinzas masa Earth clamps



Ref.	Descripción Description	Tipo Type	Amp	x%	elec. max	Embalaje Packing	U. Embalaje U. Packing
------	----------------------------	--------------	-----	----	-----------	---------------------	---------------------------

06022		Chapa / Sheet metal	150A	35%	16 mm	Blister	1
-------	--	------------------------	------	-----	-------	---------	---



06037		Chapa / Sheet metal	200A	35%	35 mm	Blister	1
06038		Chapa / Sheet metal	400A	35%	70 mm	Blister	1

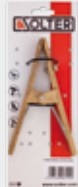

06023		Latón / Brass	200A	35%	35 mm	Blister	1
06129		Latón / Brass	400A	35%	70 mm	Blister	1



06159		Tornillo / Screw	500A	60%	95 mm	Blister	1
-------	--	------------------	------	-----	-------	---------	---



# Conectores Connectors

Dimension	Ref. 05947	Ref. 05948
<b>A</b>	Ø 9.0 mm	Ø 13.0 mm
<b>B</b>	Ø 25.0 mm	Ø 35.0 mm
<b>C</b>	14.0 A/F	21.0 A/F
<b>D</b>	Ø 9.2 mm	Ø 13.2 mm

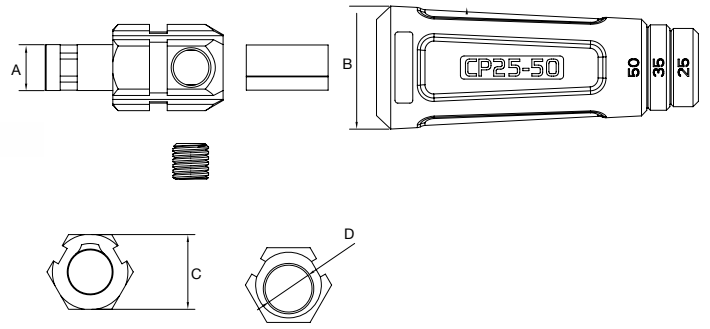

## Conector aereo macho Male air connectors

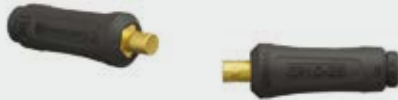

Ref.	Tipo Type	Embalaje Packing	U. Embalaje U. Packing
------	--------------	---------------------	---------------------------

05947	10-25 mm	Blister	2
-------	----------	---------	---

05948	35 - 50 mm	Blister	2
-------	------------	---------	---

Dimension	Ref. 05945	Ref. 05946
<b>A</b>	Ø 9.0 mm	Ø 13.0 mm
<b>B</b>	Ø 25.0 mm	Ø 35.0 mm
<b>C</b>	14.0 A/F	21.0 A/F
<b>D</b>	Ø 9.2 mm	Ø 13.2 mm

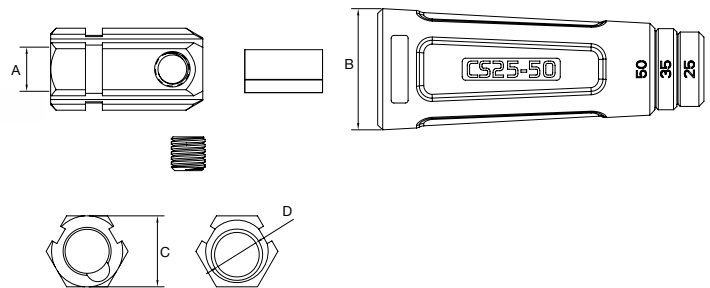

## Conector aereo hembra Female air connectors

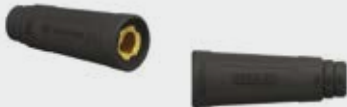

Ref.	Tipo Type	Embalaje Packing	U. Embalaje U. Packing
------	--------------	---------------------	---------------------------

05945	10-25 mm	Blister	2
-------	----------	---------	---

05946	35 - 50 mm	Blister	2
-------	------------	---------	---

Dimension	Ref. 06121	Ref. 06122
<b>A</b>	Ø 9.0 mm	Ø 13.0 mm
<b>B</b>	Ø 32	Ø 40
<b>C</b>	M8	M10
<b>D</b>	14.0 A/F	21.0 A/F
<b>E</b>	Ø 20.1 mm	Ø 28.2 mm
<b>F</b>	22.9 mm	31.0 mm

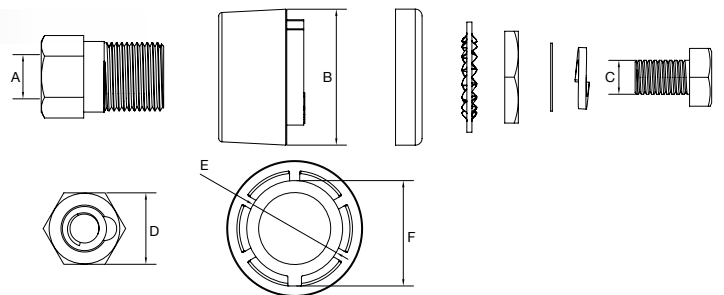

## Conectores DINSE fijos Fixed DINSE connectors



Ref.	Tipo Type	Embalaje Packing	U. Embalaje U. Packing
------	--------------	---------------------	---------------------------

06121	10-25 mm	Blister	2
-------	----------	---------	---

06122	35 - 50 mm	Blister	2
-------	------------	---------	---

# Conjuntos soldadura completos

## Complete Welding Kits

Cable soldadura Welding cable	Ref.	
	06010	1x16 mm <sup>2</sup> (m)
	06011	1x25 mm <sup>2</sup> (m)
	06039	1x35 mm <sup>2</sup> (m)
	06157	1x50 mm <sup>2</sup> (m)
	06158	1x70 mm <sup>2</sup> (m)

Conjuntos pinzas Cable sets	Ref.	Descripción Description	m x mm	mm	Amp.
	Conjunto pinza masa / Earth clamp kit				
	06123		2m x CU 16 mm	10-25 mm	200A
	06125		2m x CU 25 mm	35-50 mm	200A
	06148		3m x CU 25 mm	10-25 mm	200A
	06165		3m x CU 25 mm	35-50 mm	200A
	06114		3m x CU 35 mm	35-50 mm	400A
	06130		4m x CU 35 mm	35-50 mm	400A

	Ref.	Descripción Description	m x mm	mm	Amp.
	Conjunto Porta-electrodo / Electrode holder kit				
	06124		3m x CU 16 mm	10-25 mm	200A
	06009		3m x CU 25 mm	10-25 mm	200A
	06126		3m x CU 25 mm	35-50 mm	200A

Horno electrodos Oven electrodes	Ref.											
	06097	Horno electrodos / Oven electrodes *Con termostato e indicador de temperatura *With thermostat and temperature indicator										
	<table border="1"> <thead> <tr> <th>Conexión Tension Alimentation</th> <th>Potencia Power</th> <th>Capacidad Capacity</th> <th>Dimensiones Dimensions</th> <th>Peso Weight</th> </tr> </thead> <tbody> <tr> <td>230Vac +-15%</td> <td>300W</td> <td>10 Kg electrodos de 450 mm / 10 Kg electrodes de 450 mm</td> <td>620 x 200 x 180</td> <td>4 kg</td> </tr> </tbody> </table>		Conexión Tension Alimentation	Potencia Power	Capacidad Capacity	Dimensiones Dimensions	Peso Weight	230Vac +-15%	300W	10 Kg electrodos de 450 mm / 10 Kg electrodes de 450 mm	620 x 200 x 180	4 kg
	Conexión Tension Alimentation	Potencia Power	Capacidad Capacity	Dimensiones Dimensions	Peso Weight							
230Vac +-15%	300W	10 Kg electrodos de 450 mm / 10 Kg electrodes de 450 mm	620 x 200 x 180	4 kg								

Cepillos Brushes	Ref.	Descripción Description	Embalaje Packing	U. Embalaje U. Packing
	06019	Cepillo Doble-Púas Acero Double brush-steel teeth	Caja / Box	1
	06021	Cepillo-Piqueta acero Brush-pick ax	Caja / Box	1

Piquetas Pick Axes	Ref.	Descripción Description	Embalaje Packing	U. Embalaje U. Packing
	06003	Piqueta Acero mango madera (1) Steel pick ax, wooden handle (1)	Caja / Box	1
	06004	Piqueta Metálica (2) Metal pick ax (2)	Caja / Box	1

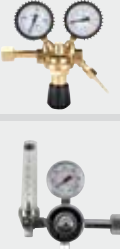
Manómetros ECO-PRO Manometers eCO-PRO	Ref.	
	56026	Manoreductor ECO ARG/CO2 200bar-32l/min salida 1/4" Pressure regulator ECO ARG/CO2 200bar-32l/min salida 1/4"
	56096	Manoreductor-rotámetro ECO ARG/CO2 200bar-32l/min salida 1/4" Pressure regulator-flowmeter ECO ARG/CO2 200bar 32l/min output 1/4"

# INVERKONTROL DI 230



## Protector para generador Power Generator Protector



### ES - Principales características

Protege contra subidas y bajadas de tensión. Ideal para conectar dispositivos electrónicos sensibles\* a fuentes de corriente inestables.

Generadores, alargaderas...

\*(con rango de funcionamiento de 160V 280V)

### EN - Main Features

It protects against voltage rises and drops. Ideal for connecting sensitive electronic devices\* to unstable power sources. Power generators, extensions...  
(with operating range of 160V 260V)

### Características técnicas Technical Characteristics

Ref. 04119	Di 230
<b>Tensión alimentación (vac)</b> Supply voltage (vac)	<b>230 1ph</b>
<b>Intensidad máx. (A)</b> Max. Intensity (A)	<b>30</b>
<b>Voltaje mín. de control (V)</b> Min. control voltage (V)	<b>160</b>
<b>Voltaje máx. De control (V)</b> Max. control voltage (V)	<b>280</b>
<b>Voltaje máx. (V)</b> Max. Voltaje (V)	<b>400 @ 20%</b>
<b>Frecuencia de trabajo (hz)</b> Work frequency (hz)	<b>50 / 60</b>
<b>Dimensiones (mm)</b> Dimensions (mm)	<b>175x125x90</b>
<b>Peso (kg) / Weight (kg)</b>	<b>1,1</b>



# Electrodos

## Electrodes BLISTER

Blister

RUTILO / RUTILE SO-6013



### ACERO - RUTILO E6013 STEEL - RUTILE E6013

Ref.	Diámetros mm Diameters mm	u./ blister
05905	1,60 x 300	35u
05965	2,00 x 300	35u
05966	2,50 x 350	30u
05967	3,25 x 350	20u
05968	4,00 x 350	12u

Blister

BASICO / BASIC SO-7018



### BASICO E7018 BASIC E7018

Ref.	Diámetros mm Diameters mm	u./ blister
05973	2,50 x 350	10u

Blister

INOXIDABLE / STAINLESS  
SO-316

### INOXIDABLE 316L-16 ROSTFREI 316L-16

05964	2,00 x 300	10u
05974	2,50 x 350	10u

Blister

FUNDICIÓN SO-NiFe-CI  
CAST IRON SO-NiFe-CI

### FUNDICION NiFe-CI CAST IRON NiFe-CI

05976	2,50 x 300	10u
-------	------------	-----

Blister

ALUMINIO SO-AISI  
ALUMINIUM SO-AISI

### ALUMINIO AL Si ALUMINIUM AL Si

05975	2,50 x 350	10u
-------	------------	-----

# Electrodos / Electrodes

## ACEROS AL CARBONO / MID STEEL

### ACERO-RUTILO GREAT PERFORMANCE

**SO-6013**

AWS: E 6013

DIN: E 42 A RC 11



Posiciones soldadura  
Welding positions

Diámetros mm Diameters mm	Ref.	Embalaje Packing	U.Paquete U. Packing
2,00 x 300	06533	Caja / Étui	365
2,5 x 350	06534	Caja / Étui	258
3,25 x 350	06535	Caja / Étui	168
4,00 x 350	06536	Caja / Étui	112

Análisi químico / Chemical analysis	% C	% Si	% Mn	% Mo
	0,07 %	0,35 %	0,35 %	0,00 %

- Utilización universal y fácil en todas las posiciones.
- Arco suave, pocas proyecciones.
- Aspecto del cordón de calidad.
- Construcciones navales, mecánica, cerrajería en general, calderería.

- \* Universal and easy use on all welding positions
- \* Smooth Arc, few spatters .
- \* Quality and nice seam.
- \* Shipbuilding , metal construction.