

THE PRO-BEAM GROUP

E-Beam and Coating Technologies



CONTRACT MANUFACTURING

We weld, harden, perforate and coat for companies and research facilities.

PLANT ENGINEERING

Customer-specific machines with intelligent automation solutions.

CUSTOMER SERVICE

From spare parts management to retrofitting.

LEGAL INFORMATION

Publisher

pro-beam GmbH & Co. KGaA
Zeppelinstraße 26
82205 Gilching
Germany
Telephone: +49 89 899 233-0
Fax: +49 89 899 233-11
info@pro-beam.com
www.pro-beam.com

Editing

Marketing
pro-beam GmbH & Co. KGaA

Concept & design

Im Neuland GmbH

Picture credits

pro-beam GmbH & Co. KGaA

Photographers: Bertram Bölkow,
Ines Escherich, Andreas Hackl

M.Style/fotolia.com (P. 09)
m.mphoto/Shutterstock (P. 22/23)
ESA/ATG medialab (P. 26/27)
ESA - D. Ducros (P. 29 top)
ESO/H.H.Heyer (P. 29 center)
ITER Organization (P. 29 bottom)
Anton Violin/Shutterstock.com (P. 30/31)
thka/Shutterstock.com (P. 34/35)
Marco photo/Shutterstock.com (P. 38/39)
asharkyu/Shutterstock.com (P. 56/57)
elektronik-zeit/fotolia.com (P. 64)

E-Beam and Coating for Excellence.

We at pro-beam are market leaders in the area of electron beam technology and are internationally renowned for our thin film process. With more than 45 years' experience and know-how in the areas of welding, perforating, hardening and coating, we see ourselves as your development partner and fully understand the needs and requirements of the automotive, semiconductor and aerospace industries, as well as large-scale research projects.

Our mission is to actively work with our customers to build a successful future together with the help of high-tech processes. In order to achieve this goal, we have committed to the guiding principle of *creating the future together*.

**OUR MISSION IS TO
ACTIVELY WORK WITH
OUR CUSTOMERS TO BUILD
A SUCCESSFUL FUTURE
TOGETHER SUPPORTED BY
HIGH-TECH PROCESSES.**

For us, this also means, on the one hand, providing our employees – from our trainees to our professionals – with the best development opportunities and a modern work environment. Furthermore, this approach also includes the goal of providing companies and institutes with ultra-modern products and services, and developing innovations for the major issues of tomorrow.

For this reason, we are working hard on the topics of the future, such as electromobility, at our headquarters in Gilching, which houses our development and innovation center. In addition, we are also researching the field of additive manufacturing where we see the opportunity to position the electron beam in a completely new environment.

We are convinced that our technology offers economic advantages. That's why we look forward to being able to help you design your future, whether it be within the scope of contract manufacturing, system development and construction or via our customer service.

Nicolas Frhr. von Wolff
Dipl.-Wirt.-Ing.
CEO, pro-beam Group



Dr. Thorsten Löwer
CTO, pro-beam Group



Contents

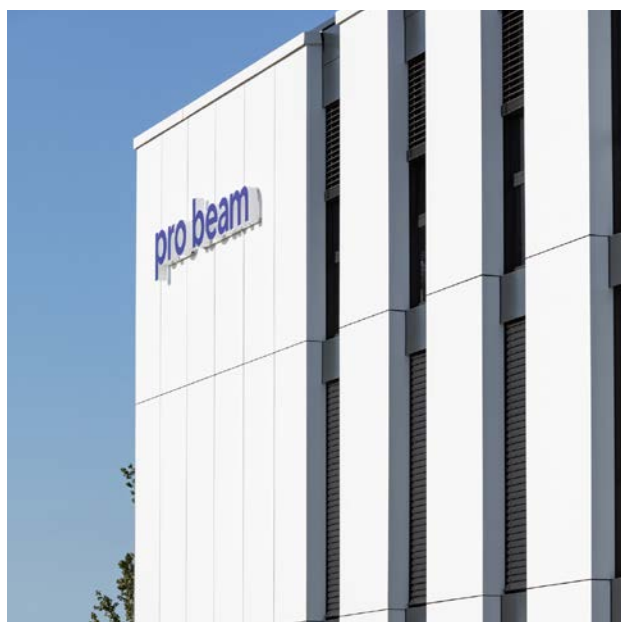

7 About pro-beam

- 8 pro-beam at a glance
- 10 The pro-beam Group
- 12 Milestones in the company history
- 14 Our service portfolio
- 15 Why pro-beam?
- 16 The technology behind the electron beam

19 Contract manufacturing

- 20 pro-beam contract manufacturing
- 22 Welding industry
- 26 Big science welding
- 30 Hardening
- 34 Perforation
- 38 Coating

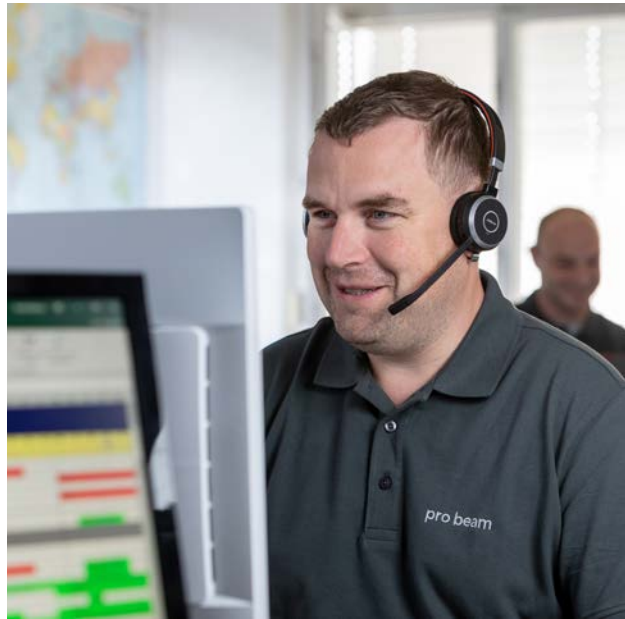

43

Plant engineering

- 46 pro-beam plant engineering
- 48 Our systems at a glance
- 50 System modules
- 52 Digitization and automation

55

Customer service

63

New technology





About pro-beam

- 8 PRO-BEAM AT A GLANCE
- 10 THE PRO-BEAM GROUP
- 12 MILESTONES IN THE COMPANY HISTORY
- 14 OUR SERVICE PORTFOLIO
- 15 WHY PRO-BEAM?
- 16 THE TECHNOLOGY BEHIND THE ELECTRON BEAM

Who we are



pro-beam at a glance

The pro-beam Group is a global leader in the field of electron beam and laser technology. We offer integrated solutions for electron beam welding, perforation and hardening, as well as for surface finishing. Our products and services are used worldwide, and they enable safe flights to outer space, equip millions of cars and are also part of spectacular, big science projects. In addition, we are also working on future issues such as e-mobility.

We set high standards for ourselves, and precision and accuracy characterize our thoughts and actions. Moreover, one thing is vital to our success: at pro-beam, we focus on our employees. We challenge and encourage each and every one of our colleagues and support individual development. This is how we will design the future together.



430+

employees



5

locations worldwide



45+

years of experience



36

patents



60+

sales revenue
(in million €)



40

countries worldwide

The pro-beam Group

Pro-beam is an internationally operating company with locations in Europe, Asia and America. The group activities are managed from the company headquarters in Gilching near Munich. The headquarters site also functions as a development and innovation center for both existing and new technologies. A global sales and service network as well as numerous sales representatives support our customers in over 40 countries.

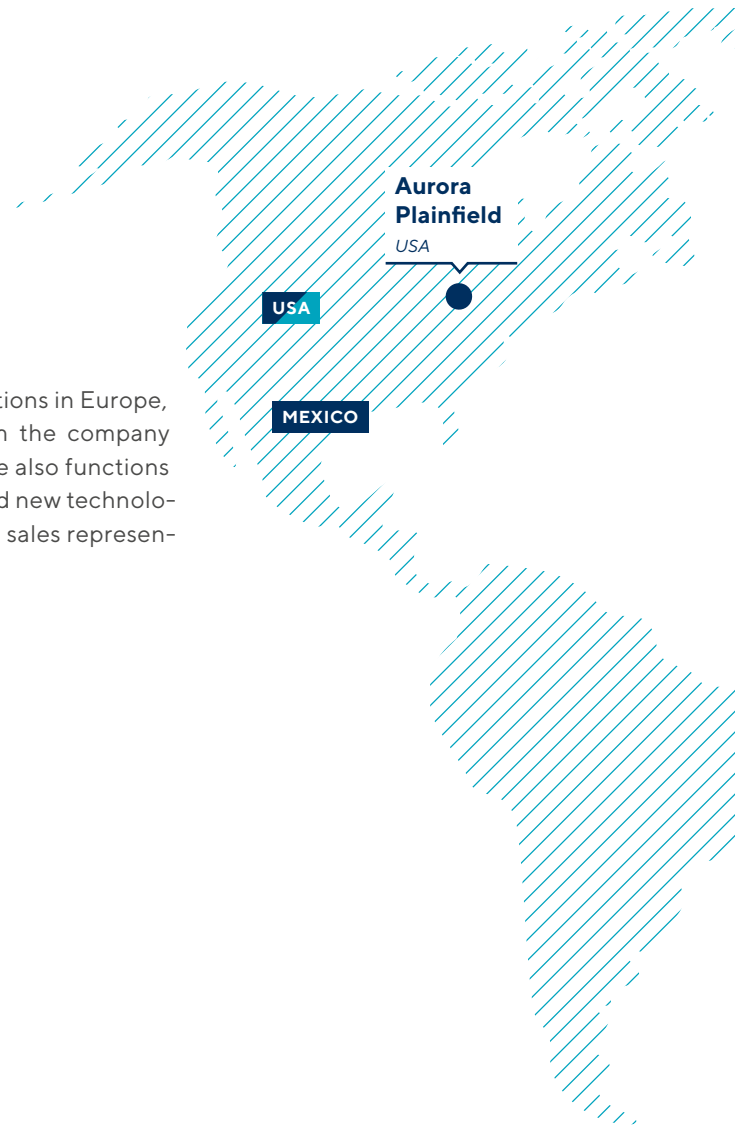

GERMANY



Headquarters in Gilching

ADMINISTRATION
CONTRACT MANUFACTURING
COATING CENTER
PERFORATION CENTER
INNOVATION AND DEVELOPMENT
CUSTOMER SERVICE



Neukirchen*

PLANT ENGINEERING
CUSTOMER SERVICE



Burg

CONTRACT MANUFACTURING

*Stollberg from 2020

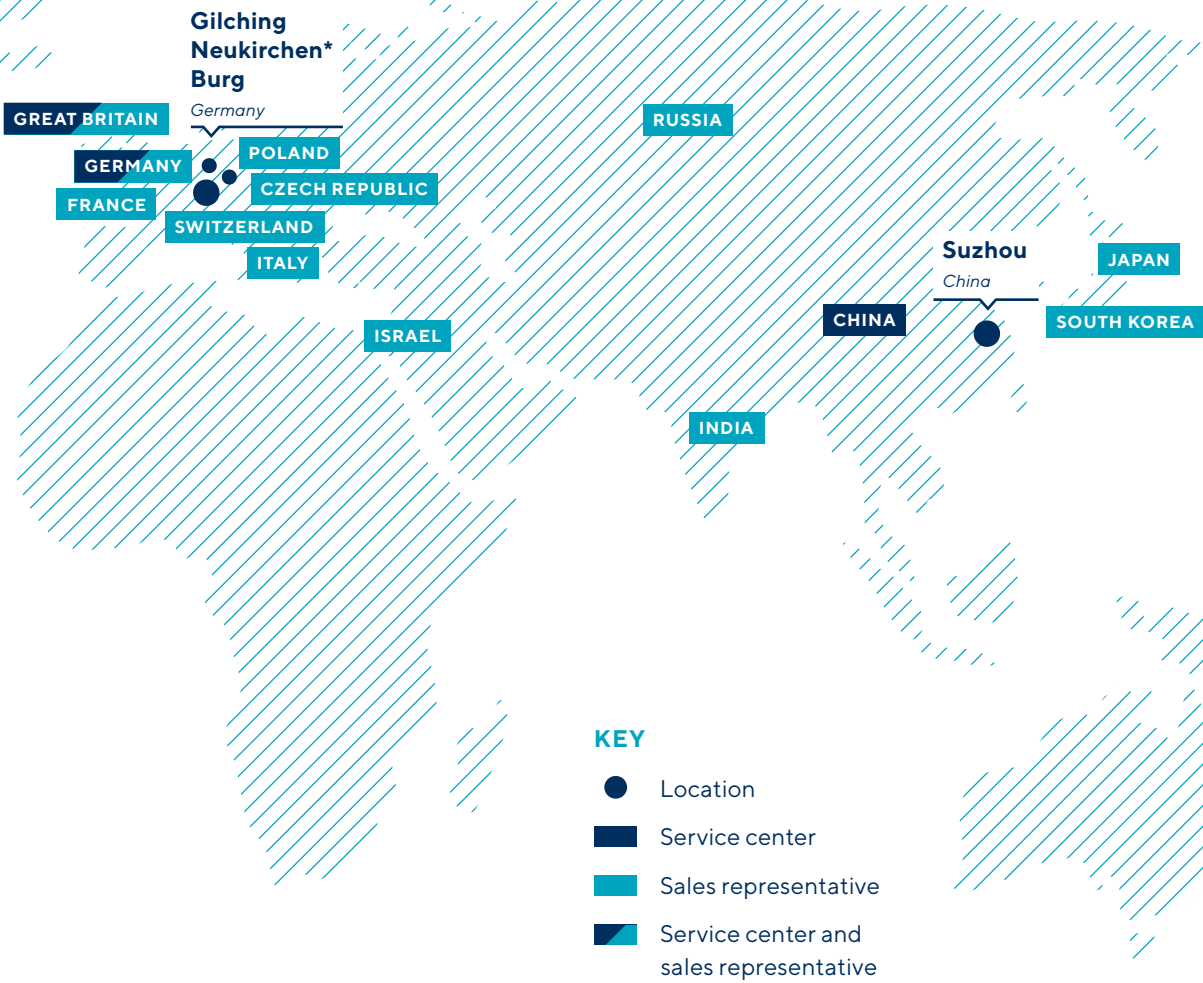

USA



Aurora

CONTRACT MANUFACTURING
PLANT ENGINEERING SALES
CUSTOMER SERVICE

CHINA



Suzhou

CONTRACT MANUFACTURING
PLANT ENGINEERING SALES
CUSTOMER SERVICE

Milestones in the company history



1974

Dr. h. c. Dietrich Freiherr von Dobeneck founded the pro-beam company in Munich in 1974

1995

Founding of the coating segment

2001

Participation in the ITER large-scale research project



1986

Construction of the first pro-beam machines for internal use

1999

Launch of the system business with the founding of pro-beam systems in Neukirchen



2003

Founding of the Burg plant (contract manufacturing)

2005

Founding of pro-beam China

2004

Commissioning of the largest civilian welding system in the world

2016

Founding of pro-beam USA

2018

Company headquarters moved from Planegg to Gilching



2020

Completion of the new company building for pro-beam systems in Stollberg

2019

pro-beam employs over 400 people for the first time



Our service portfolio

We offer solutions for electron beam welding, drilling and hardening, along with surface coating solutions. Depending on their requirements, our customers can choose between contract manufacturing by pro-beam or their

own customer-specific system supplied by pro-beam — with us as your competent development partner for efficient production processes. In addition, we also offer fast and flexible customer service.

Contract manufacturing

Modern machinery and extensive process engineering know-how lay the foundation for our contract manufacturing services. Customers benefit from the following processes:

- **Electron beam welding**
- **Electron beam perforation**
- **Electron beam hardening**
- **Coating with diadur®DLC**

Plant engineering

We develop and manufacture customer-specific machines, intelligent automation solutions and turnkey solutions:

- **Systems for electron beam welding**
- **Systems for electron beam perforation**
- **Systems for electron beam hardening**
- **UMH heating systems**
- **Turnkey solutions**

Customer service

We want our customers to benefit from the efficiency and precision of electron beam technology without restrictions. That's why we have expanded our scope of services:

- **Maintenance**
- **Update**
- **Retrofit Core**
- **Training and Consulting**
- **Repair**
- **Upgrade**
- **Retrofit Extended**

Why pro-beam?

pro-beam systems and services enhance products and simplify manufacturing processes – anywhere in the world and in many different industries.



OUR EXPERIENCE – YOUR ADDED VALUE

- ✓ A competent partner at your side: from development, contract manufacturing, plant engineering to customer service
- ✓ Over 45 years of experience for your business success
- ✓ Powerful, high-performance system technology customized for you
- ✓ With our agile and efficient infrastructure, we focus on your needs while ensuring flexibility
- ✓ Know-how of single and series production processes: verifiable and reliable
- ✓ Certificates and accreditations for your industry
- ✓ Always keeping a finger on the pulse of current developments due to a strong international network with associations, research institutes and universities
- ✓ Close at hand due to representatives worldwide (Europe, Asia, America)



The technology behind the electron beam

Electrons are fundamental building blocks of matter. In solid objects, they are responsible for the transport of electrical charges and thus for the flow of current. In electron beam welding, perforation or hardening, a heated cathode first generates a cloud of free electrons. As a general rule, electrons are permanently bound to atoms. However, they can be released from the solid's lattice bond when energy is supplied. The electrons are then accelerated via an electric field to the anode. Electromagnetic lenses form a focused beam composed of the free electrons. As a result, they reach a speed between one and two thirds of the speed of light. Since the electron beam can be diverted magnetically, it can be precisely controlled and is able to implement even complex tasks. The entire process takes place in a vacuum.

When the electrons hit the matter during electron beam welding, they give off pinpoint heat and the surrounding material remains cold to the greatest possible extent. For energy densities of over 10^7 W/cm², the melted substance in the center eventually vaporizes. This results in a capillary, which is held open by the vaporized material, surrounded by liquid material and can

be extended over the entire material thickness. Due to the movement of this vapor capillary through the workpiece, the molten mass can flow together behind the capillary and solidify, thus leading to the bonding in the workpiece.

Perforation using an electron beam functions along the same principle. However, underlays susceptible to vaporization are used, which drive the molten mass explosively out of the capillary, resulting in holes or slots.

For hardening, the zoned surface to be processed is briefly heated with the electron beam. The area of the component that remains cold subsequently leads to self-quenching.

In general, the work carried out in the vacuum enables clean and high-quality workpieces. There are no processing residuals and the components can be used immediately without any post-processing. The use of gate shuttle modules for welding or hardening tasks allows for loading and unloading while the process is running – for effective and efficient work.



The generator is the heart of the electron beam system.

ADVANTAGES OF E-BEAM TECHNOLOGY FOR COMPLEX WELDING, PERFORATION OR HARDENING APPLICATIONS:



Easy automation

The electron beam operates 100% digitally. This means that processes are easy to automate and results can be reproduced at any time. In addition, users profit from seamless process monitoring and quality control, which are fully traceable.



Versatility

Almost all metallic materials can be processed using electron beam technology, from case-hardened steels, aluminum and aluminum alloys to titanium. Electron beam welding ensures reliable, stable metal compounds for high load-bearing components.



High weld penetration depths

Electron beam technology is characterized by weld penetration depths of over 150 mm. This deep welding effect results in narrow as well as parallel weld seams. Thus the electron beam is significantly superior to conventional welding processes and offers even more advantages than laser technology.



Maximum precision with minimum stress

Thanks to focused heat input into the material, electron beam technology allows almost warp-free welding – this is also one of the most warp-free welding processes. The mechanical and technological properties of the material remain almost unchanged.



High flexibility starting with process design

The electron beam can be formed and influenced intelligently using magnetic fields. For this reason, you can create components with almost any geometries even as early as the design phase. This increases flexibility in process design and delivers cost savings.



Ideally suited for large unit quantities

Electron beam technology is perfect for high volume manufacturing due to its simple work preparation, high speed and single pass processing. Even the multiple process technique, for example, in which three points are welded simultaneously, ensures maximum productivity.



Low operating costs

Working with the electron beam takes place in a vacuum. No auxiliary and operating materials are required, e.g. process gases or additional materials.





Contract manufacturing

20 PRO-BEAM CONTRACT MANUFACTURING

22 WELDING INDUSTRY

26 BIG SCIENCE WELDING

30 HARDENING

34 PERFORATION

38 COATING

pro-beam contract manufacturing

The world's largest civilian welding system is located at our subsidiary in Burg.





We use electron beam welding, perforation and hardening within the scope of our contract manufacturing service. This ranges from components measuring several meters weighing 100 tons to components weighing only a few grams. In addition, we also coat tools and components with the help of our specially developed diadur®DLC coating to protect them from wear.

At the same time, pro-beam meets the strict requirements of numerous industry norms and standards. Moreover, companies and customers from the science and research segments also benefit from modern machinery with an agile and efficient infrastructure. The systems are highly available and well suited for large-scale and small-scale production, as well as for single unit productions, such as the world's largest civilian welding system at the Burg site with a chamber volume of 600 m³.

However, for optimal results, it takes more than just modern process engineering. That's why we, as a development partner, understand the need to take care of the customer by means of qualified employees and experienced project managers from the very beginning. We also provide advice for component design, material selection and cost-effective production. In this way, we achieve a level of quality that is a cut above.

**FOR OPTIMAL RESULTS,
IT TAKES MORE THAN
JUST MODERN PROCESS
ENGINEERING.**

In order to give our customers a significant competitive advantage in tomorrow's world, we continuously develop our manufacturing processes, test the limits of technology and create new processes.



OTHER ADVANTAGES OF CONTRACT MANUFACTURING

- + Flexibility regarding unit quantities and component size
- + No need for expensive machine investments
- + Seamless integration with your production flow
- + Expert know-how
- + Supply chain management
- + Easy mastery of order peaks



Welding industry

22

Welding industry
Contract manufacturing

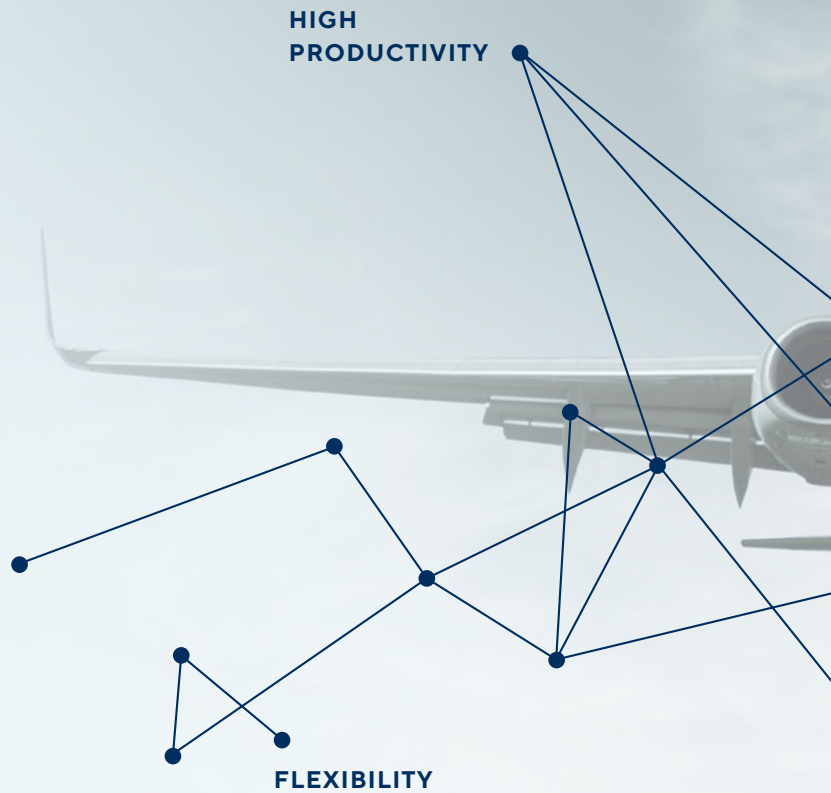

Industries

- + Aerospace industry
- + Automotive
- + E-mobility
- + Mechanical and plant engineering
- + Energy
- + Semiconductor industry
- + Medical engineering
- + Sensor technology
- + Research

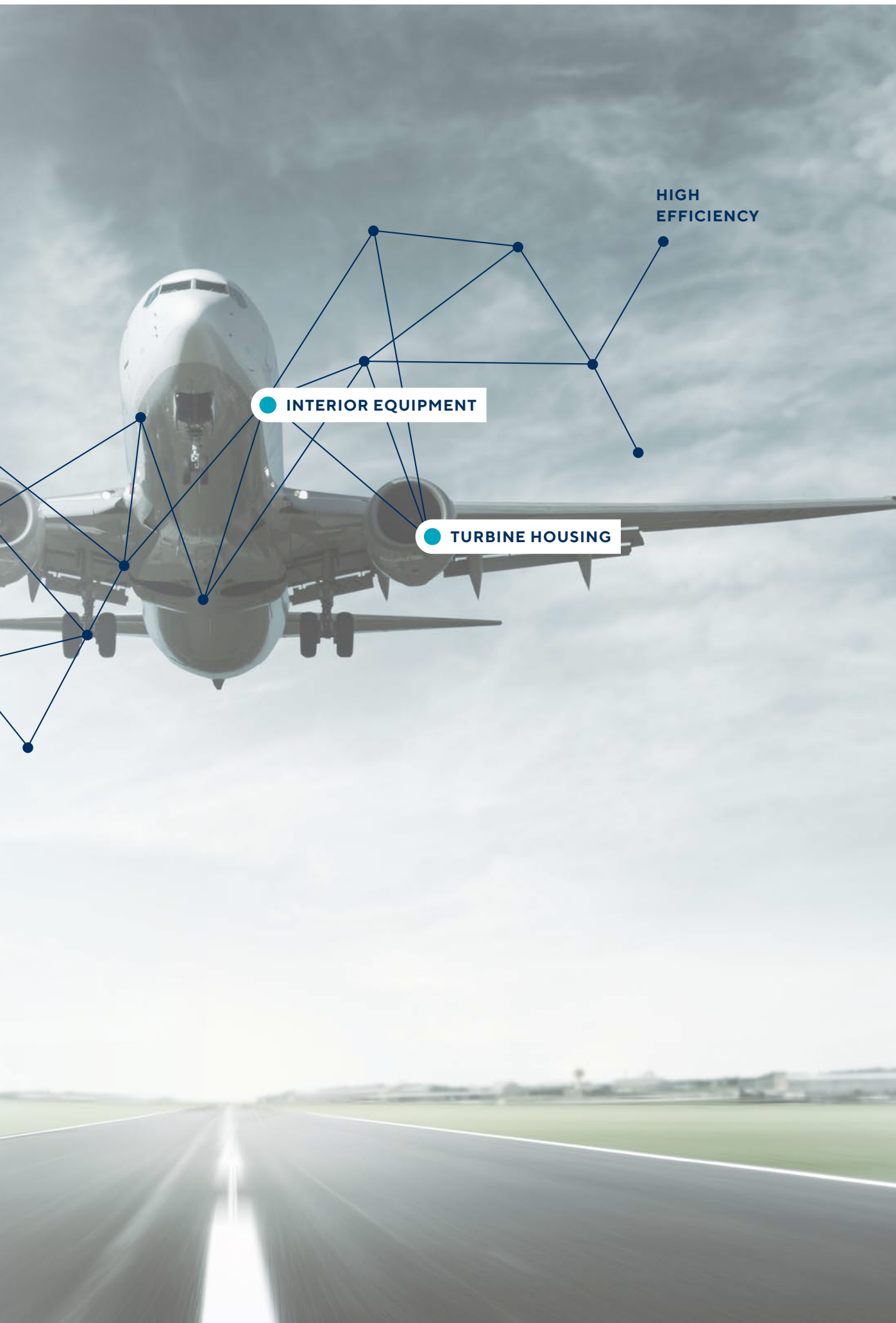

● INTERIOR EQUIPMENT

● TURBINE HOUSING

HIGH
EFFICIENCY

Welding in the industrial area

Standard metals, challenging mechanical materials, difficult-to-weld metals: where other welding processes reach their limitations, the electron beam ensures optimum results – even for complex structures or high load-bearing components. In addition, wall thicknesses of more than 150 mm and components with sen-

sitive internal parts, such as sensors, can also be joined. The welding process in a vacuum is an efficient and economical solution both for industries demanding high precision, as well as those that are highly automated with short cycle times.

THE ADVANTAGES OF THE ELECTRON BEAM IN INDUSTRIAL ENVIRONMENTS



Easy automation

Due to the fact that the electron beam operates 100% digitally, joining processes can be easily automated and monitored, welding results are reproducible at any time and mechanical properties remain intact.



Flexibility

The electron beam can be made into any shape using magnetic fields to enable the welding of geometrically complex components. This gives engineers more freedom when it comes to process design and construction.



High efficiency

The process delivers deep, narrow and parallel seams. With simple seam preparation and a weld penetration depth of over 150 mm, electron beam joining is far superior to other thermal processes. This eliminates the need for multiple layer welding or additional material. Oversize is significantly reduced due to near-net-shape processing.



Maximum precision

Electron beam welding achieves precise results with minimum stress and warping of workpieces.



Low operating costs

Working with the electron beam takes place in a vacuum. No auxiliary and operating materials required, e.g. process gases or additional materials.



Ideally suited for large unit quantities

Electron beam technology is well suited for the manufacture of large unit quantities due to precise seam preparation and high welding speed.



Cleaner workpieces

Processing in a vacuum results in high-quality weld seams and clean workpieces.

Applications

INDUSTRY: Automotive
COMPONENT: Flap plate for turbo chargers
PROCESSING: Mass production welding of very hard-to-weld materials



INDUSTRY: Automotive
COMPONENT: Flap plate for turbo chargers
MATERIAL: Inconel 713
PROCESSING: Mass production welding of very hard-to-weld materials



INDUSTRY: Automotive
COMPONENT: Piston rod
PROCESSING: Seam tracking, preheating and stitching using electron beam technology, welding, cosmetic seam, engraving using electron beam technology (component number)

Big science welding

26

Big science welding
Contract manufacturing

Projects

- + Xenon
- + Dresdyn
- + Solar Orbiter
- + Very Large Telescope
- + ITER

MAXIMUM PRECISION

EFFICIENT MANUFACTURING

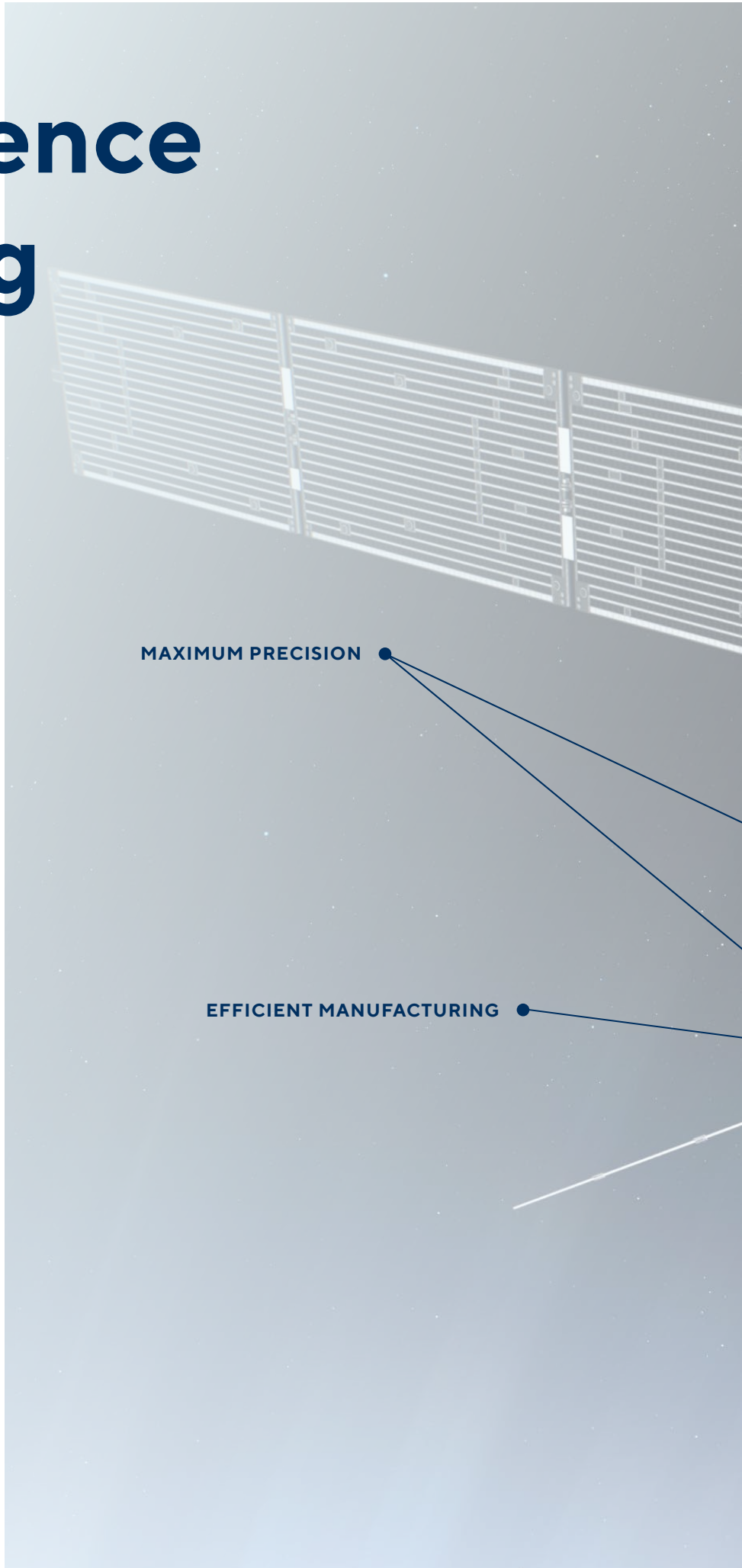

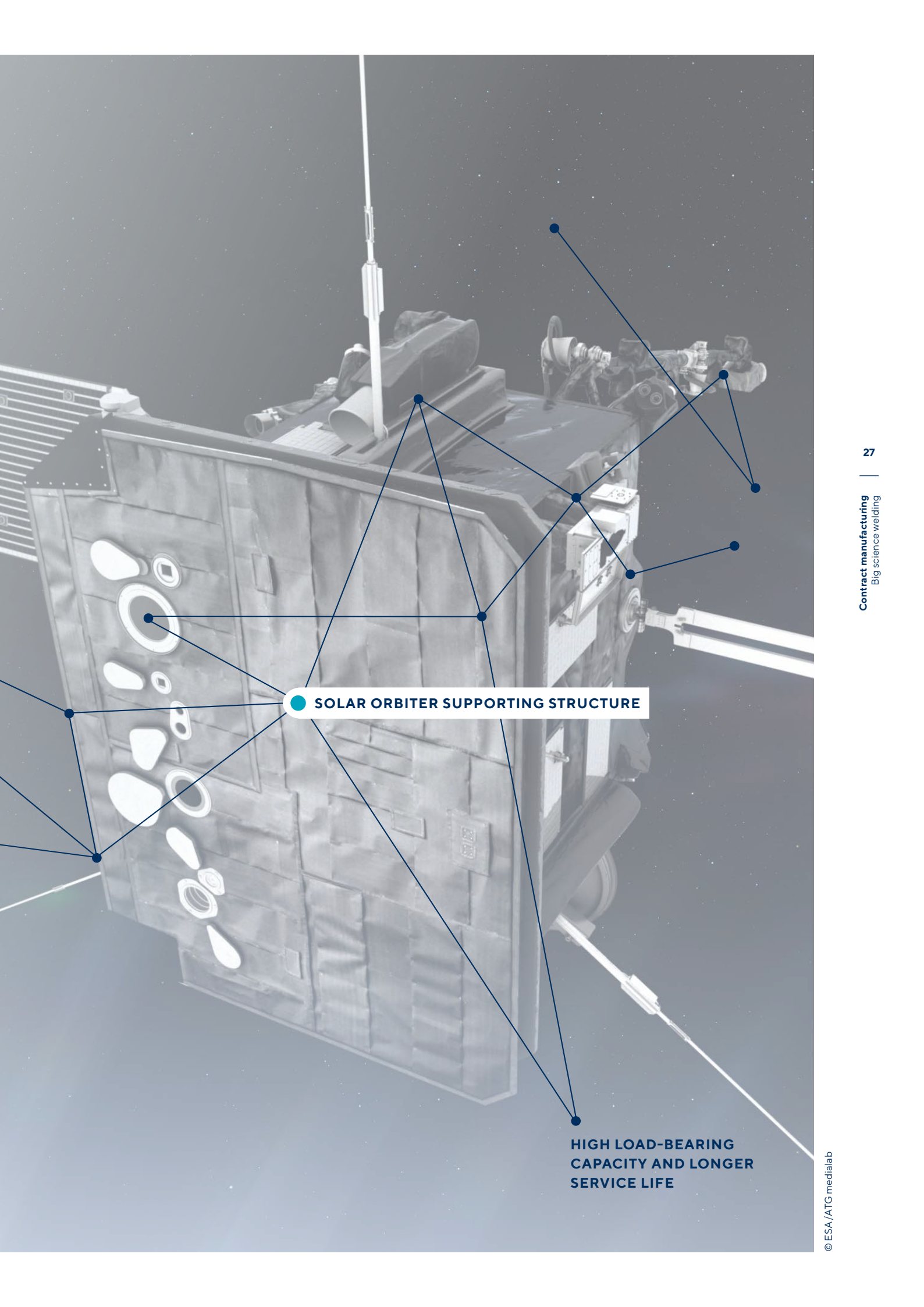

SOLAR ORBITER SUPPORTING STRUCTURE

**HIGH LOAD-BEARING
CAPACITY AND LONGER
SERVICE LIFE**

Decades of experience in large-scale research projects

Science and research place high demands on development partners with regards to their performance, precision and speed during large-scale projects. When it comes to joining, dimensional accuracy and long-term stability also play a decisive role.

With electron beam welding technology, pro-beam is perfectly positioned to meet these requirements. This technique welds seams in one pass and with the highest degree of precision and accuracy. The energy that is introduced into the component is comparatively low and enables nearly warp-free welding – narrow tolerances can thus be met and the manufactured components withstand the highest loads.

In addition, pro-beam also has modern, process-oriented and highly-available machinery at its disposal as well as an in-house development team that only focuses on large-scale research projects. Thanks to a comprehensive understanding of the inherent processes and environmental conditions for each project, our team is able to recognize unforeseen challenges early on and provide targeted solutions. Our robust organizational structures also enable us to meet schedules spread out over several months.

Our quality management process is subject to various standards – pro-beam works for the aerospace and energy industries, among others.

28

Big science welding
Contract manufacturing



FURTHER ADVANTAGES

- + High dimensional accuracy and long-term stability
- + Organizational structures for complex projects
- + Adherence to the highest quality standards
- + No component contamination due to atmospheric gases, such as oxygen



Component of the
ITER vacuum vessel

Applications



© ESA - D. Ducros

SOLAR ORBITER

The mission of the Solar Orbiter space probe is to investigate so-called space weather. The probe's main communications antenna, which will be used to send all the data collected back to Earth, was attached to a complex titanium carrier structure. This structure is therefore highly critical for the mission; it must be absolutely shock-resistant and be able to withstand temperatures of +500 °C to -270 °C.

The material to be welded as part of the carrier structure was a 2 mm thin sheet of titanium. After joining, there could be no residue gaps on it, as otherwise this could cause cracks. In addition, no seam correction could take place after the welding process due to the complexity of the structure and cleaning of the component was no longer possible.

That's why the carrier was welded using the electron beam technology from pro-beam. Using this process, seams that meet the demanded quality requirements could be welded exactly, precisely and carefully, while also meeting the delivery date.

VLT (VERY LARGE TELESCOPE)

The VLT for the European Southern Observatory (ESO) is one of the most advanced optical instruments in the world. It consists of several individual telescopes that can be interconnected to a gigantic interferometer – the VLT Interferometer.

One of the VLT's tasks is to investigate the content and processes of the very early universe. The MUSE (Multi Unit Spectroscopic Explorer), an integral field spectrograph, was developed for this, which operates in the visible wavelength range.

The frame for the MUSE optics was joined with the help of pro-beam's electron beam technology. A total of 24 individual tubes were to be welded to two plates, so that they would be joined together via the tubes. Finally after the detectors were mounted and connected in the frame, the instrument could then begin its task: locating objects that could not be found using regular imaging examinations.



© ESO/H.H.Heyer

ITER (INTERNATIONAL THERMONUCLEAR EXPERIMENTAL REACTOR)

Pro-beam is also involved in ITER, the world's largest research project. The fusion reactor of the same name has been designed to pave the way for a new, environmentally-friendly, efficient and safe energy source.

Using electron beam technology, pro-beam will be joining the heart of the fusion reactor, a massive, ring-shaped vacuum vessel. In future, this will be used to hold a gram of deuterium tritium gas on a narrow spiral track by a strong magnetic field. This will be heated to several million degrees and thus transferred into the plasma state. In this way, energy will hopefully be created based on the model of the sun.

Once the project has been completed, pro-beam will have welded approximately 470 components and thus generated more than 2400 seam meters, as well as over 1800 weld seams.



© ITER Organization

Hardening

Industries

- + Automotive industry
- + Mechanical and plant engineering

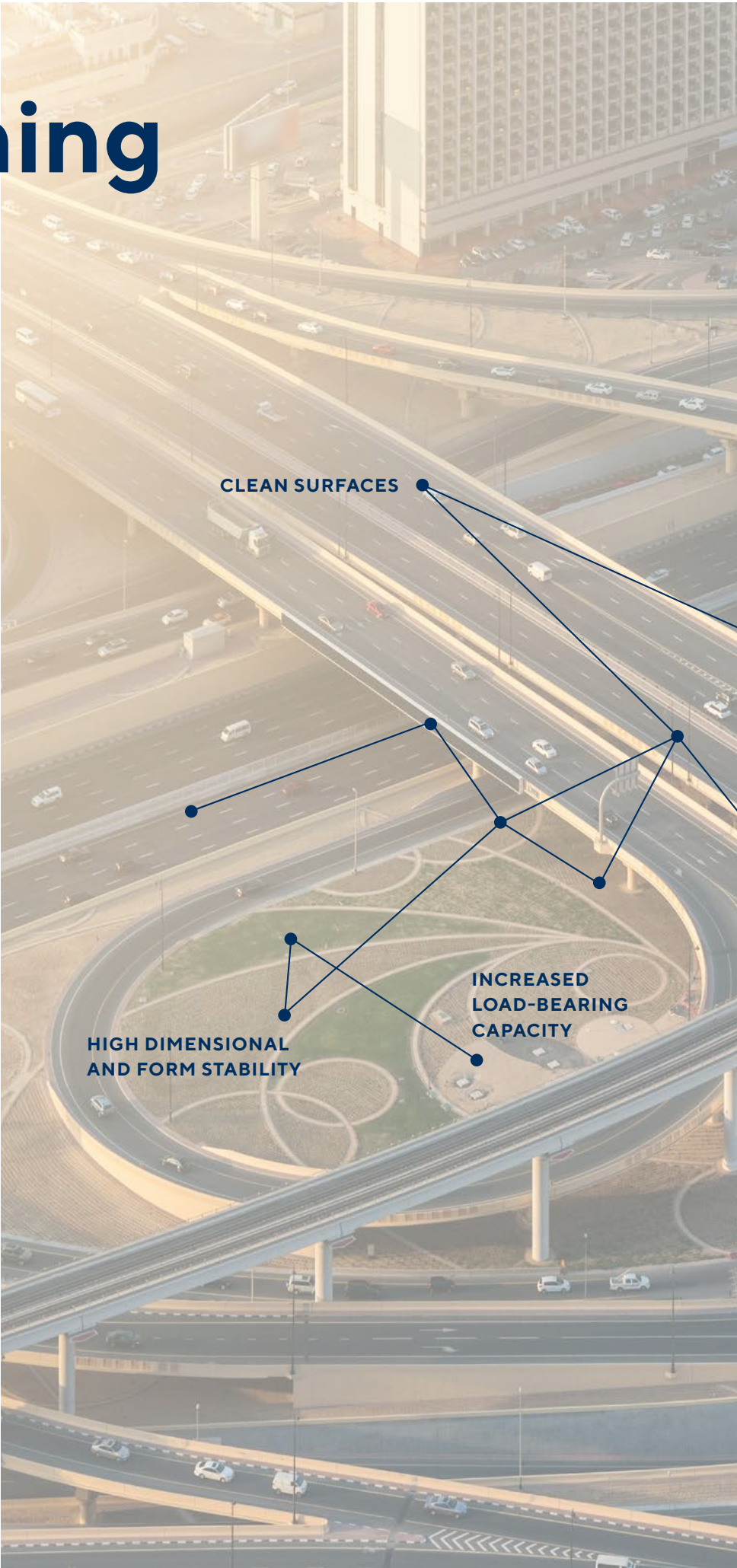

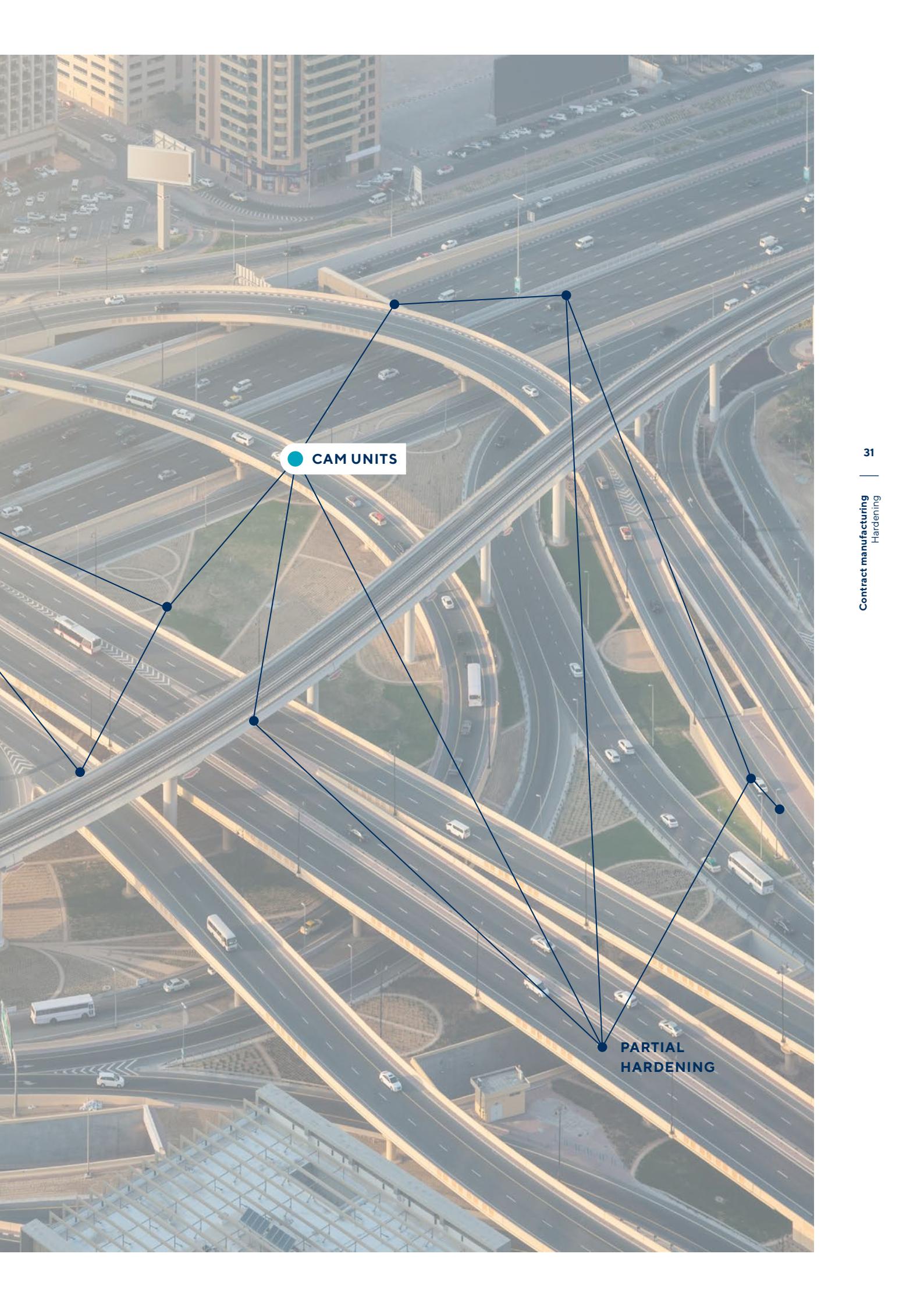

CAM UNITS

**PARTIAL
HARDENING**

Increasing the load-bearing capacity of workpieces using an electron beam

Electron beam hardening is ideally suited for the localized surface hardening of metallic components. Surfaces that are exposed to wear and tear as well as areas of components on which high levels of stress are exerted achieve a significantly longer service life after electron beam processing.

The unique feature of electron beam hardening: even complex contours can be partially hardened with minimal warping. This is achieved by briefly supplying energy, which is defined with geometric precision, to change the structure of the surface layer. The rest of the component remains ductile and soft.

At pro-beam, electron beam hardening is digitally controlled whereby all processes are easy to automate and can be perfectly reproduced. In addition, the hardening process has also been optimized to such an extent that there is often no need for costly post-processing, such as grinding or finishing processes. This process can be used on both carbon steels as well as many types of cast iron.

32



ADDITIONAL ADVANTAGES

- + Highest dimensional and form stability
- + Minimal thermal stress on the component
- + High productivity thanks to short treatment cycles
- + No post-processing required for hardened surfaces
- + No scaling
- + Hardening of nitrided surfaces possible

Applications



< **INDUSTRY:** Automotive
COMPONENT: Cam unit
PROCESSING: Partial hardening,
> 0,4 mm, > 650 HV

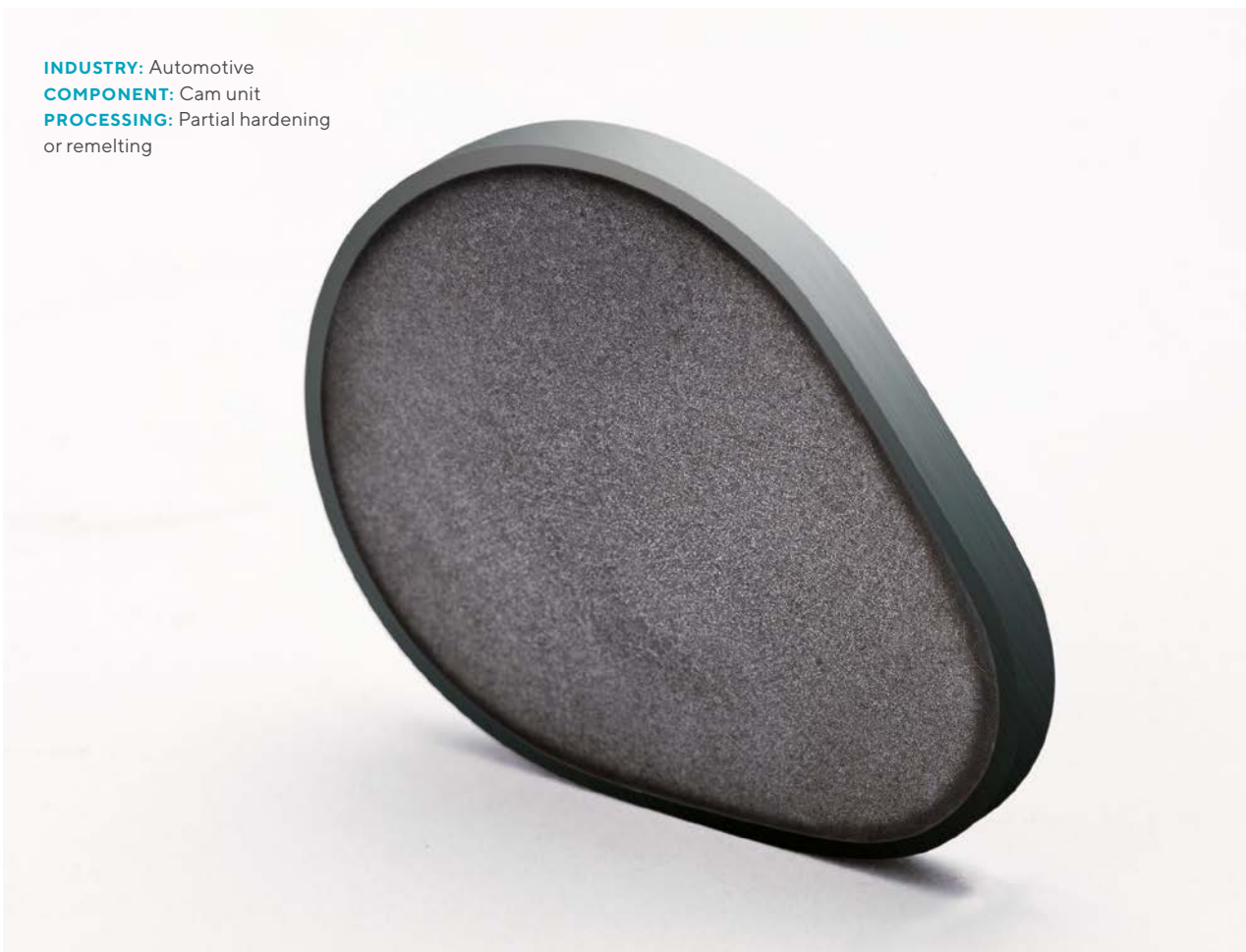

INDUSTRY: Automotive
COMPONENT: Cam unit
PROCESSING: Partial hardening
or remelting

Perforation

34

Perforation
Contract manufacturing

Industries

- + Food industry
- + Insulation industry
- + Paper industry
- + Plastics
- + Recycling
- + Mechanical engineering
- + Custom-made products
for different sectors



VARIOUS HOLE
COMBINATIONS

EFFICIENT AND
COST-EFFECTIVE



**LONG
SERVICE LIFE**

FRUIT JUICE FILTRATION

Drilling with the electron beam

Electron beam drilling is an efficient and cost-effective technology for the manufacture of industrial filters, screens and spinner discs. This is because the high energy density of the electrons melts sheets or cylindrical workpieces at a defined location without affecting the surrounding areas. The holes can also be applied at regular intervals on the surface – up to 25 percent open spaces are possible here. This results in holes with cylindrical through to conical shapes and a diameter of 0.06 to 1.1 mm. In addition, pro-beam perforation systems also operate with the highest precision when cre-

ating the hole diameter and can introduce up to 3,000 holes per second into the workpiece due to their speed. They are suitable for all metallic materials with a thickness up to 6 mm, including titanium, copper, aluminum and alloys with a high thermal stability, as well as other difficult-to-process metals.

The use of electron beam perforation ensures high component durability. This means that drilled filters are significantly more durable than wire mesh or woven fabric products.

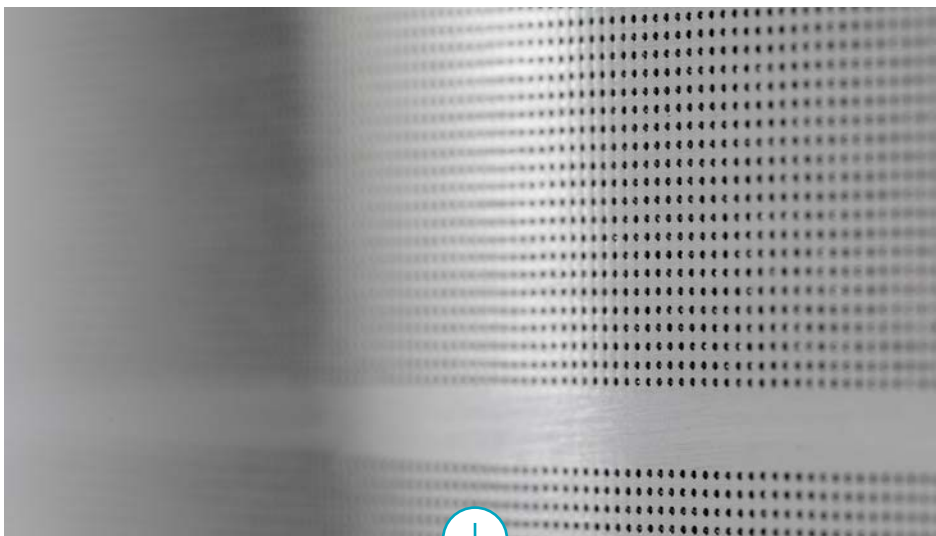

FURTHER ADVANTAGES

- + Efficient and cost-effective technology
- + Complete reproducibility thanks to digital process control
- + Maximum precision with low heat input and warping
- + Various hole combinations or slots are possible

Applications

PAPER INDUSTRY:
Waste water treatment
Ø 300 µm

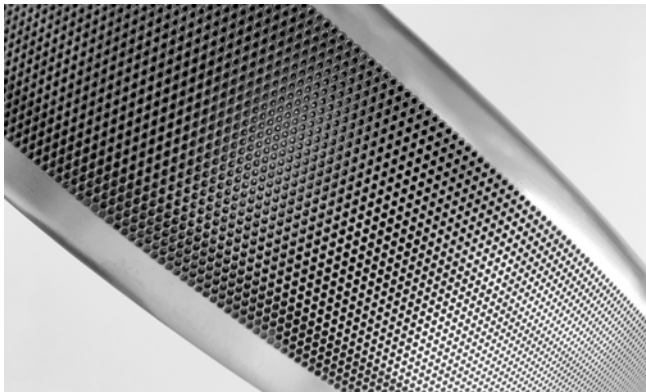

INSULATION INDUSTRY:
Centrifugal discs for glass wool production

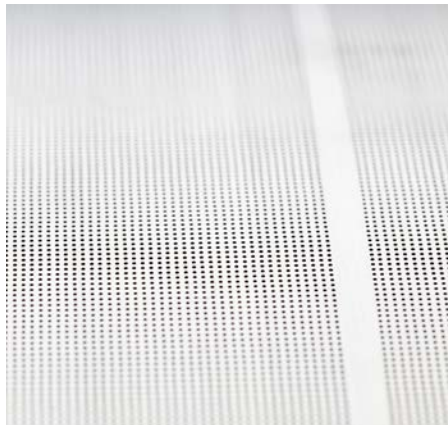
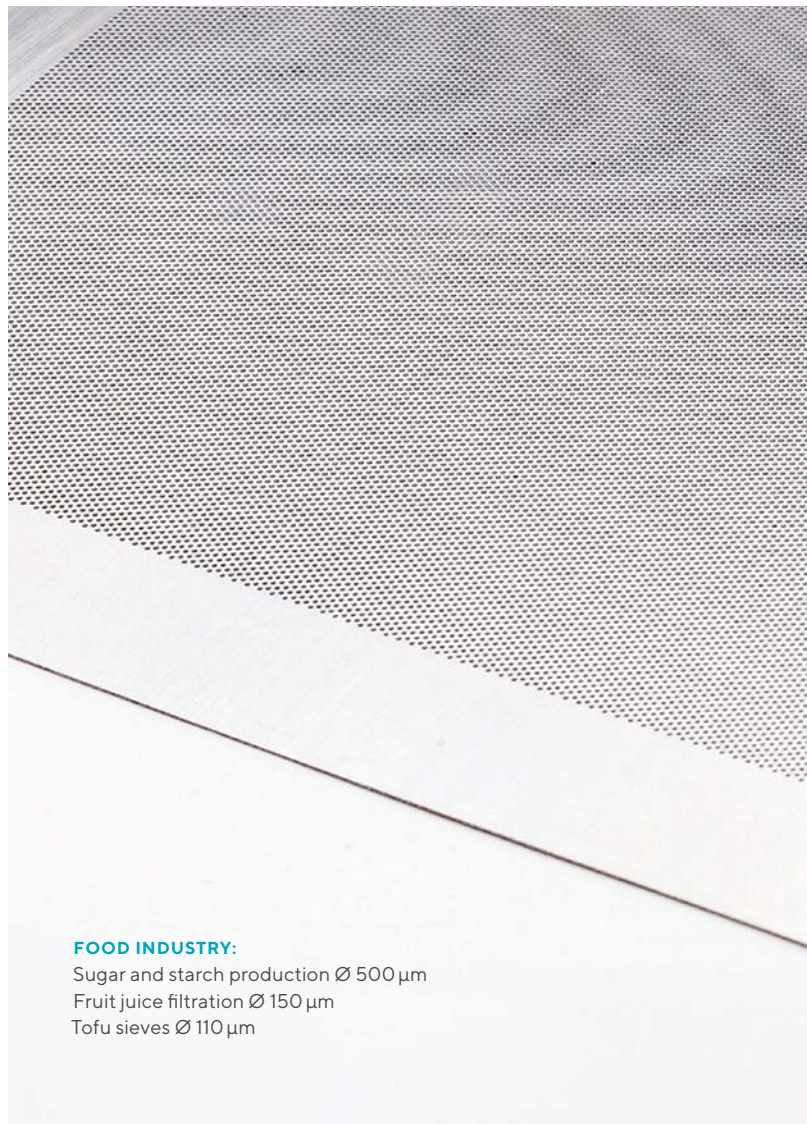

MECHANICAL ENGINEERING:
Filters for emulsion paint Ø 110 µm
Inserts for fluid bed dryers Ø 500 µm

FOOD INDUSTRY:
Sugar and starch production Ø 500 µm
Fruit juice filtration Ø 150 µm
Tofu sieves Ø 110 µm

Coating

38

Coating
Contract manufacturing

Industries

- + Semiconductor industry
- + Oil and gas
- + Medical technology
- + Food sector
- + Mechanical engineering

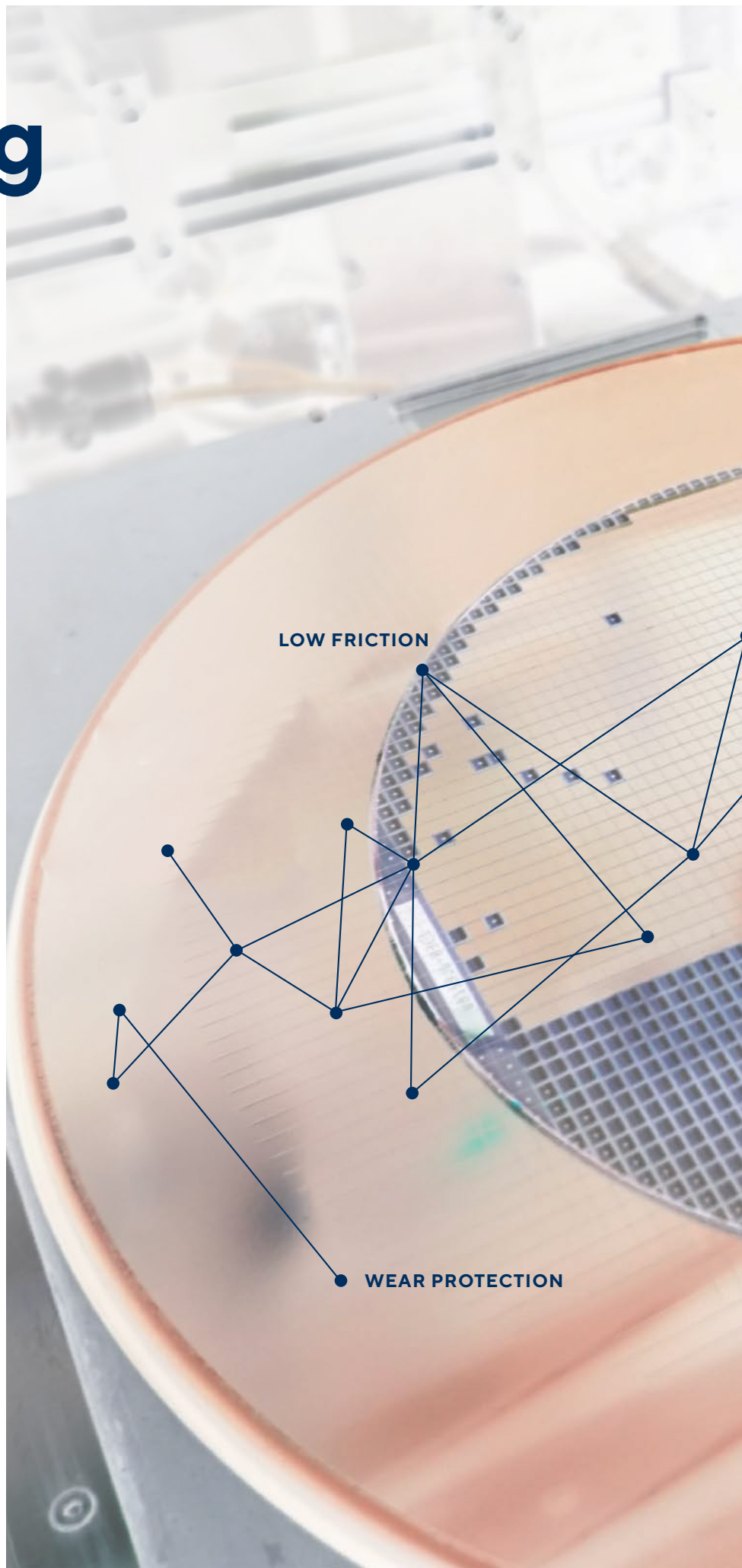

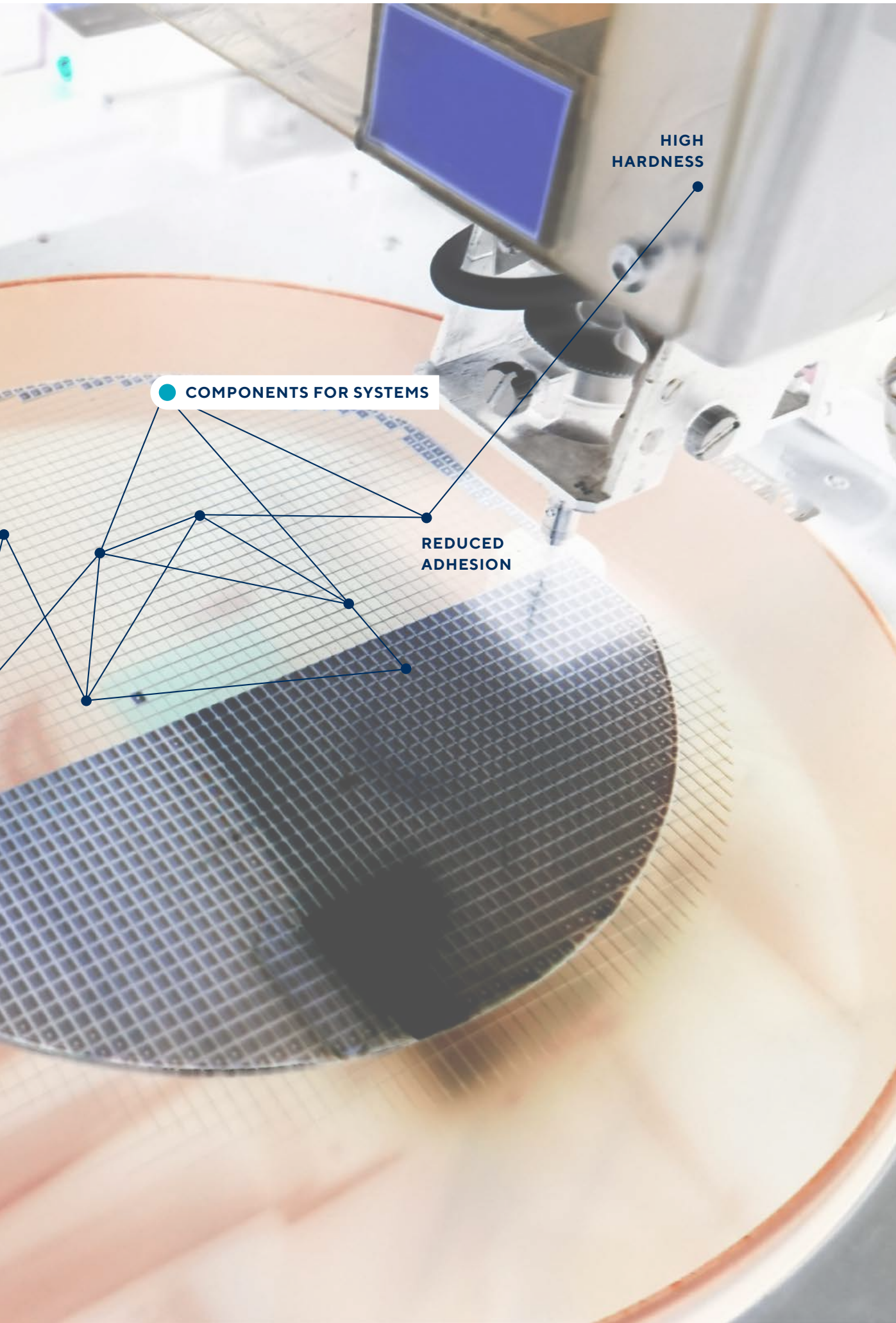

● **COMPONENTS FOR SYSTEMS**

**REDUCED
ADHESION**

**HIGH
HARDNESS**

Perfect surface protection with diadur®DLC

DLC coating (diamond-like carbon) protects components and tools against wear using a diamondlike carbon layer. Especially where surfaces move against each other and friction occurs, it ensures durability and increases performance. The diadur®DLC coating developed by pro-beam and field-proven for decades

is based on a state-of-the-art and environmentally friendly plasma process. The thermal stress is below 150 °C, which protects the components from loss of hardness and distortion. This special process makes it possible to coat metals and non-conductive materials, such as ceramics.

Hardness and anti-friction

MATERIAL HARDNESS IN COMPARISON:

Material	Hardness (HV)
Hardened steel	450
100Cr6	800-850
Diamond	10000
diadur®DLC	2500

COEFFICIENT OF FRICTION IN COMPARISON:

Material	Coefficient of friction
Steel	0.7
diadur®DLC	0.12

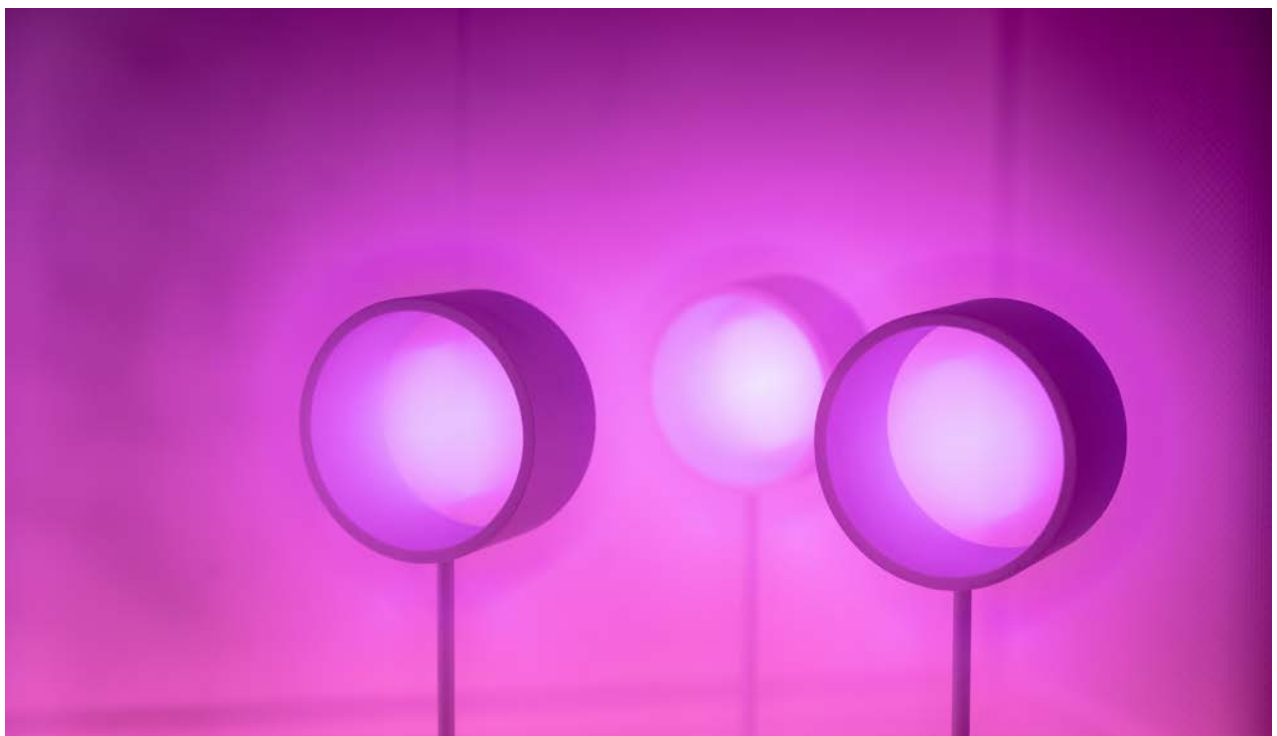



OUR SERVICES

- ✓ **Professional consulting**
From design and construction to production:
experienced since 1995
- ✓ **Sample and prototype coating**
- ✓ **Job coating**
Single parts up to high volume
- ✓ **Dimensions**
Coating of components with a length
up to 1300 mm
- ✓ **Coating of various materials**
Dielectric materials: SiC, Al₂O₃, etc.
Light metals, non-ferrous metals:
Aluminum, Titanium, etc.
All kinds of steel
- ✓ **Fully automated process control**
- ✓ **24 h coating service**
- ✓ **Measurement and testing
technology**
For thin films – also in service



BENEFITS OF DIADUR®DLC

- + **High level of hardness**
Excellent wear protection of
components and tools
- + **Low friction**
Reduces the use of lubricants and
increases performance
- + **Reduced adhesion**
No need for release agents
in forming processes
- + **Biocompatibility**
New applications in medical and
food technology
- + **Decorative applications**
Brilliant black appearance
- + **Wear protection**
Precise function under maximum load
- + **Increased service life**
Fewer service intervals for higher productivity
- + **Coating thickness 2 – 3 μm**

Applications

COATING OF DIVERSE MATERIALS:

Dielectric materials, light metals,
non-ferrous metals, all steels, ceramics

PRO-BEAM GROUP CERTIFICATES:

- EN ISO 9001
- IATF 16949:2016







Plant engineering

46 PRO-BEAM PLANT ENGINEERING

48 OUR SYSTEMS AT A GLANCE

50 SYSTEM MODULES

52 DIGITALIZATION AND AUTOMATION

Plant engineering

HIGH
PRODUCTIVITY

TURBINE HOUSING

FLEXIBILITY

Industries

- + Aerospace
- + Science and research
- + Automotive
- + E-mobility
- + Energy

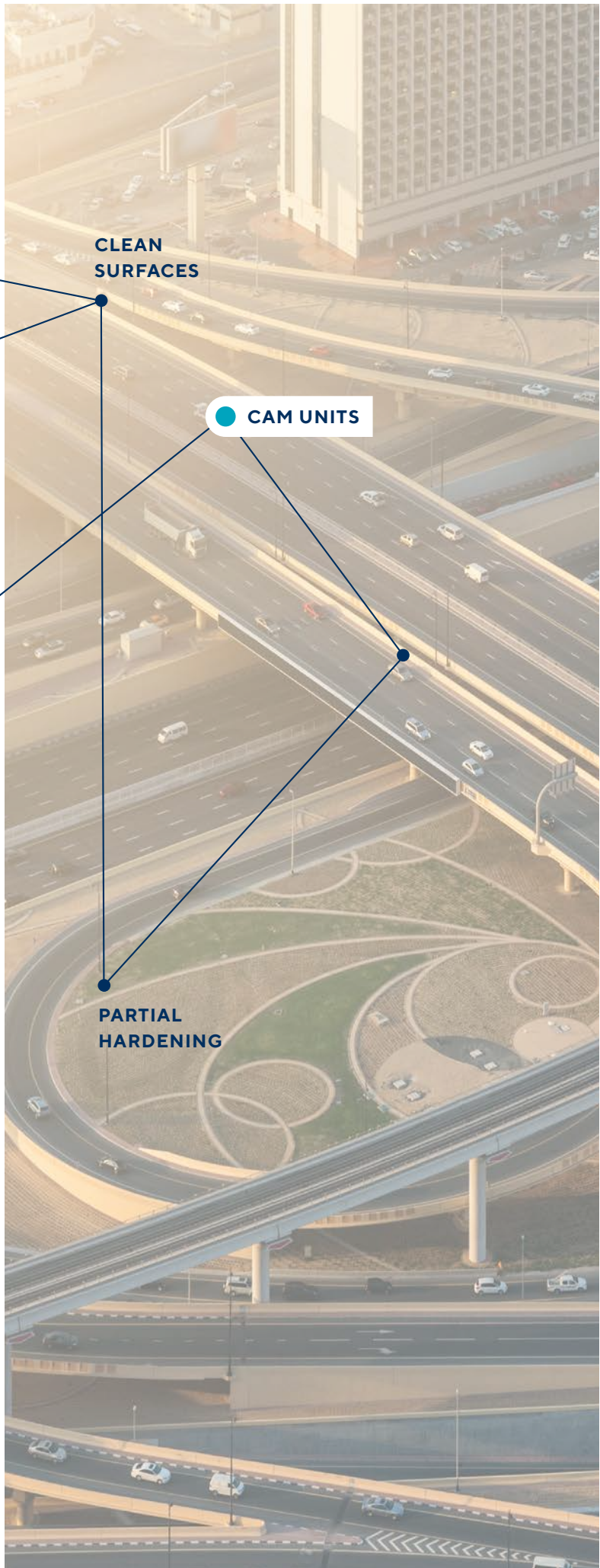
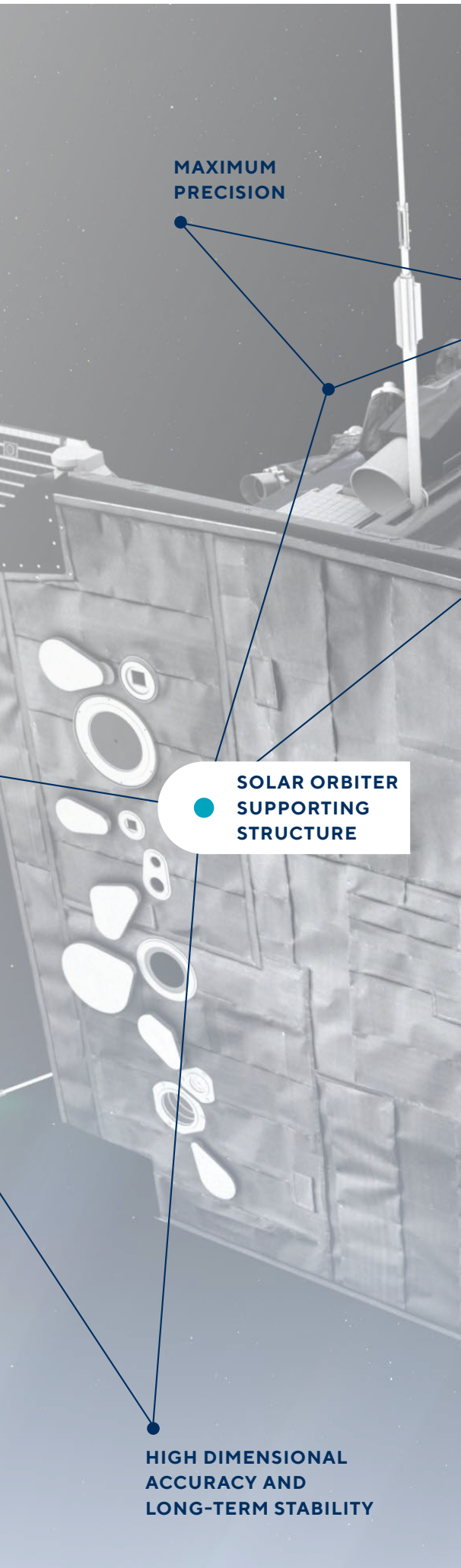

pro-beam plant engineering

A glimpse into a chamber system

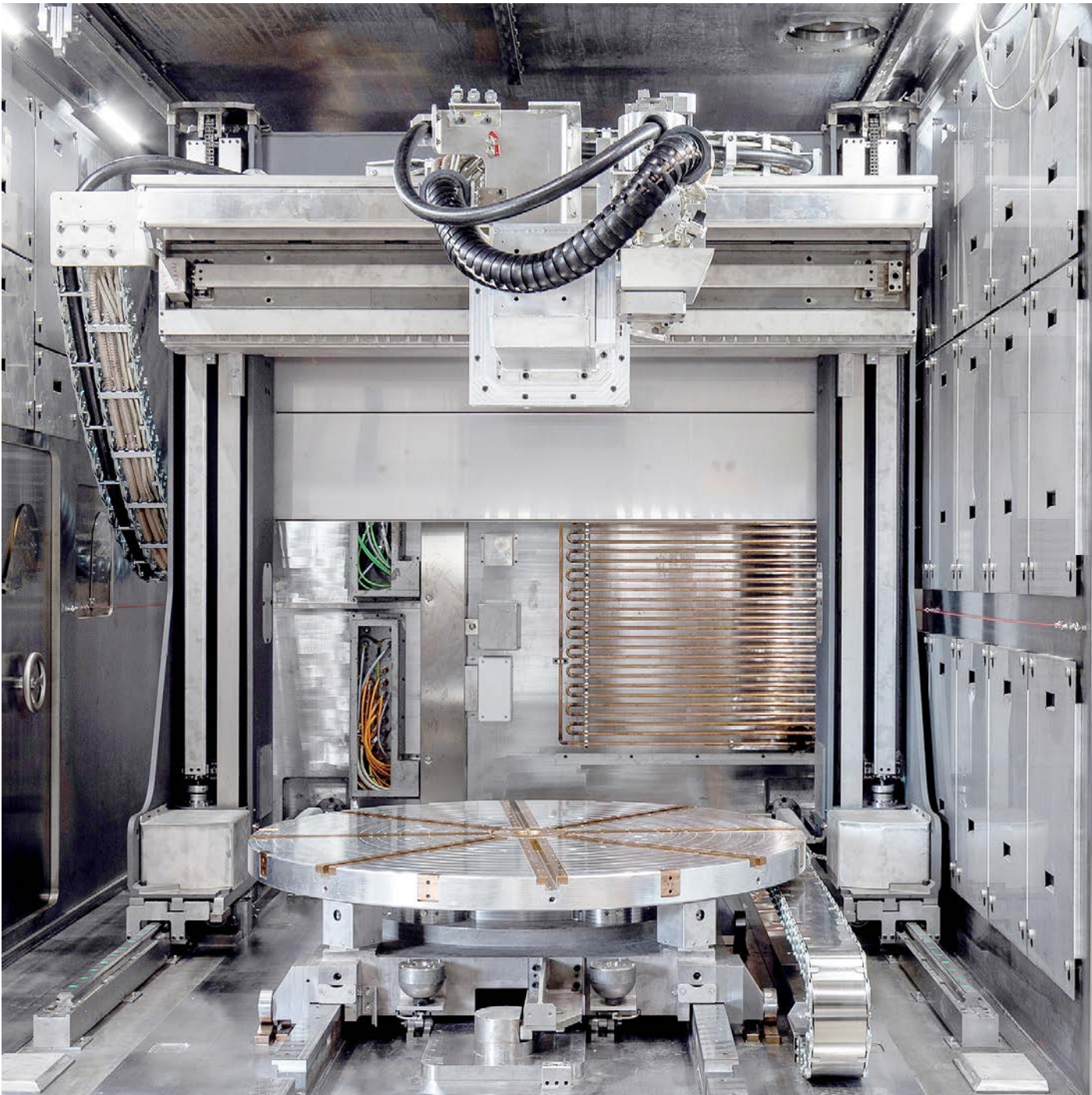

Powerful, automated and highly digitized systems are important prerequisites for high productivity and quality in modern manufacturing processes. We implement customer-specific systems and automation solutions - for one-piece batches to high-volume manufacturing for welding, perforating and hardening processes. Our system technology guarantees a high level of automation, high reproducibility and maximum productivity. Thanks to a modular design, each system can be individually adapted to meet your own requirements – even when it is already operational. We develop all our system components ourselves and perfectly synchronize them to the process engineering application.

Thanks to more than 45 years of experience in electron beam technology applications, we are the perfect partner for our customers from the very start of the development process.



ADDITIONAL ADVANTAGES OF PLANT ENGINEERING

- + From standalone systems to turnkey solutions
- + Systems to match your size of workpiece and scale of series production
- + Highly automated, digitally controllable and optimized for Industry 4.0 environments
- + Universal control unit for individual process control
- + EB vision image processing software for process visualization and automation



Our systems at a glance



CATEGORY

XS

S

M

INDUSTRY

Automotive

Mechanical and
plant engineering

Mechanical and
plant engineering,
research

DESCRIPTION

- + Highly productive single workpiece flow system with short cycle times due to automatic loading and unloading at the same time as processing
- + Small footprint

- + Load lock system
- + High productivity due to the parallelization of loading and the welding process
- + High flexibility for production changeover thanks to a modular pallet system

- + The chamber system is ideal for prototype and small-batch production
- + Compact version with a minimal footprint



L

XL

XXL

CATEGORY

Mechanical and plant engineering, aerospace

Aerospace

Power engineering, heavy machinery

INDUSTRY

- + Chamber system with external electron beam generator
- + For a wide range of different components
- + Available with flexible turning, swiveling and lifting equipment

- + Flexible system for the production of large components due to the use of an internal, mobile electron beam generator
- + Available with flexible turning, swiveling and lifting equipment or a pallet system

- + Large chamber system for large and heavy components
- + Internal, robot-controlled electron beam generator for welding complex workpieces

DESCRIPTION



OTHER SYSTEMS IN OUR PORTFOLIO

- + Perforation systems
- + UMH heating systems
- + Systems for laser welding in a vacuum
- + Turnkey solutions

System modules

Base modules of our E-beam systems

50

System modules
Plant engineering

1 VARIOUS BEAM GENERATORS

- + High-performance generator (up to 150 kV) for high-end applications
- + Compact generator for mobile use in the processing chamber
- + High energy efficiency



2 WORK CHAMBER

- + Work chamber available in various sizes, customized to your workpieces (from a few millimeters to several meters)
- + Splatter-free and clean components thanks to a vacuum in the chamber

PROCESS VISUALIZATION

3 EB-Vision

- + Smart software for process visualization and automation
- + Real-time recording of process-relevant data for quality assurance

UNIVERSAL CONTROL UNIT

4 MultiMod Controller

- + Intelligent beam control in real time
- + Freely programmable deflection figures
- + Flexible beam modulation for universal process design

5 Master CNC Controller Siemens 840 DSL

- + Synchronous table and beam movement
- + Multiple interpolation

3

EB-VISION

4

MULTIMOD

5

CNC

Individual customization options

- + **Various handling systems for workpiece processing**
Modular system with various configuration options depending on the processing task (e.g. pallet systems and turn-tilt lifting equipment) and expandable on demand
- + **Various solutions to increase productivity through parallelization of equipment, evacuation and processing**
For example, various load lock shuttle systems and revolving tables
- + **Efficient use of the processing space in the chamber**
thanks to generator displacement as an additional CNC axle
- + **Multi-beam technology**
The welding parameters and position of single beams can be individually customized, e.g. for warpage minimization and productivity increase
- + **Multi-process technology**
Simultaneous use of multiple processes (e.g. pre-heating, welding and seam smoothing) in one work step
- + **Welding with additional material for 3D contours**
For job and/or repair welding as well as build-up of structures on components

Digitalization and automation

Software and controller for intelligent visualization and control of the electron beam

The digitalization and automation of electron beam processes are at the very top of our agenda. We want to prepare our system customers optimally for the digital age and support them every step of the way. Therefore, we have further upgraded our EB Vision software as well as our MultiMod controller, the two most important tools for visualizing and controlling the electron beam. These tools are currently equipped with a number of functions that meet the new challenges of today's companies. Thus, processes carried out using the electron beam –

be it welding, hardening or perforation – operate 100% digitally, and can be automated and perfectly reproduced. Usability has also been improved dramatically. Thanks to the high level of automation, even untrained system operators are able to run the machine. In addition, several seams can be tracked simultaneously and then several points welded in parallel due to the multi-beam technology. This enables productive and cost-effective operation. Our digitized systems are also optimized for Industry 4.0 environments.

52

Data Analysis for quality control and traceability



Overview of the modules for the EB Vision software and MultiMod controller:

EB-Vision Software

BASE MODULES

ELO (Electron-Optical Monitoring):

- + Brilliant depiction of details, edges and seams
- + Visual evaluation of the welding upper bead possible

Scanning-Like Welding:

- + Image capturing along the entire processing contour
- + Recognition of positional deviations

Light Optics (depending on system equipment):

- + Display of HDR camera images
- + Manual brightness control

Crosshairs:

- + Visual orientation for precise positioning of the beam

OPTIONS

Data-Tracking: process data logging in real time

Customer-specific Seam Tracking: automatic seam tracking for complex and individual customer requirements

Automatic Seam Tracking: operator-independent and reproducible positioning of the electron beam for significantly higher cycle times

Automatic Beam Alignment: quick, operator-independent and reproducible set-up of the electron beam

Online ELO: observation of the welding process in real time

Data Analysis: analysis and visualization of the welding process for quality control and traceability

Free Contour Tracking: automatic correction of position deviations for longer or complex contours

MultiMod Controller

BASE MODULES

Master CNC Controller Siemens 840 DSL:

- + Standard CNC control and CNC syntax with MultiMod extension
- + Synchronous table and beam motion and multi-axis interpolation

MultiMod Controller:

- + Intelligent beam control in real time thanks to FPGA technology
- + Freely programmable, flexible beam modulation for universal process design
- + Basis for multi-beam technology

E-Beam Syntax:

- + CNC syntax for easy programming of the beam

OPTIONS

Advanced Multi-Beam Technology:

- + **Multi-beam Technology:** individual adjustment of single multi-beam processes
- + **Multi-Process Technology:** simultaneous implementation of multiple processes

Teach-in: manual generation of a processing contour

EB-Print: engraving/labeling of components, e.g. component number





Customer service



Customer service



**REMOTE SERVICE AND
ONLINE SUPPORT**

**FAST, RELIABLE,
SOLUTION-ORIENTED**

Industries

- + Mechanical and plant engineering
- + Aerospace
- + Automotive
- + E-mobility
- + Energy
- + Science and research



SERVICE HOTLINE

TRAINING

REPAIR

MAINTENANCE

Fast, reliable, solution-focused

Our goal is to ensure that our customers benefit unconditionally from the efficiency and precision of electron beam technology. We want to operate in a way that is fast, professional and completely satisfactory, and support our customers as a partner for the further development of their technology. In order to make this a reality in the future, we have decided to combine our customer service activities under the new pro-beam Service GmbH and expand our scope of services – from maintenance and repairs, the option for updates and upgrades to various retrofitting services.

Overview of our services

MAINTENANCE

- + Range of maintenance packages
- + Service contracts for regular maintenance intervals (ensures higher planning security and prioritization of customer orders)
- + Machine acceptance inspections in accordance with DIN 14744
- + Maintenance and repair of systems and components produced by other manufacturers (as per manufacturer specifications, e.g. vacuum pumps)
- + Latest vacuum technology and minimum evacuation time
- + Flexible and customized application

REPAIR

- + Very high availability of spare parts worldwide
- + Wide range of products (incl. special types), customization options
- + Fast global shipping
- + Customer-specific spare parts plan
- + Certified quality
- + Cathode servicing

TRAINING & CONSULTING

- + Customer-specific training for systems, CNC control, electron beam technology, maintenance and vacuum technology
- + Customized training for operators, planners, engineers as well as maintenance and service personnel
- + Tailored to specific requirements
- + On site at the customer's premises or at pro-beam

UPDATE

- + Component replacement to ensure spare part availability
- + Option to prepare for an upgrade to follow the update
- + Customized solution

UPGRADE

- + Expansion of technical functions (e.g. online ELO, teach function, measurement of the steel profile)
- + State-of-the-art technology from pro-beam

Retrofitting: needs-based replacement investments

In order to fully meet our customers' requirements, they can decide between a "core" and an "extended" package when choosing a retrofit from pro-beam. The difference is based on the design effort that goes into the system retrofit. After the first contact, a needs assessment takes place to find out the scope required for the system retrofit. After that, our service employees visit the site directly to inspect the system to find out which specific measures are required and feasible. Project and resource coordination takes place in close collaboration

with our customers to ensure short machine downtimes. With a retrofit from pro-beam, companies benefit from a number of advantages. Not only is the general operating life of the systems extended, but the customer also gets a future-proof machine for which individual spare parts supply is guaranteed. In addition, the retrofit also increases machine availability, simplifies system processes via modern technologies and the entire investment need is reduced when compared to a new investment.

RETROFITTING

- + Replacement investment
- + Increased availability and service life
- + Cost-optimizing integration of the latest technologies into existing systems
- + Modern, state-of-the-art beam, drive and control technology
- + Manufacturer's guarantee

RETROFIT CORE

Modernization measures focused on the core "electron beam" technology (in particular, the replacement of high-voltage supply and beam generator components)

RETROFIT EXTENDED

Modernization measures focused on the core "electron beam" technology (in particular, the replacement of high-voltage supply and beam generator components)



FURTHER ADVANTAGES OF THE CUSTOMER SERVICE

- + Fast, reliable, solution-focused
- + Service hotline from Monday to Friday 7:00 – 17:00 (GMT+1)
- + 24/7 hotline available on consultation
- + Remote service and online support
- + Service centers in Germany, England, China, USA and Mexico
- + Qualified service personnel and practical solutions
- + User-oriented TPM documentation and TPM support



Future projects

We are continually expanding our product portfolio in order to remain attractive to our customers and improve our ability to act as a partner. Therefore, in future we will be introducing a remote maintenance service that gives customers the opportunity to accelerate troubleshooting and fault resolution for their systems with the help of call channel access.

Our spare parts packages, which are designed to be modular and can be purchased addition-

ally when buying the system, are also being expanded significantly. After purchase, they can be stored on call at pro-beam.

In addition, plans are in the works to set up a pro-beam training center, which will be used to train system operators, designers and engineers in the use of pro-beam systems, as well as providing electron beam technology training.



Technology AMA Xpert Eye

In future, service will take place via data glasses. Alternatively, troubleshooting and resolution will also be possible via smartphone with call channel access.



pro-beam service employees support you in real time via a PC for resolution of the error.





New technology

E-Beam meets E-Mobility

Successfully advancing electromobility using electron beam technology

Short cycle times, a high level of automation and a low rejection rate are paramount in the automotive industry. That's why OEMs and suppliers have chosen to use electron beam technology in order to meet the challenges encountered when joining components for the chassis, drive train or engine for many years now.

This process is also predestined for the future area of electromobility. That's why we have further developed our technology in perennial research and development efforts, so that today we are positioned as the very first company to perform electron beam welding on components for electric vehicles. Electron beam joining is one of the most warp-free and highest quality welding processes. As such, it is the ideal process for achieving the high standards of long-term stability and leak tightness.



Applications

Copper hairpins

Hairpins made from copper are components of stators for electric drives. Even the welding of hairpins is an important consideration when it comes to the efficiency of the motor and thus the range of the vehicle. Using the electron beam, it is possible to join components reliably and with high-quality results. This process is especially well suited for the welding of copper components, because it does not produce any photo-optical effects, such as reflections. Using multibeam technology, several hairpin pairs can be joined simultaneously, ensuring efficient, economic operation.

Cooling systems

Even the weight of electric vehicles is a deciding factor that influences the range of the batteries. That's why manufacturers rely on light, cost-effective die-cast aluminum for the production of some vehicle components, e.g. for cooling systems. However, these systems must be handled precisely in order to not adversely affect the performance and service life of the battery. The electron beam tightly welds cooling systems with process reliability and ensures optimal stability and durability.

Battery housing

The batteries are given optimal protection by means of special aluminum housings. These help to ensure that the battery can power the vehicle drive without complications. When the housing is welded using an electron beam, this can generate stability, which supports the performance of the battery and contributes to its longevity.



SPECIAL ADVANTAGES OF THE E-BEAM FOR ELECTROMOBILITY

- + **Pore-free and splatter-free**
Electron beam welding in a vacuum is an uncomplicated process similar to vacuum drying in the automotive industry. Intelligent gate concepts also ensure that the generation of the vacuum does not adversely affect the production time. The results are clean, pore-free workpieces with almost no splatter.
- + **Seamless process data recording**
Electron beam welding is 100 % digital. Processes can be perfectly reproduced due to automatic beam adjustment, an automatic seam detection system, automatic welding and automatic quality control. The entire process can also be precisely monitored and integrated into a networked production environment.

**COMPANY HEADQUARTERS
CONTACT**

pro-beam GmbH & Co. KGaA
Zeppelinstraße 26
82205 Gilching
Germany
info@pro-beam.com