

Aluminium

Copper

Stainless steel

Nickel

Your key

to perfect welding.



Product range

Welding wires
Welding rods

mIGAL.CO

The Company

MIGAL.CO – your key to perfect welding!

MIGAL.CO (former MIGWELD) was founded in January 2000, is located in Landau/Isar, Bavaria and a manufacturer of high quality filler metals for MIG- and TIG-welding.

Wires from MIGAL.CO have excellent wire-feeding characteristics due to a certain surface treatment during manufacturing.



Aerial photo MIGAL.CO GmbH



Aluminium ore - Bauxit

Robot quality - constant products

The prerequisite for successful welding with industrial robots in the large scale production is a constant product, which ensures equal arc characteristics from batch to batch.

Our quality assurance already starts during the extraction of the aluminium ore Bauxit. Always the same supply chain from ore to the wire rod with a diameter of 9.5 mm provides alloys with the permanently identical fingerprint of the trace elements.

For the drawing of the wires, exclusively high-quality, non-slip drawing machines are used. This means that a separate speed-controlled drive is available for each die. This thus reliably avoided slip ensures optimum surface quality.



Office building



Aluminium oxide



Non-slip drawing machine



Strip from the casting wheel

MIGAL.CO Quality

Tolerance of diameter and surface purity

According to the standard DIN EN ISO 544 the maximum tolerance of a 1.2 mm wire electrode of GMAW welding must not exceed +0.01/-0.04 mm from its nominal value.

Diameter [mm]	Deviation	Area of cross section [mm ²]	Deviation
1,21	0,83%	1,15	1,65%
1,20	0,00%	1,13	0,00%
1,18	-1,67%	1,09	-3,31%
1,16	-3,33%	1,06	-6,48%

MIGAL.CO only uses drawing dies made from diamonds and this puts us in a position to keep the diameter tolerance constant within +0.0/-0.02 mm. Hence, the maximum deviation of the wire feed speed is limited to 3.31%.

Under practical conditions this means that the arc length correction doesn't require adjustment after changing to a new batch of wire. This is of utmost importance with all mechanized and robotic welding.

The surface cleaning at MIGAL.CO is done by a multiple, mechanical and cutting process, which is known by experts under the term "shaving". In opposite to chemical cleaning processes this guarantees cleanest surfaces, nothing but pure metal!



The wire diameter and the ovality of the wire are permanently laser-controlled during the production process and deviations lead to warnings or to a stop of the production line.



Respoiler for twist-free drums

Twist-free wires

For optimum processing of wire electrodes for MSG welding, these must be free of twist. This ensures a precise positioning of the wire electrode end in the TCP (tool-center-point), especially in robot welding, and avoids the formation of knots when barrels are unwound. The wire drawing machines used at MIGAL.CO have special devices to adjust the freedom from twist.

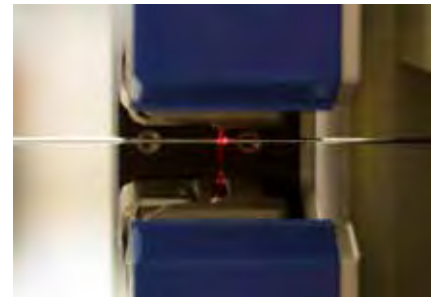

Diameter control by laser



Twist-free drawing machine

Quality Control

Residual analysis - precision in surface coating

Pure Aluminium does not glide through wire feeding systems and obtaining a simultaneous compromise between superior gliding characteristics and utmost surface purity is certainly the secret of each manufacturer. This is also true for MIGAL.CO, even though we believe to have an extraordinary useful solution to this challenge.

Naturally, mistakes that lead to surface impurities can happen in every production plant, but nonetheless poor storage or dirty wire feed systems may lead to unclean wires as well. With Aluminium this is particularly sensitive due to the problems with Hydrogen (see page 37) in opposite to most other metals and often very critical during practical applications of welding. Therefore, we have wondered a lot how we could be able to judge about the surface cleanliness of wires quickly and at user's sites. This has led us to the development of our residual analyser.



Residual analyzer

Using a fast and stepless adjustable inverter power source we heat the wire until shortly below the melting point. The surface impurities evaporate and are collected by a special extraction device. The quantity of fume is measured with an optical sensor.

The measuring results are displayed graphically and numerically on a PC user interface and may be documented as required.

The analyser is portable and can be used right at the user. If difficulties i. e. porosity occur, we are quickly able to assess the surface impurities of wire electrodes.

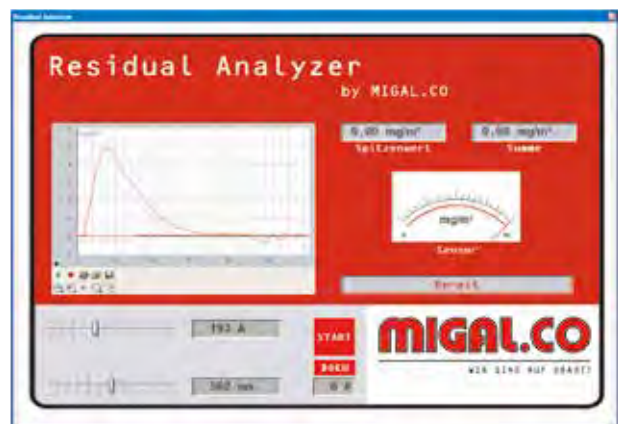

Residual analyzer panel

Quality Control

Welding robot and digital image radiography

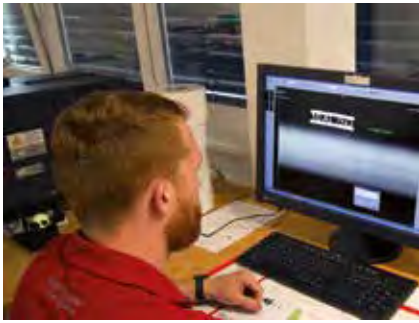

Digital image radiography

The only decisive criterion in the assessment of the product quality of filler metals is provided by the welding test with subsequent radiography.

A specially designed industrial robot with statistical process analysis combined with a digital X-ray system enables us to demonstrate the quality of processing and the freedom of porosity of our products before delivery.

Spectral analysis, tensile test and coefficient of friction

In our laboratory, we can also control the chemical composition of our products at any time, determine the tensile strength, yield strength and elongation of the wires, and measure the friction coefficient of the wire electrodes.



X-ray cabinet

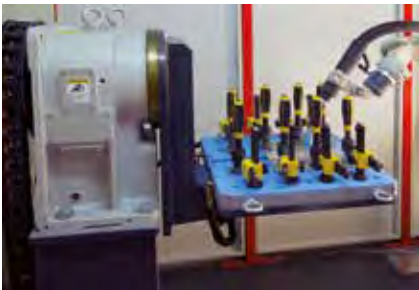

Welding robot



Tensile test



Spark emission spectrography



Measurement of the coefficient of friction

Quality Control

Standard vacuum packaging of MIGAL.CO welding wire

At the ISF - Welding and Joining Institute at the RWTH Aachen University, „Investigations of the influence of the material-dependent properties of aluminum wire electrodes on the stability and the welding results of GMAW-processes“ were conducted from 2013 to 2016.

These came to the clear conclusion that only such wires lead to pore formation in the weld metal, on which condensation has taken place. Condensation due to rapid changes in ambient temperatures and atmospheric humidity occurs additionally to the storage, especially during transport, without influence of the manufacturer or receiver.

The plastic packings of wire electrodes used to date for MSG welding wires are by no means dense and this leads to condensation conditions, hydrogen absorption and subsequent pore formation during welding.

MIGAL.CO, as first manufacturer in the world, has consistently decided to pack all wire electrodes on coils of 0.5 - 40 kg in aluminum composite foil and vacuum. This ensures the control of the unsealed packaging by the user and a safe protection of the wire electrode against hydrogen absorption, even during storage or transport during condensation conditions.



B300 vacuum packaging

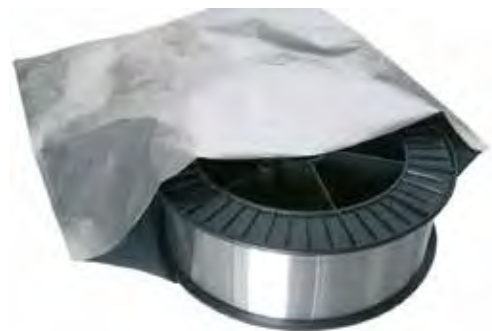

S300 before welding

The Centre of Technology

Know how: We deliver not only the product, but also the solution!

Arc welding technology



Progress of microelectronics has enabled further development of the technological „welding arc“ tool considerably during the last years. New process variants like high-deposition GMAW, MIG-brazing, welding with flattened wires or GMAW-AC processes have been developed.

At the same time already known processes i. e. Plasma-MIG-welding are being reminded of and new hybrid-processes like Laser-MIG-welding are invented.

These advances in arc welding technologies can be used to improve quality and productivity of welded structures, which get more important due to global competition. Also thermal cutting has new developments i. e. high focus plasma cutting which provides cuts that don't require any further refinish.

The general conditions and parameters of these new processes can not be found in literature and there is a lack of practical experience. There are just too many combinations of materials, welding positions, joint designs, tolerances and requirements to the joint. To find the right answer for each specific application there is only one way: Try!

In order to “try” professionally and to be able to offer new and profitable solutions to our costumers we have established our centre of technology. Here we are able to use and compare different arc processes under practical conditions and we can evaluate the joints by destructive and non-destructive testing. Even more important, these solutions are found within short notice and on the basis of industrial available products which makes them immediately applicable in industrial environments.

In order to provide the entire range of destructive and non-destructive testing to our costumers we establish partnerships with various universities and institutes related to welding and thermal cutting.

The facilities in our centre of technology include among others a CNC-cutting machine, a six-axis industrial robot with external axis, longitudinal and circumferential welding machines, power sources for various welding processes, equipment for joint preparation and destructive testing.



The Internet

E-Commerce

We have been using the world wide web right from the beginning and have it woven deeply into our business processes. Our costumers are able to download information directly from our databases and get their requested data precisely, quickly and of course round the clock.

Certificates

We supply all our consumables with a certificate according to EN 10204-3.1. These certificates may be downloaded, even after years, by www at any time in superior quality.



Just by surfing to www.migal.co, entering the batch number of the consumable and then selecting the diameter and spool type the certificate appears as a pdf-File and may be locally stored or printed as necessary

By these means an optically perfect and properly designated document is provided.

Shoplist

Our webpages are linked to the PPS computer systems directly. This makes it possible to show the quantities of each product in our warehouse in kilograms.



The Internet

Metal supplements

The metals, of which our filler metals are made from, are traded on the international stock markets, and this causes daily fluctuations of its prices. This is the reason why our sales prices are always divided in a base price and a variable supplement. The supplement is calculated from the changes of the relevant metal prices in the past month. We will inform you about the basics of these calculations on request.

CAUTION: The application of the metal supplements is always based on the month of delivery, and not on the date of order.

Our homepage offers much more information like a material calculator to find the best filler metal for given base metals, a dew point calculator, as well as additional product and application information.

Just surf to www.migal.co and have a look!

The screenshot displays the MIGAL.CO website interface. At the top, there is a navigation menu with links for Home, About us, Contact, News, and Services. Below the header, a red banner features the MIGAL.CO logo and a decorative graphic. The main content area is titled "Metal supplements - always up-to-date" and includes a brief explanation of how the supplement is calculated based on metal price changes over the last month. Below this, there are two tables: "Active" and "Inactive".

Designation	Base material	Valid for	Price/kg
Aluminum Supplement + casting (ADT)	ALU	Aluminum	0.13
Aluminum LAM	ALU	Aluminum	0.13

Designation	Base material	Valid for	Price/kg
Carbon Supplement (CS)	CS	AL, Cu, Ni, Ag, Au, Co, Cr, Fe, In, K, Mg, Mn, Mo, Ni, Nb, Pd, Pt, Si, Sn, Ti, Ta, V, W, Zr, Zn	0.07
Carbon Supplement (CS) - 100, 1000	CS	AL, Cu, Ni, Ag, Au, Co, Cr, Fe, In, K, Mg, Mn, Mo, Ni, Nb, Pd, Pt, Si, Sn, Ti, Ta, V, W, Zr, Zn	0.07
Carbon Supplement (CS) - 100, 1000	CS	AL, Cu, Ni, Ag, Au, Co, Cr, Fe, In, K, Mg, Mn, Mo, Ni, Nb, Pd, Pt, Si, Sn, Ti, Ta, V, W, Zr, Zn	0.07
Carbon Supplement (CS) - 100, 1000	CS	AL, Cu, Ni, Ag, Au, Co, Cr, Fe, In, K, Mg, Mn, Mo, Ni, Nb, Pd, Pt, Si, Sn, Ti, Ta, V, W, Zr, Zn	0.07
Carbon Supplement (CS) - 100, 1000	CS	AL, Cu, Ni, Ag, Au, Co, Cr, Fe, In, K, Mg, Mn, Mo, Ni, Nb, Pd, Pt, Si, Sn, Ti, Ta, V, W, Zr, Zn	0.07
Carbon Supplement (CS) - 100, 1000	CS	AL, Cu, Ni, Ag, Au, Co, Cr, Fe, In, K, Mg, Mn, Mo, Ni, Nb, Pd, Pt, Si, Sn, Ti, Ta, V, W, Zr, Zn	0.07
Carbon Supplement (CS) - 100, 1000	CS	AL, Cu, Ni, Ag, Au, Co, Cr, Fe, In, K, Mg, Mn, Mo, Ni, Nb, Pd, Pt, Si, Sn, Ti, Ta, V, W, Zr, Zn	0.07
Carbon Supplement (CS) - 100, 1000	CS	AL, Cu, Ni, Ag, Au, Co, Cr, Fe, In, K, Mg, Mn, Mo, Ni, Nb, Pd, Pt, Si, Sn, Ti, Ta, V, W, Zr, Zn	0.07
Carbon Supplement (CS) - 100, 1000	CS	AL, Cu, Ni, Ag, Au, Co, Cr, Fe, In, K, Mg, Mn, Mo, Ni, Nb, Pd, Pt, Si, Sn, Ti, Ta, V, W, Zr, Zn	0.07
Carbon Supplement (CS) - 100, 1000	CS	AL, Cu, Ni, Ag, Au, Co, Cr, Fe, In, K, Mg, Mn, Mo, Ni, Nb, Pd, Pt, Si, Sn, Ti, Ta, V, W, Zr, Zn	0.07

Designation	Base material	Valid for	Price/kg
Carbon Supplement + casting	CS	AL, Cu, Ni, Ag, Au, Co, Cr, Fe, In, K, Mg, Mn, Mo, Ni, Nb, Pd, Pt, Si, Sn, Ti, Ta, V, W, Zr, Zn	0.07
Carbon Supplement + casting	CS	AL, Cu, Ni, Ag, Au, Co, Cr, Fe, In, K, Mg, Mn, Mo, Ni, Nb, Pd, Pt, Si, Sn, Ti, Ta, V, W, Zr, Zn	0.07
Carbon Supplement + casting	CS	AL, Cu, Ni, Ag, Au, Co, Cr, Fe, In, K, Mg, Mn, Mo, Ni, Nb, Pd, Pt, Si, Sn, Ti, Ta, V, W, Zr, Zn	0.07
Carbon Supplement + casting	CS	AL, Cu, Ni, Ag, Au, Co, Cr, Fe, In, K, Mg, Mn, Mo, Ni, Nb, Pd, Pt, Si, Sn, Ti, Ta, V, W, Zr, Zn	0.07
Carbon Supplement + casting	CS	AL, Cu, Ni, Ag, Au, Co, Cr, Fe, In, K, Mg, Mn, Mo, Ni, Nb, Pd, Pt, Si, Sn, Ti, Ta, V, W, Zr, Zn	0.07
Carbon Supplement + casting	CS	AL, Cu, Ni, Ag, Au, Co, Cr, Fe, In, K, Mg, Mn, Mo, Ni, Nb, Pd, Pt, Si, Sn, Ti, Ta, V, W, Zr, Zn	0.07
Carbon Supplement + casting	CS	AL, Cu, Ni, Ag, Au, Co, Cr, Fe, In, K, Mg, Mn, Mo, Ni, Nb, Pd, Pt, Si, Sn, Ti, Ta, V, W, Zr, Zn	0.07
Carbon Supplement + casting	CS	AL, Cu, Ni, Ag, Au, Co, Cr, Fe, In, K, Mg, Mn, Mo, Ni, Nb, Pd, Pt, Si, Sn, Ti, Ta, V, W, Zr, Zn	0.07
Carbon Supplement + casting	CS	AL, Cu, Ni, Ag, Au, Co, Cr, Fe, In, K, Mg, Mn, Mo, Ni, Nb, Pd, Pt, Si, Sn, Ti, Ta, V, W, Zr, Zn	0.07
Carbon Supplement + casting	CS	AL, Cu, Ni, Ag, Au, Co, Cr, Fe, In, K, Mg, Mn, Mo, Ni, Nb, Pd, Pt, Si, Sn, Ti, Ta, V, W, Zr, Zn	0.07

Metal supplements subscription

Subscribe to the monthly metal supplements.

Your name: _____

Email: _____

Are you subscribed already and wish to unsubscribe to our mailings? [Click here](#).

Spools and Packaging

<p>S 100</p>  <p>Spool S 100 with dimensions: 100 mm, 100 mm, 100 mm.</p>	<p>S 200</p>  <p>Spool S 200 with dimensions: 200 mm, 45 mm.</p>	<p>S 300</p>  <p>Spool S 300 with dimensions: 300 mm, 100 mm.</p>
<p>B 300</p>  <p>Spool B 300 with dimensions: 300 mm, 100 mm, 100 mm.</p>	 <p>MIGAL.CO WELDING WIRE box.</p>	<p>BS 300</p>  <p>Spool BS 300 with dimensions: 300 mm, 100 mm.</p>
<p>B 400 18 kg</p>  <p>Spool B 400 with dimensions: 400 mm, 180 mm.</p>	 <p>MIGAL.CO WELDING WIRE box.</p>	<p>B 400 40 kg</p>  <p>Spool B 400 with dimensions: 400 mm, 180 mm, 210 mm.</p>
<p>TIG welding rods</p>  <p>MIGAL.CO WELDING WIRE box.</p>	 <p>Spool B 400.</p>	<p>TIG welding rods</p>  <p>TIG welding rods.</p>

For further information regarding the content of this page see www.migal.co

Spools and Packaging

Eco-Drum - your key to an ecological package



*Eco-Drum
on Multi-Purpose-Carriage UFTW1*

Our Eco-Drum is designed for all users of mechanized and robotic welding applications. It is mainly used for alloys of the 1000 and 4000 material group.

The Eco-Drum contains 80 kg of Aluminium wire or 200 kg of Copper wire. Of particular interest to bulk users is certainly CuSi3 1.0 mm which is used in a great scale for MIG-brazing. The Eco-Drum makes it possible to use a bulk supply without the otherwise necessary expensive and maintenance prone unwinding equipment. An integrated window provides visual wire end control.

The drum is just paper and can be burned or disposed of as waste paper.

Dimensions: Diameter 500 mm
Height without decoiling hood 820 mm
Height with decoiling hood 1.080 mm

Jumbo - for real bulk users

The Jumbo drum is the bulk pack for all large consumers of aluminium welding wire. All alloys from our Aluminium and Copper consumables can be reeled off out of our Jumbo-Drum.

Even wire diameters of 1.0 mm and alloys of the 5000 series can be decoiled without any problem. Due to the bigger diameter the wire comes nearly straight of the pack and is especially suitable for laser welding.

Jumbo is ecological as well and may be disposed of easily. An integrated control window enables a visual wire end control.

Dimensions (L x W x H): 600 x 600 x 900 mm (without decoiling hood), height with decoiling hood 1.250 mm.



*Jumbo-Drum with Decoiling Hood
on Multi-Purpose-Carriage UFTW1*

Spools and Packaging

Physical design of the welding system when using drums

A trouble free use of drums needs much know-how and experience. Already the physical design of the welding system must be adapted to drums. An example of a robotic cell is shown here.

We like to support you already during the planning stage of your robotic system - just ask us.

The basic criteria for successful wire-feeding is shown in the image.

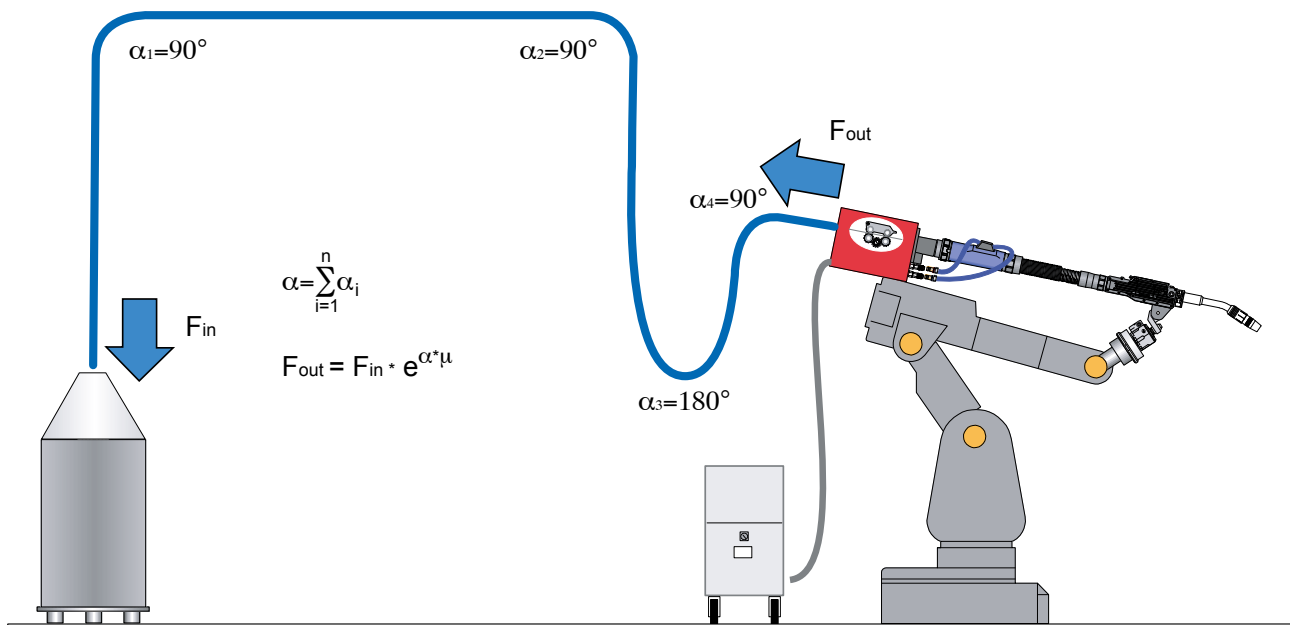

Schematic layout of a robotic welding cell with bulk-wire supply and the related forces due to friction

For greater distances from the drum to the wire feeder we recommend our Rolliner. For further information about the Rolliner and suitable accessories for wire drums e. g. decoiling cones, wire end sensors, wire feed conduits and transport aids ask for our catalogue „Your Key To Perfect Wire Transport“.



Indicative tables

Chemical compositions

Aluminium alloys

	Single values are maximum values (%)										Unspecified elements		Al
	Si	Fe	Cu	Mn	Mg	Cr	Zn	Be	Ti	Zr	Single	Total	
MA-1070	0,20	0,25	0,04	0,03	0,03		0,04	0,0003	0,03		0,03		≥ 99,70
MA-1450	0,25	0,40	0,05	0,05	0,05		0,07	0,0003	0,10 - 0,20		0,03		≥ 99,50
MA-2319	0,20	0,30	5,80 - 6,80	0,20 - 0,40	0,02		0,10	0,0003	0,10 - 0,20	0,10 - 0,25	0,05	0,15	Rest
MA-4043	4,50 - 6,00	0,60	0,30	0,15	0,20		0,10	0,0003	0,15		0,05	0,15	Rest
MA-4047	11,00 - 13,00	0,60	0,30	0,15	0,10		0,20	0,0003	0,15		0,05	0,15	Rest
MA-5087	0,25	0,40	0,05	0,70 - 1,10	4,50 - 5,20	0,05 - 0,25	0,25	0,0003	0,15	0,10 - 0,20	0,05	0,15	Rest
MA-5183	0,40	0,40	0,10	0,50 - 1,00	4,30 - 5,20	0,05 - 0,25	0,25	0,0003	0,15		0,05	0,15	Rest
MA-5356	0,25	0,40	0,10	0,05 - 0,20	4,50 - 5,50	0,05 - 0,20	0,10	0,0003	0,06 - 0,20		0,05	0,15	Rest
MA-5554	0,25	0,40	0,10	0,50 - 1,00	2,40 - 3,00	0,05 - 0,20	0,25	0,0003	0,05 - 0,20		0,05	0,15	Rest
MA-5556	0,25	0,40	0,10	0,60 - 1,00	5,00 - 5,50	0,05 - 0,20	0,20	0,0003	0,05 - 0,20		0,05	0,15	Rest
MA-5754	0,40	0,40	0,10	0,50	2,60 - 3,60	0,30	0,20	0,0003	0,15		0,05	0,15	Rest

Copper alloys

	Single values are maximum values (%)										Other Total	Cu
	Al	Si	Mn	Ni	Zn	Sn	Pb	Ti	Fe	P		
ML CuAl8	6,00 - 8,50	0,20	0,50		0,20		0,20				0,40	Rest
ML CuAl8Ni2	7,50 - 9,50	0,20	0,50 - 2,50	0,50 - 3,00	0,20		0,02		0,50 - 2,50		0,40	Rest
ML CuAl8Ni6	8,50 - 9,50	0,10	0,60 - 3,50	4,00 - 5,50	0,10		0,02		3,00 - 5,00		0,50	Rest
ML CuAl9Fe	8,50 - 11,00	0,10			0,02		0,02		1,50		0,50	Rest
ML CuMn13Al7	7,00 - 8,50	0,10	11,00 - 14,00	1,50 - 3,00	0,15		0,02		2,00 - 4,00		0,50	Rest
ML CuNi10Fe	0,03	0,20	0,50 - 1,50	9,00 - 11,00			0,02	0,20 - 0,50	0,50 - 2,00	0,007	0,40	Rest
ML CuNi30Fe		0,20	0,50 - 1,50	29,00 - 32,00			0,02	0,20 - 0,50	0,40 - 1,00	0,02	0,50	Rest
ML CuSi28L	0,02	2,80 - 3,00	0,75 - 0,95	0,05	0,10	0,05	0,01		0,10	0,05	0,50	Rest
ML CuSi3	0,01	2,80 - 4,00	0,75 - 1,50		0,20	0,20	0,02		0,30	0,02	0,40	Rest
ML CuSn	0,01	0,10 - 0,50	0,10 - 0,50	0,05		0,50 - 1,00	0,01		0,03	0,015	0,10	Rest
ML CuSn6	0,01				0,10	5,50 - 8,00	0,02		0,10	0,10 - 0,35	0,40	Rest

Safety data sheets may be obtained from www.migal.co!

Indicative tables

Fields of application and usage of MIGAL.CO consumables for identical or similar base materials

Aluminium alloys

Recommendation for the selection of welding consumables for base materials from wrought and cast aluminium alloys can be found in DIN EN 1011-4. An extract from this standard, especially for MIGAL.CO consumables, can be found underneath.

Broken down to the single base materials a material calculator can be found at www.migal.co.



Table 1 - Group division of consumables

Type	MIG WELD designation	Alloy designation	Chemical designation	Remarks
Type 1	MA-1450 MA-1070	S-1450 S-1070	Al99,5Ti Al 99,7	Ti reduces the formation of solidification cracks in the weld metal by means of corn fining.
Type 4	MA-4043 MA-4047	S-4043 A S-4047 A	AlSi5 AlSi12(A)	The Type 4 fillers oxidise during anodizing or by atmospheric influences and give a dark grey colour, whose intensity increases with increasing Si-content. Such fillers do not give a suitable colour adjustment to base materials from wrought alloys. These alloys are especially used to prevent solidification cracks in combination with high dilution and stiff clamping conditions.
Type 5	MA-5754 MA-5556 MA-5183 MA-5087 MA-5356	S-5754 S-5556 A S-5183 S-5087 S-5356	AlMg3 AlMg5Mn AlMg4,5Mn0,7(A) AlMg4,5MnZr AlMg5Cr(A)	In case that high corrosion resistance and colour adjustment are considered decisive then the Mg content of the filler metal shall be equal to the base metal. In case that a high yield strength and tensile strength are considered decisive then a filler metal with a Mg content between 4,5% to 5% shall be used. Cr and Zr reduce the susceptibility to solidification cracking by means of corn fining. Zr reduces the risk of hot cracking.

Remark: The Type numbers 1, 4 and 5 correspond with the first figure of the alloy designation.

Indicative tables

Table 2 - Selection of filler metals (The types of fillers are shown in table 1.)

Selection of the filler metals within each box (The figures in this table relate to the type numbers in table 1)

First line: Optimal physical properties
 Second line: Optimal corrosion resistance
 Third line: Optimal welding characteristic

Base material A											
Al	4 1 4										
AlMn	4 or 5 1 4	4 - 4									
AlMg < 1 % ^a	4 or 5 1 4	4 4 4	4 4 4								
AlMg 3 %	4 or 5 5 ^d 4 or 5	5 5 ^d 4	5 5 ^d 4	5 5 ^d 5							
AlMg 5 % ^b	5 5 5	5 5 5	5 5 5	5 5 5	5 5 5						
AlMgSi ^c	4 or 5 5 4	4 or 5 5 4	4 or 5 5 4	5 5 4	5 5 4	5 or 4 5 4					
AlZnMg	5 5 5	5 5 5	5 5 5	5 5 5	5 5 5	5 5 5	5 5 5				
AlSiCu < 1 % ^{e,f}	4 4 4	4 4 4	4 4 4	4 4 4	4 4 4	4 4 4	4 4 4	4 4 4	4 4 4		
AlSiMg ^e	4 4 4	4 4 4	4 4 4	4 4 4	4 4 4	4 4 4	4 4 4	4 4 4	4 4 4	4 4 4	
AlSiCu ^{e,f}	4 4 4	4 4 4	4 4 4	4 4 4	4 4 4	4 4 4	4 4 4	4 4 4	4 4 4	4 4 4	4 4 4
AlCu ^c	g	g	g	g	g	4 4 4	4 4 4	4 4 4	4 4 4	4 4 4	g g 4
Base material B	Al	AlMn	AlMg < 1 %	AlMg 3 %	AlMg 5 %	AlMgSi	AlZnMg	AlSiCu < 1 %	AlSiMg	AlSiCu	AlCu

Remark 1: In case that the base material alloys contain ≥ 2 % Mg and welding is done with filler metals of the type AlSi5 or AlSi12 (or when the base materials contain ≥ 2 % Si and welding is done with filler metals of the AlMg5 type) then sufficient Mg₂Si precipitations can be formed at the fusion line to give a brittle joint. These combinations are not recommended for dynamically or shock stressed structures. If the alloy combination can not be prevented then filler metals of the AlSi5 or AlMg5 type can be used.

Remark 2: The base materials are listed according to their chemical composition without reference to cast or wrought materials.

^a By welding without a filler metal these alloys are prone to solidification cracking. Precautions can be taken by the use of clamping devices or by increasing the Mg content in the weld up to more than 3%.

^b At certain environment conditions i.e. operation temperature $\geq 65^\circ\text{C}$ alloys with a Mg content of more than 3% may be prone to intercrystalline corrosion and/or stress corrosion. The susceptibility increases with rising Mg content and/or cold hardening. The effect of weld metal dilution should be taken into consideration.

^c These alloys are not recommended for welding without filler metals, due to their susceptibility of cold cracking.

^d The resistance against intercrystalline corrosion and stress corrosion of type 5 according to table 1 is increased when the Mg content does not exceed 3%. At environment conditions which may cause intercrystalline corrosion and/or stress corrosion, the Mg content of the filler metal should be similar to the base material or not significantly higher. Accordingly this must be obeyed for welding of the base materials with the referring filler metals.

^e The Silicon content of the filler metals should be selected in a way that they match the cast alloy of the base material as good as possible.

^f In case of die-casting the cast alloys are not weldable due the high gas content.

^g Not recommended – not suitable for the base metal.

Indicative tables

Fields of application and usage of MIGAL.CO consumables for identical or similar base materials

Copper alloys

Base metal	Filler metal							
	ML CuAl8	ML CuAl8Ni2	ML CuAl8Ni6	ML CuAl9Fe	ML CuMn13Al7	ML CuSi3	ML CuSn	ML CuSn6
2.0040 / OF-Cu						○	●	
2.0070 / SE-Cu						○	●	
2.1030 / CuSn8								●
2.0920 / CuAl8	●							
2.0076 / SW-Cu						○	●	
2.0090 / SF-Cu						○	●	
2.0205 / CuZn0,5						○	●	
2.0220 / CuZn5						●		○
2.0916 / CuAl5	●							
2.1522 / CuSi2Mn						●		
2.1525 / CuSi3Mn						●		
2.0928 / G-CuAl9	●							
CuAl8Fe3				●				
2.0460 / CuZn20Al	●							
2.0230 / CuZn10						●		○
2.0240 / CuZn15						●		○
2.1016 / CuSn4								●
2.0975 / CuAl10Ni		●						
2.0978 / CuAl11Ni6Fe5			●					
2.0980 / CuAl11Ni		●						
CuAl9Fe4Ni1				●				
2.0966 / CuAl10Ni5Fe4			●					
2.1020 / CuSn6								●

● suitable

○ suitable under certain conditions

Indicative tables

Fields of application and usage of MIGAL.CO consumables for identical or similar base materials

Stainless steel

The following table gives typical selections of welding consumables and basic designations for wire electrodes and filler wire / rods. For exact designations, please refer to the product datasheets of the individual products.

To address the welding job in question a number of factors have to be considered. The weld geometry and dilution, requirements for heat treatment in association with the welding process, service conditions and temperature, etc. These factors may dictate the choice of consumable beyond those recommended here.

For guidance on other steels or combination of steels not covered in these tables, please contact us.

Material number	Material designation	ASTM AISI UNS	Service temperature up to °C	1.4316 19.9.LSi	1.4332 24.13.LSi	1.4370 18.8.Mn	1.4430 19.12.3.LSi	1.4462 22.8.3.L	1.4551 19.9.NbSi	1.4576 19.12.3.NbSi
1.4000	X6Cr13	403		●	●	●			●	
1.4001	X7Cr14	429		●	●	●			●	
1.4002	X6CrAl13	405				●				
1.4003	X2CrNi12			●		●			●	
1.4006	X12Cr13	410		●		●			●	
1.4008	GX8CrNi13	CA 15		●		●			●	
1.4016	X6Cr17	430		●		●			●	
1.4021	X20Cr13	420		●		●			●	
1.4024	X15Cr13	410		●		●			●	
1.4027	GX20Cr14	A 217				●				
1.4034	X46Cr13					●				
1.4057	X17CrNi16-2	431				●				
1.4059	GX22CrNi17	A 743				●				
1.4113	X6CrMo17-1	434					●			●
1.4120	X20CrMo13						●			●
1.4120	GX20CrMo13						●			●
1.4122	X39CrMo17-1						●			●
1.4122	GX35CrMo17-1						●			●
1.4301	X5CrNi18-10	304		●					○	
1.4303	X4CrNi18-12	305		●					○	
1.4306	X2CrNi19-11	304L		●					○	
1.4308	GX5CrNi19-10			●					○	
1.4311	X2CrNiN18-10	304LN		●					○	

Indicative tables

Fields of application and usage of MIGAL.CO consumables for identical or similar base materials

Table continued

Material number	Material designation	ASTM AISI UNS	Service temperature up to °C	1.4316 19.9.LSi	1.4332 24.13.LSi	1.4370 18.8.Mn	1.4430 19.12.3.LSi	1.4462 22.8.3.L	1.4551 19.9.NbSi	1.4576 19.12.3.NbSi
1.4312	GX10CrNi18-8			●					○	
1.4362		S32304						●		
1.4401	X5CrNiMo17-12-2	316					●			○
1.4404	X2CrNiMo17-12-2	316L					●			○
1.4406	X2CrNiMoN17-11-2	316L					●			○
1.4408	GX5CrNiMo19-11-2						●			○
1.4409	GX2CrNiMo19-11-2						●			○
1.4417		S31500						●		
1.4429	X2CrNiMoN17-13-3	316LN					●			○
1.4435	X2CrNiMo18-14-3	317L					●			○
1.4436	X3CrNiMo17-13-3	S31600					●			○
1.4437	GX6CrNiMo18-12	S31600					●			○
1.4462	X2CrNiMoN22-5-3	S31803						●		
1.4541	X6CrNiTi18-10	321		○					●	
1.4550	X6CrNiNb18-10	347		○					●	
1.4552	GX5CrNiNb19-11	CF8C		○					●	
1.4571	X6CrNiMoTi17-12-2	316 Ti					○			●
1.4580	X6CrNiMoNb17-12-2	316 Cb					○			●
1.4581	GX5CrNiMoNb19-11-2						○			●
1.4583	X10CrNiMoNb18-12	316 Cb					○			●
1.4710 ²			850			○ ¹				
1.4712			850			○ ¹				
1.4713			800			○ ¹				
1.4724		405	850			○ ¹				
1.4825		A297 Gr. CF20	800			○ ¹			● ³	
1.4878		321	800			○ ¹			● ³	

● matching or similar alloyed filler metal

○ dissimilar or higher alloyed filler metal (service conditions must be approved)

¹ Austenitic weld metal with higher ductility; application in sulphur-containing environment or similar-colour requirement demands the usage of similar alloyed welding consumables

² weldability of base material is limited

³ for service temperatures up to 400°C

Indicative tables

Lengths of wires in meters ...

... for aluminium alloys at a specific weight of 2,7 g/cm³

Wire diameter [mm]	Weight [g/m]	Spool weight [kg]							
		0,5	2	6	7	18	40	80	140
0,8	1,36	368	1.474	4.421	5.158	13.263			
1,0	2,12	236	943	2.829	3.301	8.488			66.020
1,2	3,05	164	655	1.965	2.292	5.895	13.099	26.198	45.847
1,6	5,43	92	368	1.105	1.289	3.316	7.368	14.737	25.789
2,0	8,48	59	236	707	825	2.122	4.716		
2,4	12,21	41	164	491	573	1.474	3.275		

... for copper alloys at a specific weight of 8,9 g/cm³

Wire diameter [mm]	Weight [g/m]	Spool weight [kg]			
		3	5	15	200
0,8	4,47	671	1.118	3.353	
1,0	6,99	429	715	2.146	28.612
1,2	10,07	298	497	1.490	19.870
1,6	17,89	168	279	838	11.177
2,0	27,96	107	179	537	
2,4	40,26	75	124	373	

... for stainless steel wires at a specific weight of 7,8 g/cm³

Wire diameter [mm]	Weight [g/m]	Spool weight [kg]		
		15	150	300
0,8	3,92	3.826	38.258	76.517
1,0	6,13	2.449	24.485	48.971
1,2	8,82	1.700	17.004	34.007
1,6	15,68	956	9.565	19.129
2,0	24,50	612	6.121	12.243
2,4	35,29	425	4.251	8.502

... for nickel alloys at a specific weight of 8,5 g/cm³

Wire diameter [mm]	Weight [g/m]	Spool weight [kg]
		15
0,8	4,27	3.511
1,0	6,68	2.247
1,2	9,61	1.560
1,6	17,09	878
2,0	26,70	562
2,4	38,45	390

Approvals



Approvals

(Certificates may be downloaded from www.migal.co)

Aluminium alloys

Filler Metal	DNV-GL	ABS	DB	VdTUV	Bureau Veritas	Lloyds Register
MA-1070						
MA-1450						
MA-4043			•	•		
MA-4047						
MA-5087	•	•	•	•	•	•
MA-5183	•	•	•	•	•	•
MA-5356	•	•	•	•	•	•
MA-5754			•	•		
MA-5554						

Stainless steel

Filler metal	DNV-GL	DB	TUV MIG	TUV WIG
1.4316 19.9.LSi		•	•	•
1.4332 24.13.LSi				
1.4370 18.8.Mn		•	•	•
1.4430 19.12.3.LSi	•	•		•
1.4462 22.8.3.L	•		•	•
1.4551 19.9.NbSi		•	•	•
1.4576 19.12.3.NbSi		•	•	•

Aluminium Alloys

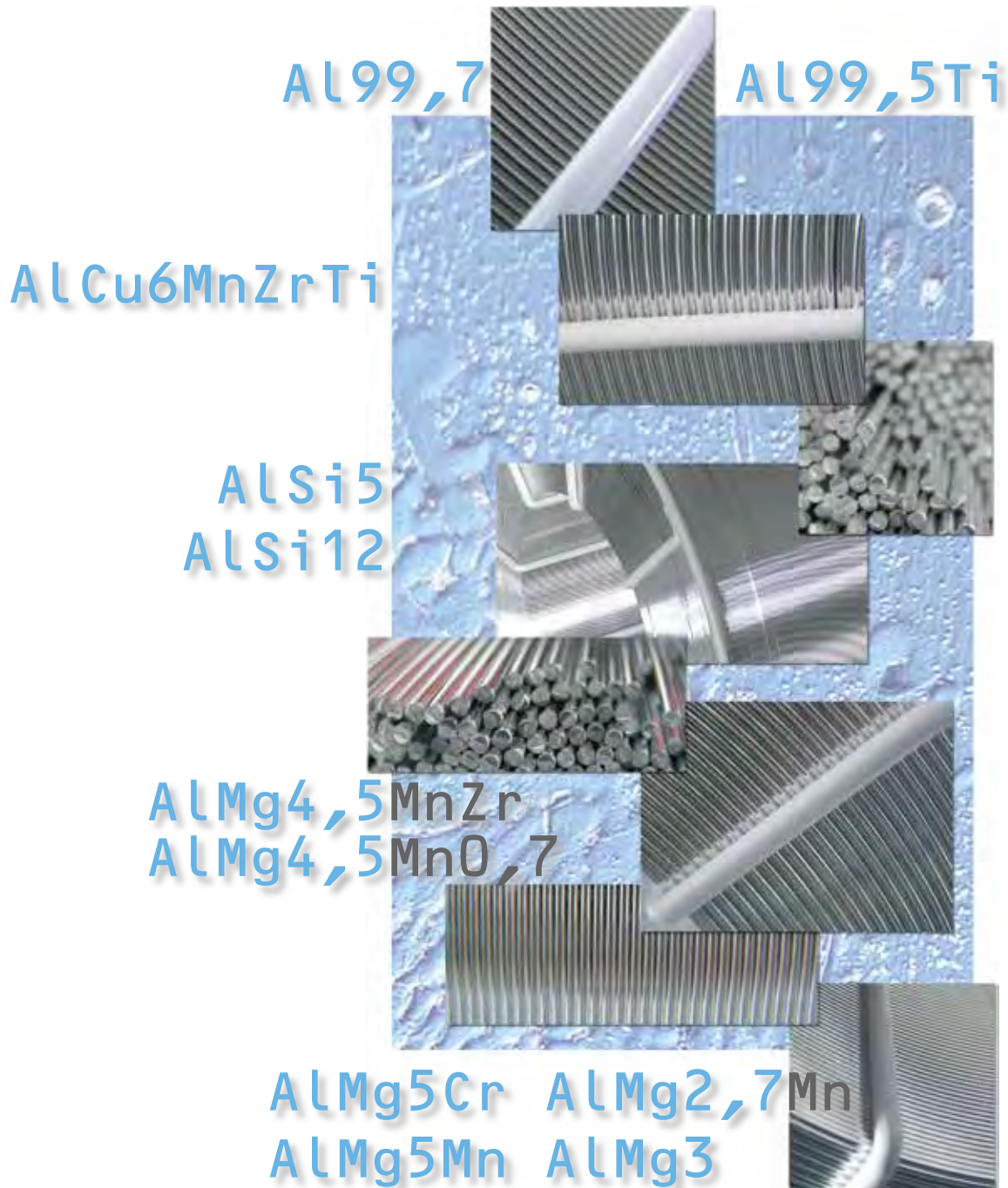

MA-1070 AL99,7

Rod/Wire electrode for Aluminium

Typical composition in %	Si < 0,20 Fe < 0,25 Cu < 0,04 Mn < 0,03 Mg < 0,03 Zn < 0,04 Be < 0,0003 Ti < 0,03 V < 0,05 Others < 0,03 Al min. 99,70
Classification	EN ISO 18273 S Al 1070 (Al99,7) Material No. 3.0259
Base materials	See page 15.
Remarks	Welding of pure aluminium requires special precaution due to the narrow melting range in order to prevent hotcracking and porosity. This alloy replaces ML 1050. Consider the technological application reference.
Physical properties (Approx. values)	Electrical conductivity [$S \cdot m/mm^2$] 34-36 Heat conductivity at 20°C [$W/(m \cdot K)$] 210-230 Linear heat extension coefficient (20-100°C) [$1/K$] $23,5 \cdot 10^{-6}$
Physical properties of pure weld metal (Approx. values)	0,2 % yield strength $R_{p0,2}$ [MPa] 20 Tensile strength R_m [MPa] 65 Elongation A_5 ($L_0=5d_0$) [%] 35 Test temperature [°C] 20
Welding position	PA, PB, PC, PF
Shielding gas	I1, I2, I3 (Argon, Helium or Argon/Helium-mixtures)
Polarity	MIG =+, TIG ~
Approvals	VdTÜV, DB
Dimensions Ø	MIG-wires [mm] 0,8; 1,0; 1,2; 1,6; 2,0; 2,4 TIG-rods [mm] 1,6; 2,0; 2,4; 3,2; 4,0; 5,0
Wire packagings	Spools Packaging units S 100 / 0,5 kg 20 spools = 10 kg (box) S 200 / 2 kg 4 spools = 8 kg (box) S 300 / 6 kg 56 spools = 336 kg (pallet) B 300 / BS 300 / 7 kg 56 spools = 392 kg (pallet) B 400 / 18 kg 28 spools = 504 kg (pallet) B 400 / 40 kg 15 spools = 600 kg (pallet)
Rod packagings	Box 10 kg Length 1.000 mm

MA-1450 AL99,5Ti

Rod/Wire electrode for Aluminium

Typical composition in %	Si < 0,25 Fe < 0,40 Cu < 0,05 Mn < 0,05 Mg < 0,05 Zn < 0,07 Be < 0,0003 Ti 0,10-0,20 Others < 0,03 Al min. 99,50
Classification	EN ISO 18273 S Al 1450 (Al99,5Ti) Material No. 3.0805
Base materials	See page 15.
Remarks	Welding of pure aluminium requires special precaution due to the narrow melting range in order to prevent hotcracking and porosity. Grain refinement in the weld metal resulting from the addition of Ti. Consider the technological application reference.
Physical properties (Approx. values)	Electrical conductivity [$S \cdot m/mm^2$] min. 35 Heat conductivity at 20°C [$W/(m \cdot K)$] 210-230 Linear heat extension coefficient (20-100°C) [$1/K$] $23,5 \cdot 10^{-6}$
Physical properties of pure weld metal (Approx. values)	0,2 % yield strength $R_{p0,2}$ [MPa] 20 Tensile strength R_m [MPa] 65 Elongation A_5 ($L_0=5d_0$) [%] 35 Test temperature [°C] 20
Welding position	PA, PB, PC, PF
Shielding gas	1, I2, I3 (Argon, Helium or Argon/Helium-mixtures)
Polarity	MIG =+, TIG ~
Approvals	VdTÜV, DB
Dimensions Ø	MIG-wires [mm] 0,8; 1,0; 1,2; 1,6; 2,0; 2,4 TIG-rods [mm] 1,6; 2,0; 2,4; 3,2; 4,0; 5,0
Wire packagings	Spools Packaging units S 100 / 0,5 kg 20 spools = 10 kg (box) S 200 / 2 kg 4 spools = 8 kg (box) S 300 / 6 kg 56 spools = 336 kg (pallet) B 300 / BS 300 / 7 kg 56 spools = 392 kg (pallet) B 400 / 18 kg 28 spools = 504 kg (pallet) B 400 / 40 kg 15 spools = 600 kg (pallet)
Rod packagings	Box 10 kg Length 1.000 mm

MA-2319 AlCu6MnZrTi

Rod/Wire electrode for Aluminium

Typical composition in %	Si < 0,20 Fe < 0,30 Cu 5,80-6,80 Mn 0,20-0,40 Mg < 0,02 V 0,05-0,15 Zn < 0,10 Zr 0,10-0,25 Be < 0,0003 Ti 0,10-0,20 Others < 0,05 Others total < 0,15
Classification	EN ISO 18273 S Al 2319 (AlCu6MnZrTi) AWS A 5-10 ER 2319
Base materials	AlCu6Mn
Remarks	This alloy is mainly used in the air- and spacecraft industry. Consider the technological application reference.
Physical properties of pure weld metal (Approx. values)	0,2 % yield strength $R_{p0,2}$ [MPa] 180 Tensile strength R_m [MPa] 240 Elongation A_5 ($L_0=5d_0$) [%] approx. 3 Test temperature [°C] 20
Welding position	PA, PB, PC, PF
Shielding gas	I1, I2, I3 (Argon, Helium or Argon/Helium-mixtures)
Polarity	MIG =+, TIG ~
Approvals	on request
Dimensions Ø	MIG-wires [mm] 0,8; 1,0; 1,2; 1,6; 2,0; 2,4 TIG-rods [mm] 1,6; 2,0; 2,4; 3,2; 4,0; 5,0
Wire packagings	Spools Packaging units S 100 / 0,5 kg 20 spools = 10 kg (box) S 200 / 2 kg 4 spools = 8 kg (box) S 300 / 6 kg 56 spools = 336 kg (pallet) B 300 / BS 300 / 7 kg 56 spools = 392 kg (pallet) B 400 / 18 kg 28 spools = 504 kg (pallet) B 400 / 40 kg 15 spools = 600 kg (pallet) Eco-drum / 80 kg 2 drums = 160 kg (pallet) Jumbo-drum / 140 kg 2 drums = 280 kg (pallet)
Rod packagings	Box 10 kg Length 1.000 mm

MA-4043 AlSi5

Rod/Wire electrode for Aluminium

Typical composition in %	Si 4,50-5,50 Fe < 0,60 Cu < 0,30 Mn < 0,15 Mg < 0,20 Zn < 0,10 Be < 0,0003 Ti < 0,15 Others < 0,05 Others total < 0,15
Classification	EN ISO 18273 S Al 4043A (AlSi5(A)) Material No. 3.2245 AWS A 5-10 ER 4043
Base materials	See page 15.
Remarks	This alloy is particularly used to prevent solidification cracks in connection with high dilution and clamp conditions. Anodizing gives dark gray colours and is not recommended. The weld pool is very fluid. Consider the technological application reference.
Physical properties of pure weld metal (Approx. values)	0,2 % yield strength $R_{p0,2}$ [MPa] 40 Tensile strength R_m [MPa] 120 Elongation A_5 ($L_0=5d_0$) [%] 8 Test temperature [°C] 20
Welding position	PA, PB, PC, PF
Shielding gas	I1, I2, I3 (Argon, Helium or Argon/Helium-mixtures)
Polarity	MIG =+, TIG ~
Approvals	DB, VdTÜV
Dimensions Ø	MIG-wires [mm] 0,8; 1,0; 1,2; 1,6; 2,0; 2,4 TIG-rods [mm] 1,6; 2,0; 2,4; 3,2; 4,0; 5,0
Wire packagings	Spools Packaging units S 100 / 0,5 kg 20 spools = 10 kg (box) S 200 / 2 kg 4 spools = 8 kg (box) S 300 / 6 kg 56 spools = 336 kg (pallet) B 300 / BS 300 / 7 kg 56 spools = 392 kg (pallet) B 400 / 18 kg 28 spools = 504 kg (pallet) B 400 / 40 kg 15 spools = 600 kg (pallet) Eco-drum / 80 kg 2 drums = 160 kg (pallet) Jumbo-drum / 140 kg 2 drums = 280 kg (pallet)
Rod packagings	Box 10 kg Length 1.000 mm

MA-4047 ALSi12

Rod/Wire electrode for Aluminium

Typical composition in %	Si 11,00-13,00 Fe < 0,60 Cu < 0,30 Mn < 0,15 Mg < 0,10 Zn < 0,20 Be < 0,0003 Ti < 0,15 Others < 0,05 Others total < 0,15
Classification	EN ISO 18273 S Al 4047A (AlSi12(A)) Material No. 3.2585 AWS A 5-10 ER 4047
Base materials	See page 15.
Remarks	This alloy is particularly used to prevent solidification cracks in connection with high dilution and clamp conditions. Anodizing gives dark gray colours and is not recommended. The weld pool is very fluid. Consider the technological application reference.
Physical properties of pure weld metal (Approx. values)	0,2 % yield strength $R_{p0,2}$ [MPa] 60 Tensile strength R_m [MPa] 130 Elongation A_5 ($L_0=5d_0$) [%] 5 Test temperature [°C] 20
Welding position	PA, PB, PC, PF
Shielding gas	I1, I2, I3 (Argon, Helium or Argon/Helium-mixtures)
Polarity	MIG =+, TIG ~
Approvals	VdTÜV, DB
Dimensions Ø	MIG-wires [mm] 0,8; 1,0; 1,2; 1,6; 2,0; 2,4 TIG-rods [mm] 1,6; 2,0; 2,4; 3,2; 4,0; 5,0
Wire packagings	Spools Packaging units S 100 / 0,5 kg 20 spools = 10 kg (box) S 200 / 2 kg 4 spools = 8 kg (box) S 300 / 6 kg 56 spools = 336 kg (pallet) B 300 / BS 300 / 7 kg 56 spools = 392 kg (pallet) B 400 / 18 kg 28 spools = 504 kg (pallet) B 400 / 40 kg 15 spools = 600 kg (pallet) Eco-drum / 80 kg 2 drums = 160 kg (pallet) Jumbo-drum / 140 kg 2 drums = 280 kg (pallet)
Rod packagings	Box 10 kg Length 1.000 mm

MA-5087 AlMg4,5MnZr

Rod/Wire electrode for Aluminium

Typical composition in %	Si < 0,25 Fe < 0,40 Cu < 0,05 Mn 0,70-1,10 Mg 4,50-5,20 Cr 0,05-0,25 Zn < 0,25 Be < 0,0003 Ti < 0,15 Zr 0,10-0,20 Others < 0,05 Others total < 0,15
Classification	EN ISO 18273 S Al 5087 (AlMg4,5MnZr(A)) Material No. 3.3546
Base materials	See page 15.
Remarks	Zirconium micro alloyed. The weld is not susceptible to hot cracking. Particularly advantageous for complicated weldments involving clamp conditions. Consider the technological application reference.
Physical properties of pure weld metal (Approx. values)	0,2 % yield strength $R_{p0,2}$ [MPa] 125 Tensile strength R_m [MPa] 275 Elongation A_5 ($L_0=5d_0$) [%] 17 Test temperature [°C] 20
Welding position	PA, PB, PC, PF
Shielding gas	I1, I2, I3 (Argon, Helium or Argon/Helium-mixtures)
Polarity	MIG =+, TIG ~
Approvals	VdTÜV, DB, DNV-GL, Bureau Veritas, Lloyds Register
Dimensions Ø	MIG-wires [mm] 0,8; 1,0; 1,2; 1,6; 2,0; 2,4 TIG-rods [mm] 1,6; 2,0; 2,4; 3,2; 4,0; 5,0
Wire packagings	Spools Packaging units S 100 / 0,5 kg 20 spools = 10 kg (box) S 200 / 2 kg 4 spools = 8 kg (box) S 300 / 6 kg 56 spools = 336 kg (pallet) B 300 / BS 300 / 7 kg 56 spools = 392 kg (pallet) B 400 / 18 kg 28 spools = 504 kg (pallet) B 400 / 40 kg 15 spools = 600 kg (pallet) Eco-drum / 80 kg 2 drums = 160 kg (pallet) Jumbo-drum / 140 kg 2 drums = 280 kg (pallet)
Rod packagings	Box 10 kg Length 1.000 mm

MA-5183 ALMg4,5Mn0,7

Rod/Wire electrode for Aluminium

Typical composition in %	Si < 0,40 Fe < 0,40 Cu < 0,10 Mn 0,50-1,00 Mg 4,30-5,20 Cr 0,05-0,25 Zn < 0,25 Be < 0,0003 Ti < 0,15 Others < 0,05 Others total < 0,15
Classification	EN ISO 18273 S Al 5183 (AlMg4,5Mn0,7(A)) Material No. 3.3548 AWS A 5-10 ER 5183
Base materials	See page 15.
Remarks	Seawater resistant weld metal. Consider the technological application reference.
Physical properties of pure weld metal (Approx. values)	0,2 % yield strength $R_{p0,2}$ [MPa] 125 Tensile strength R_m [MPa] 275 Elongation A_5 ($L_0=5d_0$) [%] 17 Test temperature [°C] 20
Welding position	PA, PB, PC, PF
Shielding gas	I1, I2, I3 (Argon, Helium or Argon/Helium-mixtures)
Polarity	MIG =+, TIG ~
Approvals	VdTÜV, DB, DNV-GL, Bureau Veritas, Lloyds Register
Dimensions Ø	MIG-wires [mm] 0,8; 1,0; 1,2; 1,6; 2,0; 2,4 TIG-rods [mm] 1,6; 2,0; 2,4; 3,2; 4,0; 5,0
Wire packagings	Spools Packaging units S 100 / 0,5 kg 20 spools = 10 kg (box) S 200 / 2 kg 4 spools = 8 kg (box) S 300 / 6 kg 56 spools = 336 kg (pallet) B 300 / BS 300 / 7 kg 56 spools = 392 kg (pallet) B 400 / 18 kg 28 spools = 504 kg (pallet) B 400 / 40 kg 15 spools = 600 kg (pallet) Eco-drum / 80 kg 2 drums = 160 kg (pallet) Jumbo-drum / 140 kg 2 drums = 280 kg (pallet)
Rod packagings	Box 10 kg Length 1.000 mm

MA-5356 ALMg5Cr

Rod/Wire electrode for Aluminium

Typical composition in %	Si < 0,25 Fe < 0,40 Cu < 0,10 Mn 0,05-0,20 Mg 4,50-5,50 Cr 0,05-0,20 Zn < 0,10 Be < 0,0003 Ti 0,06-0,20 Others < 0,05 Others total < 0,15
Classification	EN ISO 18273 S Al 5356 (AlMg5Cr(A)) Material No. 3.3556AWS A 5-10 ER 5356
Base materials	See page 15.
Remarks	The weld metal is sea water resistant. Suitable for anodizing when matching colours are required. Consider the technological application reference.
Physical properties of pure weld metal (Approx. values)	0,2 % yield strength $R_{p0,2}$ [MPa] 110 Tensile strength R_m [MPa] 240 Elongation A_5 ($L_0=5d_0$) [%] 17 Test temperature [°C] 20
Welding position	PA, PB, PC, PF
Shielding gas	I1, I2, I3 (Argon, Helium or Argon/Helium-mixtures)
Polarity	MIG =+, TIG ~
Approvals	VdTÜV, DB, DNV-GL, Bureau Veritas, Lloyds Register
Dimensions Ø	MIG-wires [mm] 0,8; 1,0; 1,2; 1,6; 2,0; 2,4 TIG-rods [mm] 1,6; 2,0; 2,4; 3,2; 4,0; 5,0
Wire packagings	Spools Packaging units S 100 / 0,5 kg 20 spools = 10 kg (box) S 200 / 2 kg 4 spools = 8 kg (box) S 300 / 6 kg 56 spools = 336 kg (pallet) B 300 / BS 300 / 7 kg 56 spools = 392 kg (pallet) B 400 / 18 kg 28 spools = 504 kg (pallet) B 400 / 40 kg 15 spools = 600 kg (pallet) Eco-drum / 80 kg 2 drums = 160 kg (pallet) Jumbo-drum / 140 kg 2 drums = 280 kg (pallet)
Rod packagings	Box 10 kg Length 1.000 mm

MA-5554 ALMg2,7Mn

Rod/Wire electrode for Aluminium

Typical composition in %	Si < 0,25 Fe < 0,40 Cu < 0,10 Mn 0,50-1,00 Mg 2,40-3,00 Cr 0,05-0,20 Zn < 0,25 Be < 0,0003 Ti 0,05-0,20 Others < 0,05 Others total < 0,15
Classification	EN ISO 18273 S Al 5554 (AlMg2,7Mn) Material No. 3.3538 AWS A 5-10 ER 5554
Base materials	See page 15.
Remarks	This alloy was developed for applications at high temperatures and for resistance against intergranular corrosion. Joining of the base metal 5454 with alloys of the 6000 range is possible. The weld metal is sea water resistant. Consider the technological application reference.
Physical properties of pure weld metal (Approx. values)	0,2 % yield strength $R_{p0,2}$ [MPa] 100 Tensile strength R_m [MPa] 215 Elongation A_5 ($L_0=5d_0$) [%] 17 Test temperature [°C] 20
Welding position	PA, PB, PC, PF
Shielding gas	I1, I2, I3 (Argon, Helium or Argon/Helium-mixtures)
Polarity	MIG =+, TIG ~
Approvals	VdTÜV, DB
Dimensions Ø	MIG-wires [mm] 0,8; 1,0; 1,2; 1,6; 2,0; 2,4 TIG-rods [mm] 1,6; 2,0; 2,4; 3,2; 4,0; 5,0
Wire packagings	Spools Packaging units S 100 / 0,5 kg 20 spools = 10 kg (box) S 200 / 2 kg 4 spools = 8 kg (box) S 300 / 6 kg 56 spools = 336 kg (pallet) B 300 / BS 300 / 7 kg 56 spools = 392 kg (pallet) B 400 / 18 kg 28 spools = 504 kg (pallet) B 400 / 40 kg 15 spools = 600 kg (pallet) Eco-drum / 80 kg 2 drums = 160 kg (pallet) Jumbo-drum / 140 kg 2 drums = 280 kg (pallet)
Rod packagings	Box 10 kg Length 1.000 mm

MA-5556 AlMg5Mn

Rod/Wire electrode for Aluminium

Typical composition in %	Si < 0,25 Fe < 0,40 Cu < 0,10 Mn 0,60-1,00 Mg 5,00-5,50 Cr 0,05-0,20 Zn < 0,20 Be < 0,0003 Ti 0,05-0,20 Others < 0,05 Others total < 0,15
Classification	EN ISO 18273 S Al 5556A (AlMg5Mn) AWS A 5-10 ER 5556
Base materials	See page 15.
Remarks	Consider the technological application reference.
Physical properties of pure weld metal (Approx. values)	0,2 % yield strength $R_{p0,2}$ [MPa] 125 Tensile strength R_m [MPa] 275 Elongation A_5 ($L_0=5d_0$) [%] 17 Test temperature [°C] 20
Welding position	PA, PB, PC, PF
Shielding gas	I1, I2, I3 (Argon, Helium or Argon/Helium-mixtures)
Polarity	MIG =+, TIG ~
Approvals	on request
Dimensions Ø	MIG-wires [mm] 0,8; 1,0; 1,2; 1,6; 2,0; 2,4 TIG-rods [mm] 1,6; 2,0; 2,4; 3,2; 4,0; 5,0
Wire packagings	Spools Packaging units S 100 / 0,5 kg 20 spools = 10 kg (box) S 200 / 2 kg 4 spools = 8 kg (box) S 300 / 6 kg 56 spools = 336 kg (pallet) B 300 / BS 300 / 7 kg 56 spools = 392 kg (pallet) B 400 / 18 kg 28 spools = 504 kg (pallet) B 400 / 40 kg 15 spools = 600 kg (pallet) Eco-drum / 80 kg 2 drums = 160 kg (pallet) Jumbo-drum / 140 kg 2 drums = 280 kg (pallet)
Rod packagings	Box 10 kg Length 1.000 mm

MA-5754 ALMg3

Rod/Wire electrode for Aluminium

Typical composition in %	Si < 0,40 Fe < 0,40 Cu < 0,10 Mn < 0,50 Mg 2,60-3,60 Cr < 0,30 Zn < 0,20 Be < 0,0003 Ti < 0,15 Others < 0,05 Others total < 0,15
Classification	EN ISO 18273 S Al 5754 (AlMg3) Material No. 3.3536
Base materials	See page 15.
Remarks	The weld metal is sea water resistant. Suitable for anodizing when matching colours are required. Consider the technological application reference.
Physical properties of pure weld metal (Approx. values)	0,2 % yield strength $R_{p0,2}$ [MPa] 80 Tensile strength R_m [MPa] 190 Elongation A_5 ($L_0=5d_0$) [%] 20 Test temperature [°C] 20
Welding position	PA, PB, PC, PF
Shielding gas	I1, I2, I3 (Argon, Helium or Argon/Helium-mixtures)
Polarity	MIG =+, TIG ~
Approvals	on request
Dimensions Ø	MIG-wires [mm] 0,8; 1,0; 1,2; 1,6; 2,0; 2,4 TIG-rods [mm] 1,6; 2,0; 2,4; 3,2; 4,0; 5,0
Wire packagings	Spools Packaging units S 100 / 0,5 kg 20 spools = 10 kg (box) S 200 / 2 kg 4 spools = 8 kg (box) S 300 / 6 kg 56 spools = 336 kg (pallet) B 300 / BS 300 / 7 kg 56 spools = 392 kg (pallet) B 400 / 18 kg 28 spools = 504 kg (pallet) B 400 / 40 kg 15 spools = 600 kg (pallet) Eco-drum / 80 kg 2 drums = 160 kg (pallet) Jumbo-drum / 140 kg 2 drums = 280 kg (pallet)
Rod packagings	Box 10 kg Length 1.000 mm

Application reference

Application reference to gas shielded arc welding of aluminium

The use of aluminium and its alloys increases continuously all over the world. In the field of mobility an over proportional increase and further substitution of steel in particular, but not only, will occur in a near future. Increasing cost of energy make lightweight design more economical than ever. As a consequence, constructors switch from steel to aluminium and new manufacturers immediately start with aluminium.

As production processes and applied terminology often differ only slightly from steel, basic mistakes are commonly made and lead to expensive rework, reject and delay. As a matter of fact, some properties of aluminium are just opposite to steel and knowledge about these is essential for safe manufacturing.

Physical properties of chemically clean aluminium (compared to iron)

Properties	Unit	Al	Fe	Relation
Atomic weight	[g/Mol]	26,98	55,84	≈ 1 against 2
Crystal lattice		cubically face-centred	cubically body-centred	
Density	[g/cm ³]	2,70	7,87	≈ 1 against 3
Elasticity	[Gpa]	67	210	≈ 1 against 3
Expansion coefficient	[1/K]	24 · 10 ⁻⁶	12 · 10 ⁻⁶	≈ 2 against 1
R _{p0,2}	[MPa]	≈ 10	≈ 100	≈ 1 against 10
Tensile strength R _m	[MPa]	≈ 50	≈ 200	≈ 1 against 4
Specific heat	[J/kg·K]	≈ 890	≈ 460	≈ 2 against 1
Heat of fusion	[J/g]	≈ 390	≈ 272	≈ 1,5 against 1
Melting temperature	[°C]	660	1536	≈ 1 against 2,5
Heat conductivity	[W/m·K]	235	75	≈ 3 against 1
Electrical conductivity	[m/Ω·mm ²]	38	≈ 10	≈ 4 against 1
Oxides		Al ₂ O ₃	FeO / Fe ₂ O ₃ / Fe ₃ O ₄	
Melting temperature of oxides	[°C]	2050	1400 / 1455 / 1600	Fe similar to metal; Al three times as much
Density of oxides	[g/cm ³]	3,89	5,7 / 5,24 / ≈ 5,0	Iron oxides are lighter than metal; Al oxides are heavier

Table: Physical properties of aluminium compared to iron

Effects of the differences between the physical properties of steel to aluminium on fusion welding

The differences in density, modulus of elasticity and strength are hardly relevant for welding but most certainly for the design of structures.

The high electrical conductivity of aluminium may lead to arc striking problems and the high thermal conductivity to a lack of fusion at the beginning of the weld and to forward moving welding heat. These aspects are discussed in this article. The high heat conductivity may also lead to overheating of fixtures and to dimensional deviations, which require a more stable

Application reference

design, and probably additional cooling of such devices. In general high heat conductivity and a high coefficient of expansion give more deviation than compared to steel and must be considered in design and in the construction of welding fixtures.

Special attention has to be paid to the oxide layer and to the solubility of hydrogen.

Oxide layer

When exposed to the atmosphere, aluminium immediately forms an oxide layer, which basically consists of amorphous Al_2O_3 in two partial layers on top of each other, namely

- a nearly pore free base- or barrier layer of amorphous aluminium oxide and
- a porous and hydrated cover layer with low crystalline contents of Al-hydroxides and bayerite.

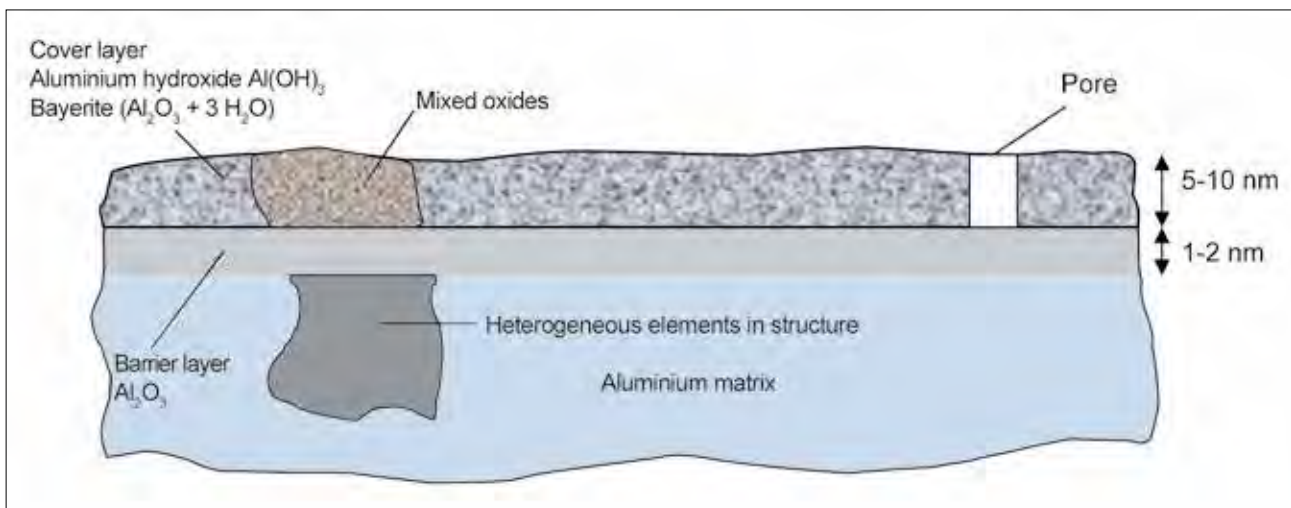

Figure: Schematic structure of a natural oxide layer

The thickness of the oxide layer increases with time, temperature and availability of oxygen. Even though the oxide layer is very tight, has a melting temperature of 2300°C and protects the aluminium surface from further corrosion, it can also be porous and pick up humidity.

The surface condition of aluminium influences MIG and TIG welding in the following aspects:

- The arc stability (a stable arc requires the presence of aluminium oxide)
- The geometry of the arc focal point
- The voltage drop in the arc and therefore the arc length
- The geometry of the weld
- The quality of the weld
- The reproducibility of the process in particular with automatic welding

Due to the extremely small thickness within few nanometres of the oxide layer, it is hardly measurable under practical

Application reference

conditions. Hence, the only remaining possibility to obtain a defined oxide layer is to remove the old layer completely by chemical processes (pickling) and by storing under controlled conditions (environment and time).

Further remarkable is the fact that the density of aluminium oxide in comparison to the metal itself is higher. With iron (steel) the oxides have a lower weight than the metal and therefore float on the surface of the molten pool. With aluminium the oxide sinks into the molten metal and may cause oxide inclusions.

Solubility of hydrogen

Amongst all gases only hydrogen can be solved in aluminium. Compared to the solubility of gases in iron alloys, however, the quantity is rather low.

The solubility of hydrogen in aluminium depends on the content of alloys and on the temperature. The solved quantity furthermore depends on the availability of hydrogen, which is usually given as the partial pressure and indicated in millilitres of the solved gas per 100 grams of metal. (1013 mbar and 0° C, 1ppm = 1.1124 ml/100 g).

As the solubility of hydrogen in aluminium suddenly decreases at a temperature of approximately 600° C during cooling, it often comes to porosity caused by frozen gas bubbles. With pure aluminium the tendency to porosity is most serious, whereas it is lower with alloys. This is due to a smaller lap in the solubility of hydrogen.

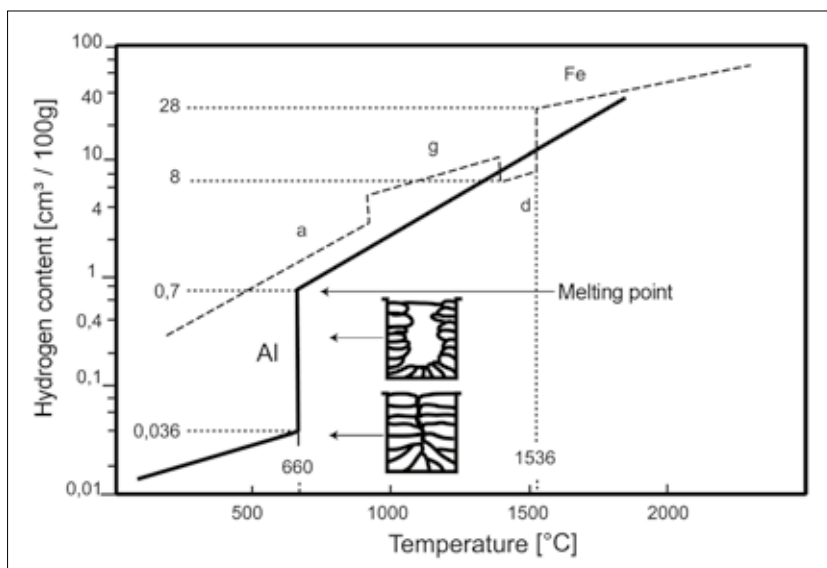

Figure: Solubility of hydrogen in aluminium and iron

These circumstances lead to the fact that the presence of porosity with MIG welding of aluminium is nearly unavoidable.

Pores have negative implications on the static and dynamic strength of welded joints and can be disturbing anyway. Machining the surfaces opens pores, which don't look nice and may reduce the adhesion of paint.

Inspectors have trouble to determine the level of acceptable porosity and both manufacturers and customers consider it as just poor work.

The basic solution to this problem is to keep the level of available hydrogen as low as possible. Generally, a hydrogen content of approximately 0.2 to 0.3 ml/100 g is considered to be the maximum permitted level in order to get low porosity. This value is quite frequently exceeded under practical conditions. Sources of hydrogen are base material, filler material, shielding gas and atmosphere. Clean storage and manufacturing conditions, preparation of the surfaces and prevention of all other sources of hydrogen is the most important rule.

Application reference

Surface treatment prior to welding

Due to the above mentioned circumstances, the surface treatment of base metals and filler wires plays a much bigger role than for instance with steel. The question if cleaning prior to welding is necessary can only be answered in one way: If the target is low porosity, high strength and constant welding joints, then thorough cleaning according to tested, fixed and reproducible processes is necessary. We have put together some basic rules for storage, cleaning, joint preparation and welding.

Storage and handling

Base materials

Sheets and profiles are to be stored vertically and with sufficient distance in order to get air circulation and to prevent contact points to each other. The storage areas must be covered and preferably heated whereas the temperature should be constant. Controlled humidity would be a positive option.

Filler materials

Heated storage premises with constant temperature and if possible controlled humidity as well is of great importance. Prior to welding the filler metals should be stored in the same environment as the base materials without opening the boxes in order to get the same temperature. Protection against dust and any other pollution must be ensured at any time.

Condensation

The influence of atmospheric humidity and temperature may alter the conditions of fabrication during different seasons significantly. Just like humidity condenses on a glass of beer, this can happen on aluminium surfaces as well. The difference of temperature between air and metal and the humidity are the responsible parameters. The following table shows the dew points at different temperature differences and humidity in some examples. At www.migal.co a dew point calculator can be found.

$(T_{\text{air}} - T_{\text{metal}})^{\circ}$	Relative humidity	$(T_{\text{air}} - T_{\text{metal}})^{\circ}$	Relative humidity
$^{\circ}\text{C}$	%	$^{\circ}\text{C}$	%
0	100	12	44
1	93	13	41
2	87	14	38
3	81	15	36
4	75	16	34
5*	70*	18	30
6	66	20	26
7	61	22	23
8	57	24	21
9	53	26	18
10	50	28	16
11	48	30	14

* Example: At a relative humidity of 70 %, water condenses on a metal surface with a temperature difference of 5° C only. Condensation must be avoided in any case.

Table: Condensation of water depending on the temperature difference between metal and air

Application reference

Joint preparation

Plasma cutting

Attention must be paid to an utmost focused arc and the lowest possible heat input. Especially with alloys of the 2XXX, 6XXX and 7XXX groups cracking may occur in the heat affected zone and machining of the cutting edge of up to 3 mm and more may be required. Alloys of the groups 1XXX, 3XXX and 5XXX can usually be welded without any post treatment.

Machining

Turning, milling or other metal-cutting processes are most suitable. Lubricants or cooling liquids must not be used, however, and the tools need to have sharp edges to prevent smearing of the metal. Particularly suitable are milling rings and weld root opener from MIGAL.CO, for more information see www.migal.co/milling-substitutes-grinding

For sawing and grinding only products recommended by their manufacturers shall be used.

For brushing, take care to use stainless steel brushes to prevent inclusions of carbon steel into the base material. The bristle wire diameter of the brush should be between 0.1 and 1.25 mm for the softer aluminium alloys and between 0.25 and 0.4 mm for the harder alloys. If the wire is too thin it often bends at its ends and therefore is no longer able to remove the impurities. It rather gives a smearing effect. If the wire is too thick it leads to flutes in the material. Similar considerations are to be taken with shot blasting. Compressed air tools should exhaust to the back in order to prevent contamination with oil.

Chemical cleaning

The cleaning processes should be applied short before welding. Possible cleaning methods are pickling in alkaline solutions and the application of hydrocarbon solvents (alcohol, acetone). Despite high costs, pickling is preferable. Solvents are prohibited in many cases for reasons of work safety as solvent residuals may produce gases and fumes, which may be harmful to health.

Gas Metal Arc Welding of aluminium

General Information

MIG (Metal Inert Gas) welding with a gas metal arc in shielded atmosphere is the most commonly used welding process for aluminium. Beside this process, there is TIG (Tungsten Inert Gas) welding with a tungsten arc in shielding atmosphere employed for thin aluminium sheet constructions where the metal has a thickness below 2 mm. However, the evolution of generators with pulsed power supply also permits the welding of thin sheets.

In the MIG welding process, the wire is used as the electrode and at the same time as the consumable. Throughout the wire consumption, the wire is automatically unwound down to the welding handle. Gas metal arc welding is done with direct current (electrode positive) and ensures the pickling and fusion of the wire. The parts to be welded are bound to a negative pole.

In the TIG welding process, the electric arc is produced between a tungsten electrode and the part to be welded. The filler metal fed by hand feeds the melt. Gas tungsten arc welds are made with alternating current. Both processes, MIG and TIG welding, are covered by the sign MSG (Metal Shielding Gas). MIG welding is easily automated (robot welding) which is not as easy with Tig welding. Due to this fact and the generally higher deposit rate of Mig welding, it will show an increasing significance in the future.

Application reference

Filler metals

The selection of the proper filler metal can be made with the table in this catalogue or the material calculator at www.migal.co. These aids cannot consider all constructional and metallurgical characteristics and the conditions of the base metal. Due to this reason separate investigations and trials are required before production in many cases. The quality and the stability of the process are in an immediate relation with the quality of the filler metal.

MIG welding

Filler metals from MIGAL.CO have an outstanding purity and enjoy a special surface treatment. With Mig welding, the filler wire is the electrode at the same time. The wire is fed from the spool through a wire feed system into a hose pack and finally through the contact tip by means of an automated system. The welding current is given to the electrode only short before the arc.

The gliding characteristics and the purity of the surface are essential for trouble free wire feeding. MIGAL.CO wires are optimised for this purpose and provide a stable and safe arc ignition as well as low friction in the liners. A favourable side effect of the surface purity is the low formation of welding fumes, which occurs substantially by evaporation of surface impurities. Welds made with wires from MIGAL.CO show lowest porosity and highest strength.

The reduced formation of welding fumes was proved by investigations of the Institute for occupational health in St. Augustin, Germany, with wires of the alloy AlSi5 Ø 1.2 mm in comparison to other commercially available products.

The wire feeder unit must be equipped according to the manufacturers specifications. This concerns the shape of wire feed rolls, the use of plastic or Teflon liners and the choice of contact tips.

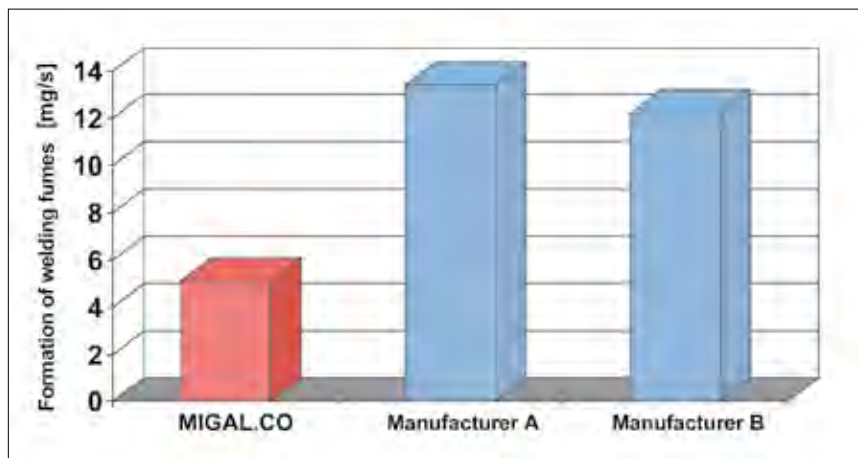

Figure: Comparison of wire electrodes regarding the formation of welding fumes

In opposite to steel wires, the inner diameter of the contact tip bore must be larger. For instance, it has been proved that a bore diameter of 1.6 mm is suitable for a 1.2 mm wire diameter. It is most important to prevent the wire from rubbing and getting scratches from any metal part on its way from the spool to the electric arc and to ensure its surface remains undamaged. Furthermore, it has to be considered that pure aluminium and aluminium-silicon alloys are softer than aluminium-magnesium alloys and that the liner should not exceed 3 m. With aluminium-magnesium alloys a length of 4 m should be possible. With mechanised or robotic welding processes a hose pack length of 1.5 to 2 m should not be exceeded and in the full interest of a trouble free welding process, a pulled wire feeding system (wire drive in the welding torch) or combined systems (push-pull) are recommended.

Application reference

Wire feeding

Wire feed systems for GMAW-welding machines were initially developed to transport steel wires as well as most other design criteria has been derived from steel welding. Steel wires generally have good gliding characteristics and high stiffness. Neither is true for aluminium and this is particularly difficult for the feeding of AISI5 and pure aluminium wires. In no case, aluminium wire should be pulled through a liner as this leads to a self-amplifying braking effect.

While it is hardly necessary to pull the wire through a liner when using 7 kg (B300 or S300) spools, this is quite often the case with bulk wire systems. In order to overcome this problem, push-push wire feed systems have been developed within the last 5 years. With such systems, either the spool itself is driven and the wire is directly put into the wire feeder or the wire is directly pulled out from a drum. Both are done with an extremely short and straight liner. The wire feeder, which comes right after the wire container pushes the wire into the liner. A second wire feeder is situated immediately before the welding torch and controls the wire feed speed needed for the welding process. This one feeds the wire through the last few centimetres until the contact tip.

For the uncoiling of B-400 40 kg spools, special uncoiling systems are required while this is not necessary with Eco-drums and Jumbo-drums. An as-short-as-possible connection of the drum to the wire-feeder is essential (see picture). For longer connections between the bulk pack and the wire feeder we recommend our **Rolliner**.

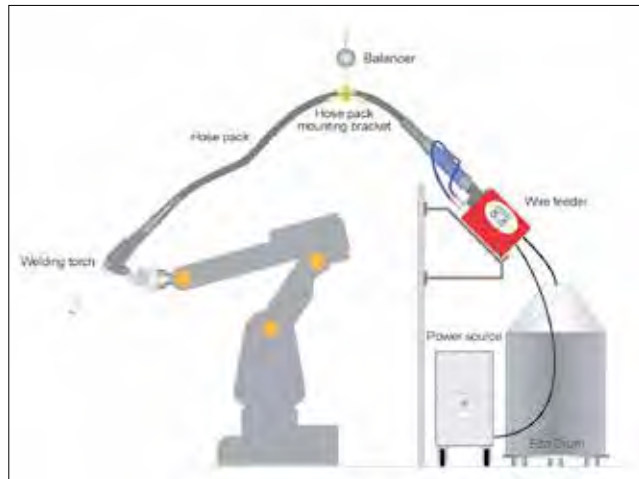

For a complete product line regarding the connection of bulk wire packs to wire-feeders refer to our separate **catalogue „Wire transport“**.

Arc ignition

Aluminium has a much higher electrical conductivity than steel. Due to this, it is much more difficult to heat the wire during short-circuit by Ohm's law ($I^2 \cdot R$) to ionise the shielding gas and to strike the arc. Additionally, the surface is covered with a hard and insulating aluminium oxide layer, which needs to be broken before short-circuit. This arc-striking problem could be partially overcome with conventional power sources with specially designed choke coils only.

Due to the advance of electronic power sources, it has become possible to increase the ignition current sufficiently fast and to reach the process parameters quickly afterwards.

For some years arc ignition is possible by means of a retractable wire feeder. With this system the wire is fed slowly to the work piece until short-circuit occurs. Then the wire is retracted a few millimetres and a low-power arc strikes. Successively the arc is quickly brought to the proper process parameters. This provides the opportunity of a spatter free ignition within a short and precise time frame. This way of arc ignition is limited to a wire feeder in immediate proximity of the contact tip in order to move the wire as accurate as possible. This may lead to a heavier and bulkier torch with disadvantages with semi-automatic and automatic applications. Only recent robotic systems can provide such a feature. There the robot and not the wire feeder do the retracting movement.

Application reference

Insufficient melting of the base metal at start and end crater at the end of the weld

Due to the high heat conductivity of aluminium, it is difficult to create enough heat to melt the base metal right after arc ignition. Afterwards, the heat flow in the work piece is faster than the welding speed and the conditions at the end of the weld are unfavourable for a proper end-crater fill. Current control programs have been integrated to the welding power sources by the manufacturers in which higher arc power is provided at start and lower power at the end of the weld. This definitely leads to an improvement, however, lack of fusion, porosity and end crater cracks are not completely prevented. Higher arc power is always linked with a higher wire quantity (wire feed speed) and lower wire quantity at the end crater with MIG welding. Exactly the opposite would be required.

If possible, the following steps should be taken:

- Use of run-in and run-out plates
- Beginning and end of weld on the base metal
- Preheating
- Well cooled welding fixtures

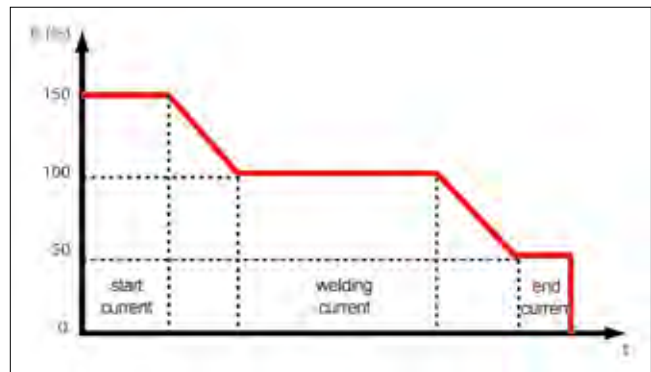

Figure: Current program with increased start current and reduced end current

Black deposit on and beside the weld

With many applications (pallets for the chemical and food industry, ladder, scaffoldings) the black deposit is rather disturbing. Simple brushing removes it but requires additional operations that can often be done only manually at areas of limited access.

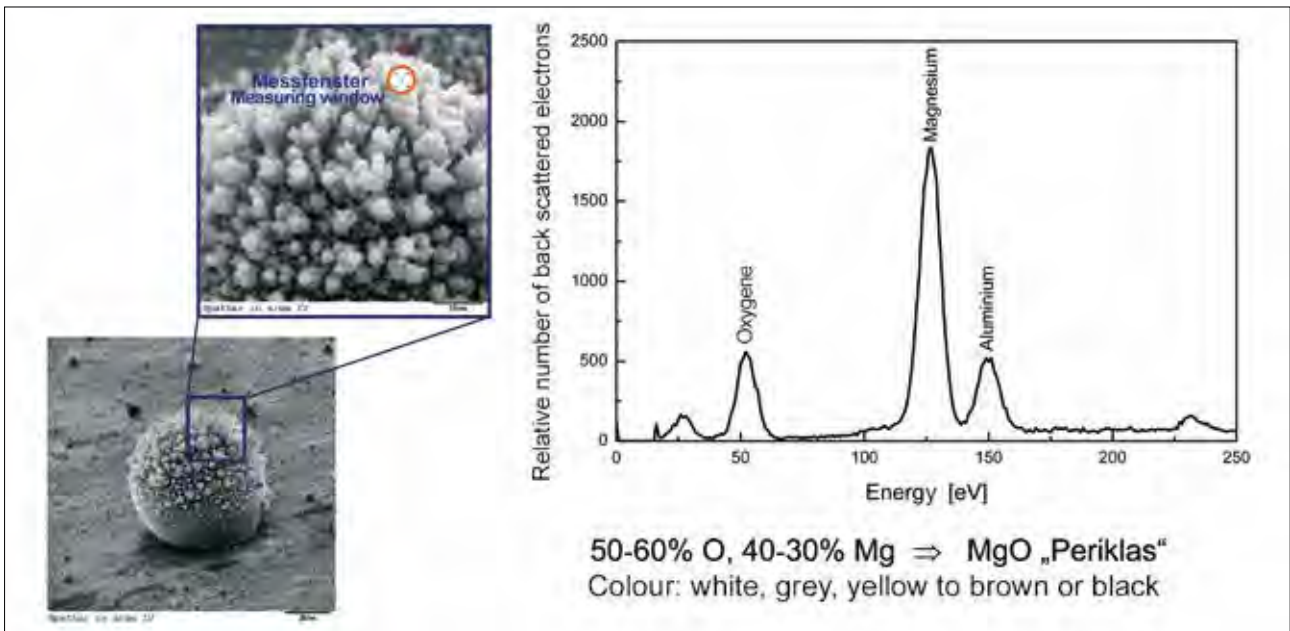

Figure: EDS analysis of black deposit

Application reference

The deposit results from evaporation and following fallout of magnesium oxide. Magnesium is an alloying element of aluminium that substantially increases its strength and cannot be left out in most cases. Magnesium oxide is usually known in white colour. An EDS-analysis eliminates any doubt of the deposit being or not MgO that is known to show grey, yellow, brown or black colours beside its white form of existence.

The following possibilities exist to prevent MgO formation:

- Use of wire electrodes with low or no Mg content (AlMg3, AISi5)
- Optimised pulse parameters for the lowest possible formation of metal vapour
- Avoid poor accessibility and resulting unfavourable torch positions
- Sufficient shielding gas protection to keep the intake of oxygen as low as possible

Special attention with gas shielded arc welding

MIG welding

Wire scratching at metallic edges

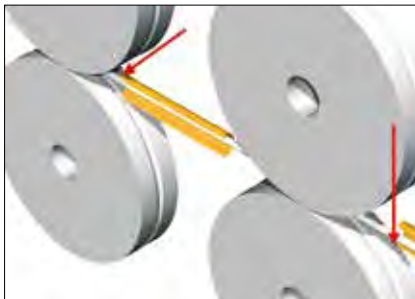

Figure: Poorly adjusted wire feed system

It must be guaranteed that the wire does not scratch over hard or metallic edges during its way from the spool to the contact tip and thereby gets damaged. Critical points are shown in the following drawings. Guiding tubes and inlet nozzles close to the feeding rolls are frequently improperly adjusted, have a too small diameter or have a bur. The same is true for contact tips, which are not suitable for soft wires in many cases. The bore diameter of contact tips for aluminium must be approximately 0.2 mm larger than for steel. Contact tips for steel have a bore diameter, which is usually 0.15-0.2 mm larger than the wire diameter, which means that tips for aluminium need to be 0.35-0.4 mm larger in diameter than the wire itself.

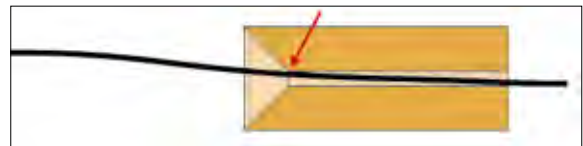

Figure: Wire rub-off at contact tip

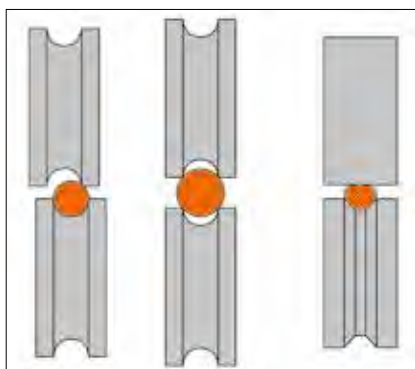

Figure: Unsuitable wire-feed-rolls

Unsuitable wire feed rolls

Rolls for aluminium and copper wires must be specially designed for aluminium by their manufacturer. A so-called semi-round groove or a similar groove shape is common.

The picture shows frequent mistakes in connection with wire feed rolls. The pressure force of the rolls to each other must be as low as possible. It should not be increased when sudden wire feed problems occur but the reason for the problems needs to be investigated and removed.

Application reference

Humidity and porous gas hoses

The reason for porosity caused by hydrogen often appears to be traceable to the state of the gas hoses. It happens that gas and water hoses get mixed up and water gets into the gas hoses. In general these hoses should be changed completely after such an incident, as a full dry-out is not possible. Another reason for humidity is porous or leaking hose materials.

$$\dot{n}_i = \frac{P_i}{\delta} \cdot (p_{i, \text{outside}} - p_{i, \text{inside}})$$

\dot{n}_i ... specific molar current of component i

P_i ... hose permeability

δ ... hose wall thickness

p_i ... partial pressure of component i

According to Fick's law, even seemingly dense materials are diffusible to matter (gases) if the partial pressure of the components is lower inside than outside. Humidity in the atmosphere diffuses through a hose wall if dry shielding gas is inside. Counter measures are a low permeability of hose material, short hoses and a greater wall thickness.

Contamination

The wire feed systems and especially all parts in touch with the wire, need to be kept as clean as possible. Usage of lubricants and anti-spatter spray must be avoided. The wire spools need to be covered at any time, thus protected from dust and humidity.

Friction in the wire feed system

Aluminium has poor gliding characteristics in general. Still, it needs to be fed through several meters of liner. Special attention must be paid to the liner material. With opened clamping levers of the wire feed rolls, it must be possible to push the wire with two fingers using medium force through the entire wire feed system. A good source of information is provided by modern power sources, which measure the electrical current into the wire feed motor. This should be close to the idle value and frequently observed.

Arc too long

Adjusting a long arc often leads to absorption of large quantities of atmosphere into the arc. This results in porosity and oxide inclusions. Thus, the welding parameters need to be optimised for an as short as possible arc. This requires much experience and sometimes demand assistance from the manufacturer of the power source.

TIG welding

During TIG welding, always make sure broken TIG cartons are closed and protected against moisture and dust. Take out only the quantity of rods necessary for the coming work. The rod can be cleaned with fine steel wool directly before welding. The rods should not be fed by a bare hand but clean gloves should be worn. To prevent excessive oxidation, leave the end of the rod in the shield gas flux of the torch until it has cooled down sufficiently. The above mentioned rules concerning moisture and leaky gas hoses are the same for TIG welding.

Preheating and inter-pass temperatures

Preheating can be done for the following reasons:

- to reduce humidity before welding, i.e. welding on site
- to remove irregularities at arc start
- to provide heat adjustment when welding different thicknesses
- to reduce the effect of cooling when welding thick plates

Application reference

The time of preheating should be as short as possible to prevent unfavourable effects. A too high preheat temperature may influence the strength of the welded joint in a negative way. By using argon-helium mixtures or pure helium as shielding gas the preheat temperature may be reduced or completely omitted.

Base metal	Maximum preheat temperature [°C]	Maximum inter-pass temperature [°C]
Not hardening alloys (1xxx, 3xxx, 5xxx, AlSi-cast, AlMg-cast)	120	120
Hardenable alloys (6xxx, AlSiMg-cast, AlSiCu-cast)	120	100
7xxx	100	80

The inter-pass temperature should be controlled for the following reasons:

- to prevent a reduction of the physical properties from overheating
- to reduce the size of the soft zone in the heat affected zone
- to reduce precipitation in the heat affected zone, i.e. by superannuation

It is recommended that the temperature at the beginning of each successive weld does not exceed the values shown in the above table.

Anodizing

Anodizing may lead to a discoloration of the weld and its heat affected zone in comparison to the base material. Silicon leads to grey or black welds and manganese to a slightly yellow colour. Due to this, only the alloys AlMg3, AlMg5 and the pure aluminium Al99.7 and Al99.5Ti are suitable for anodizing. The choice of the wire alloy should match the base material as much as possible. In case of colour critical applications, each batch of filler wire should be tested prior to welding.

Correct storage

Our filler metals have to be stored at temperatures well above the dew point any time. This can be maintained safely in a heated room at a temperature above 15° Celsius and a relative humidity below 50%. In case that this is not possible special packagings may be used.

Storage at very high temperature (> 25° Celsius) shall be avoided as well, due to the fact that the lubricant on the wire may volatilize too early. When material is taken from the storage always choose the product with the oldest manufacturing date (FIFO)!



Filler metals that are not fully consumed have to be packed prior to storage. Obviously damaged or wet packages of filler metals can be used only after approval from a qualified person (manufacturer, welding supervisor). Drying of wet welding wires or rods is not possible.

A maximum duration of storage cannot be specified in general. In doubt a qualification by welding tests must be performed.

Application reference

Common welding defects and how to avoid them

Defect	Main reasons	Prevention and counter measurements
Porosity	Contaminated filler wire. Humidity on the surface of the filler wire.	Improve the cleanliness of the filler wire and the environment. Welding above dew-point.
	Contaminated base material. Humidity on the surface of the base material.	Cleaning and drying of the welding area, ie. Preheating. Make sure that the base material is at room temperature before welding.
	Unsuitable welding positions.	Use welding positions PA, PB, PF if possible.
	Degassing time too short.	Increase heat-input and/or preheating. Modify joint preparation.
	Contaminated shielding gas, due to leaking cooling water or gas supply systems.	Remove leaks.
	Contaminated shielding gas due to diffusion of humidity. Unsuitable hose material.	Use gases complying to EN 439. Use suitable hose materials, replace old and porous hoses and keep hose length as short as possible.
	Non-laminar gas flow due to too high or too low gas flow or air draft.	Optimize shielding gas quantity. Prevent air drafts.
	Arc voltage too high.	Optimize arc voltage.
	Torch angle too small.	Use proper torch angle.
Oxide inclusions	Formation of oxides in the arc or in the weld pool by intake of Oxygen due to insufficient gas flow.	See porosity. Optimize gas flow quantity. Prevent air drafts.
	Insufficient cleaning of the welding area and/or the preceding layers.	Make sure that the welding area and preceding layers are cleaned.
	Excess of oxygen in the preheating flame.	Optimize flame.
	Unsuitable treatment of the rods with TIG-welding.	Do not retract the rod end from the shielding gas.
Cracking	Solidification characteristic of the weld pool.	Select the filler wire for optimized weldability. Make endcrater on run-out plates or use a crater fill program.
	Inner tensions.	Use welding sequences which reduce tension and distortion.
	Remelting of components with a low melting range, which precipitate at grain boundaries in the heat affected zone.	Reduce heat input and inter-pass temperature. Reduce susceptibility of cracks by using a single-pass technique. Reduce inner tensions. Select suitable filler wires (ie. 4xxx-series).
Tungsten inclusions	Tungsten inclusions from excessive current or from touching the weld pool.	Reduce current or select a larger diameter. Do not touch the weld pool with the electrode tip.
Copper inclusions	Copper inclusions with MIG-welding due to overheating.	Select a torch and a tip suitable for the amperage.
	Uptake of Copper from the backup plate.	Replace the Copper backing plate. If necessary use backup made from stainless steel, aluminium or ceramics.

Copper Alloys



ML CuAl8

Rod/Wire electrode for Copper

Typical composition in %	Al 6,00-8,50 Si < 0,20 Mn < 0,50 Zn < 0,20 Pb < 0,02 Others total < 0,40
Classification	ISO 24373 S Cu 6100 (CuAl7) DIN 1733 SG-CuAl8 Material No. 2.0921 BS 2901 part 3 C 28 AWS A 5.7 ER Cu Al-A1
Base materials	CuAl5; CuAl8; CuAl9; CuZn20Al
Remarks	Filler metal for joining and surfacing of Al-bronze, brass, steel- and cast-iron, as well as for MIG-brazing of carbonsteel with and without coating. Suitable for joining of steel to copper. The weld metal is resistant to corrosion, wear and brackish water.
Physical properties (Approx. values)	Electrical conductivity [$S \cdot m/mm^2$] 8 Density [kg/dm^3] 7,7 Solidus-Temperature [$^{\circ}C$] 1030 Liquidus-Temperature [$^{\circ}C$] 1040 Tensile strength R_m [MPa] 390 - 450 Elongation A_5 ($L_0=5d_0$) [%] 45 Hardness [HB] 140
Welding position	PA, PB, PC, PE, PF
Shielding gas	I1, I2, I3 (Argon, Helium or Argon/Helium-mixtures)
Polarity	MIG =+, TIG ~
Dimensions Ø	MIG-wires [mm] 0,8; 1,0; 1,2; 1,6; 2,0; 2,4; 3,2 TIG-rods [mm] 1,6; 2,0; 2,4; 3,2; 4,0
Wire packagings	Spools Packaging units S 200 / 5 kg n/a S 300 / 15 kg 25 spools = 375 kg (pallet) B 300 / 3 kg n/a B 300 / BS 300 / 15 kg 25 spools = 375 kg (pallet) Eco-drum / 200 kg 2 drums = 400 kg (pallet)
Rod packagings	Box 10 kg Length 1.000 mm

ML CuAl8Ni2

Rod/Wire electrode for Copper

Typical composition in %	Al 7,00-9,50 Si < 0,20 Mn 0,50-2,50 Ni (incl. Co) 0,50-3,00 Zn < 0,20 Pb < 0,02 Fe 0,50-2,50 Others total < 0,40
Classification	ISO 24373 S Cu 6327 (CuAl8Ni2Fe2Mn2) DIN 1733 SG-CuAl8Ni2 Material No. 2.0922 BS 2901 part 3 C 29
Base materials	CuAl10Ni; CuAl11Ni; Copper-aluminium-nickel alloys in general
Remarks	Filler metal for Cu-Al-Ni-materials and for joining steel to Cu-Al-alloys. Surfacing of Al-bronzes and aluminium coated steels. Can be used for cast-iron in mechanical engineering, shipbuilding and chemical industry. Excellent sea water resistance (i.e. surfacing of ship's propellers). MIG pulse welding is recommended for multi-pass surfacing welds on steel.
Physical properties (Approx. values)	Electrical conductivity [$S \cdot m/mm^2$] 5 Density [kg/dm^3] 7,5 Solidus-Temperature [$^{\circ}C$] 1030 Liquidus-Temperature [$^{\circ}C$] 1050 Tensile strength R_m [MPa] 430-540 Elongation A_5 ($L_0=5d_0$) [%] 30 Hardness [HB] 130-150
Welding position	PA, PB, PC, PE, PF
Shielding gas	I1, I2, I3 (Argon, Helium or Argon/Helium-mixtures)
Polarity	MIG =+
Dimensions Ø	MIG-wires [mm] 1,0; 1,2; 1,6
Wire packagings	Spools Packaging units B 300 / BS 300 / 15 kg 25 spools = 375 kg (pallet)

ML CuAl8Ni6

Rod/Wire electrode for Copper

Typical composition in %	Al 8,50-9,50 Si < 0,10 Mn 0,60-3,50 Ni (incl. Co) 4,00-5,50 Zn < 0,10 Pb < 0,02 Fe 3,00-5,00 Others total < 0,50
Classification	ISO 24373 S Cu 6328 (CuAl9Ni5Fe3Mn2) DIN 1733 SG-CuAl8Ni6 Material No. 2.0923 BS 2901 part 3 C 26 Ni AWS A 5.7 ER CuNiAl
Base materials	CuAl11Ni6Fe5; CuAl10Ni5Fe4; Copper-aluminium-nickel alloys in general
Remarks	Filler metal for Cu-Al-Ni-materials and for castings and forged parts from nickel-aluminium bronzes. Surfacing of Al-bronzes and aluminium coated steels, and complex bronzes. Excellent sea water resistance (i.e. surfacing of ship's propellers). High wear and abrasion resistance. Suitable for bearings, valves, turbines, pumps, etc.
Physical properties (Approx. values)	Electrical conductivity [S*m/mm ²] 4 Density [kg/dm ³] 7,5 Solidus-Temperature [°C] 1015 Liquidus-Temperature [°C] 1045 Tensile strength R _m [MPa] 450-560 Elongation A ₅ (L ₀ =5d ₀) [%] 10 Hardness [HB] 150-170
Welding position	PA, PB, PC, PE, PF
Shielding gas	I1, I2, I3 (Argon, Helium or Argon/Helium-mixtures)
Polarity	MIG =+
Dimensions Ø	MIG-wires [mm] 1,0; 1,2; 1,6
Wire packagings	Spools Packaging units B 300 / BS 300 / 15 kg 25 spools = 375 kg (pallet)

ML CuAl9Fe

Rod/Wire electrode for Copper

Typical composition in %	Al 8,50 - 11,00 Si < 0,10 Zn < 0,02 Pb < 0,02 Fe < 1,50 Others total < 0,50
Classification	ISO 24373 S Cu 6180 (CuAl10Fe1) DIN 1733 SG-Cu Al 10 Fe Material No. 2.0937 BS 2901 Part 3 C 13 AWS A 5.7 ER CuAl – A2
Base materials	CuAl8Fe3
Remarks	Filler wire for joining and surfacing of base metals with similar composition, manganese-silicon-bronzes and some copper-nickel-alloys. Suitable for joining of steel to copper. The weld metal is sea water resistant. Very well suitable for flame spraying.
Physical properties (Approx. values)	Electrical conductivity [$S \cdot m/mm^2$] 8 Density [kg/dm^3] 7,7 Solidus-Temperature [$^{\circ}C$] 1030 Liquidus-Temperature [$^{\circ}C$] 1040 Tensile strength R_m [MPa] 390 - 500 Elongation A_5 ($L_0=5d_0$) [%] 35 Hardness [HB] 140 - 160
Welding position	PA, PB, PC, PE, PF
Shielding gas	I1, I2, I3 (Argon, Helium or Argon/Helium-mixtures)
Polarity	MIG =+, TIG ~
Dimensions Ø	MIG-wires [mm] 0,8; 1,0; 1,2; 1,6; 2,0; 2,4; 3,2 TIG-rods [mm] 1,6; 2,0; 2,4; 3,2; 4,0
Wire packagings	Spools Packaging units S 300 / 15 kg 25 spools = 375 kg (pallet) B 300 / BS 300 / 15 kg 25 spools = 375 kg (pallet) Eco-drum / 200 kg 2 drums = 400 kg (pallet)
Rod packagings	Box 10 kg Length 1.000 mm

ML CuMn13Al7

Rod/Wire electrode for Copper

Typical composition in %	Al 7,00-8,50 Si < 0,10 Mn 11,00-14,00 Ni (einschl. Co) 1,50-3,00 Zn < 0,15 Pb < 0,02 Fe 2,00-4,00 Others total < 0,50
Classification	ISO 24373 S Cu 6338 (CuMn13Al8Fe3Ni2) DIN 1733 SG-CuMn13Al7 Material No. 2.1367 BS 2901 part 3 C 22 AWS A 5.7 ER CuMnNiAl
Base materials	Seawater resistant CuAl-alloys without zinc of high hardness and strength.
Remarks	ML CuMn13Al7 is a manganese-nickel-aluminium bronze for sea water resistant joint welds, particularly with erosion, corrosion and cavitation. Suitable for surfacing of Cu-alloys, carbon-manganese steels and cast-iron.
Physical properties (Approx. values)	Electrical conductivity [S*m/mm ²] 3-5 Density [kg/dm ³] 7,4 Solidus-Temperature [°C] 945 Liquidus-Temperature [°C] 985 Tensile strength R _m [MPa] 800-900 Elongation A ₅ (L ₀ =5d ₀) [%] 10 Hardness [HB] 180-240
Welding position	PA, PB, PC, PE, PF
Shielding gas	I1, I2, I3 (Argon, Helium or Argon/Helium-mixtures)
Polarity	MIG =+, TIG ~
Dimensions Ø	MIG-wires [mm] 0,8; 1,0; 1,2; 1,6 TIG-rods [mm] 1,6; 2,0; 2,4; 3,2; 4,0
Wire packagings	Spools Packaging units B 300 / BS 300 / 15 kg 25 spools = 375 kg (pallet)
Rod packagings	Box 10 kg Length 1.000 mm

ML CuNi10Fe

Rod/Wire electrode for Copper

Typical composition in %	Ni 9,00-11,00 Fe 0,50-2,00 C < 0,03 Mn 0,50-1,50 Si < 0,20 Ti 0,20-0,50 Al < 0,03 S < 0,02 P < 0,007 Pb < 0,02 Others total < 0,40
Classification	ISO 24373 S Cu 7061 (CuNi10) DIN 1733 SG-CuNi10Fe Material No. 2.0873 BS 2901 part 3 C 16
Base materials	Particularly suitable for highly stressed corrosion resistant weld surfacing on cast iron and on unalloyed and low-alloyed steel, seawater resistant CuZn alloys. Appropriate to joining/surfacing on Cu-Ni material. Especially recommended for plant engineering.
Physical properties (Approx. values)	Electrical conductivity [S*m/mm ²] 5 Therm. conductivity [W/m K] 45 Density [kg/dm ³] 8,9 Melting temperature [°C] 1.150 Tensile strength R _m [MPa] 300 Elongation A ₅ (L ₀ =5d ₀) [%] 40 Modulus of elasticity [MPa] 126.000
Welding position	PA, PB, PC, PE, PF
Shielding gas	I1, I2, I3 (Argon, Helium or Argon/Helium-mixtures)
Polarity	MIG =+, TIG =-
Dimensions Ø	MIG-wires [mm] 1,0; 1,2; 1,6 TIG-rods [mm] 1,6; 2,0; 2,4
Wire packagings	Spools Packaging units B 300 / BS 300 / 15 kg 25 spools = 375 kg (pallet)
Rod packagings	Box 5 kg Length 1.000 mm

ML CuNi30Fe

Rod/Wire electrode for Copper

Typical composition in %	Ni 29,00-32,00 Fe 0,40-1,00 C < 0,05 Mn 0,50-1,50 Si < 0,20 Ti 0,20-0,50 S < 0,015 P < 0,02 Pb < 0,02 Others total < 0,50
Classification	ISO 24373 S Cu 7158 (CuNi30Mn1FeTi) DIN 1733 SG-CuNi30Fe Material No. 2.0837 AWS A 5.7 ER CuNi BS 2901 part 3 C 18
Base materials	Particularly suitable for high stressed corrosion resistant weld surfacing on cast iron and on unalloyed and low-alloyed steel as well as seawater resistant CuNi alloys. Suitable for welding on CuNi materials. Particularly recommended for the plant engineering.
Physical properties (Approx. values)	Electrical conductivity [S*m/mm ²] 2 Therm. conductivity [W/m K] 30 Density [kg/dm ³] 8,9 Melting temperature [°C] 1.210 Tensile strength R _m [MPa] 400 Elongation A ₅ (L ₀ =5d ₀) [%] 35
Welding position	PA, PB, PC, PE, PF
Shielding gas	I1, I2, I3 (Argon, Helium or Argon/Helium-mixtures)
Polarity	MIG =+, TIG =-
Dimensions Ø	MIG-wires [mm] 1,0; 1,2; 1,6 TIG-rods [mm] 1,6; 2,0; 2,4
Wire packagings	Spools Packaging units B 300 / BS 300 / 15 kg 25 spools = 375 kg (pallet)
Rod packagings	Box 5 kg Length 1.000 mm

ML CuSi28L

Rod/Wire electrode for Copper

Typical composition in %	Al < 0,02 Si 2,80-3,00 Mn 0,75-0,95 Sn < 0,05 Zn < 0,10 Pb < 0,01 Fe < 0,10 Ni < 0,05 P < 0,05 Others total < 0,50
Classification	ISO 24373 S Cu 6560 (CuSi3Mn1) DIN 1733 SG-CuSi3 Material No. 2.1461 BS 2901 part 3 C 9 AWS A 5.7 ER CuSi-A
Base materials	CuZn5; CuZn10; CuZn15; CuSi2Mn; CuSi3Mn
Remarks	Modified CuSi3, especially for Laserbrazing and MIG-brazing in the automotive industry.
Physical properties (Approx. values)	Electrical conductivity [S*m/mm ²] 3-4 Density [kg/dm ³] 8,5 Solidus-Temperature [°C] 910 Liquidus-Temperature [°C] 1025 Tensile strength R _m [MPa] 330-370 Elongation A ₅ (L ₀ =5d ₀) [%] 40 Hardness [HB] 80-90
Welding position	PA, PB, PC, PE, PF
Shielding gas	I1, I2, I3 (Argon, Helium or Argon/Helium-mixtures)
Polarity	MIG =+, TIG =-
Dimensions Ø	MIG-wires [mm] 0,8; 1,0; 1,2; 1,6; 2,0; 2,4; 3,2 TIG-rods [mm] 1,6; 2,0; 2,4; 3,2; 4,0
Wire packagings	Spools Packaging units S 200 / 5 kg n/a S 300 / 15 kg 25 spools = 375 kg (pallet) B 300 / 3 kg n/a B 300 / BS 300 / 15 kg 25 spools = 375 kg (pallet) Eco-drum / 200 kg 2 drums = 400 kg (pallet)
Rod packagings	Box 10 kg Length 1.000 mm

ML CuSi3

Rod/Wire electrode for Copper

Typical composition in %	Al < 0,02 Si 2,80-4,00 Mn 0,50-1,50 Sn < 0,20 Zn < 0,40 Pb < 0,02 Fe < 0,50 P < 0,05 Others total < 0,50
Classification	ISO 24373 S Cu 6560 (CuSi3Mn1) DIN 1733 SG-CuSi3 Material No. 2.1461 BS 2901 Part 3 C 9 AWS A 5.7 ER CuSi – A
Base materials	CuZn5; CuZn10; CuZn15; CuSi2Mn; CuSi3Mn
Remarks	Filler wire for joining copper, copper-silicon and copper-zinc alloys. Suitable for joining of steel to copper and for surfacing of steel. High temperature and corrosion resistance. Very commonly used for galvanized steel.
Physical properties (Approx. values)	Electrical conductivity [S*m/mm ²] 3-4 Density [kg/dm ³] 8,5 Solidus-Temperature [°C] 910 Liquidus-Temperature [°C] 1025 Tensile strength R _m [MPa] 330 - 370 Elongation A ₅ (L ₀ =5d ₀) [%] 40 Hardness [HB] 80 - 90
Welding position	PA, PB, PC, PE, PF
Shielding gas	I1, I2, I3 (Argon, Helium or Argon/Helium-mixtures)
Polarity	MIG =+, TIG -
Dimensions Ø	MIG-wires [mm] 0,8; 1,0; 1,2; 1,6; 2,0; 2,4; 3,2 TIG-rods [mm] 1,6; 2,0; 2,4; 3,2; 4,0
Wire packagings	Spools Packaging units S 200 / 5 kg n/a S 300 / 15 kg 25 spools = 375 kg (pallet) B 300 / 3 kg n/a B 300 / BS 300 / 15 kg 25 spools = 375 kg (pallet) Eco-drum / 200 kg 2 drums = 400 kg (pallet)
Rod packagings	Box 10 kg Length 1.000 mm

ML CuSn

Rod/Wire electrode for Copper

Typical composition in %	Al < 0,01 Si 0,10-0,40 Mn 0,10-0,40 Ni (einschl. Co) < 0,10 Sn 0,50-1,00 Pb < 0,01 Fe < 0,03 P < 0,015 Others total < 0,20
Classification	ISO 24373 S Cu 1898A (CuSn1MnSi) DIN 1733 SG-CuSn Material No. 2.1006 BS 2901 part 3 C 7 AWS A 5.7 ER Cu
Base materials	OF-Cu; SE-Cu; SW-Cu; SF-Cu; CuZn0,5
Remarks	Filler wire for joining of high-duty copper materials. Excellent weldability. High quality welds without porosity for applications in construction and for pressure vessels.
Physical properties (Approx. values)	Electrical conductivity [$S \cdot m/mm^2$] 15-20 Density [kg/dm^3] 8,9 Solidus-Temperature [$^{\circ}C$] 1020 Liquidus-Temperature [$^{\circ}C$] 1050 Tensile strength R_m [MPa] 210-245 Hardness [HB] 60-80
Welding position	PA, PB, PC, PE, PF
Shielding gas	I1, I2, I3 (Argon, Helium or Argon/Helium-mixtures)
Polarity	MIG =+, TIG -
Dimensions Ø	MIG-wires [mm] 0,8; 1,0; 1,2; 1,6; 2,0; 2,4; 3,2 TIG-rods [mm] 1,6; 2,0; 2,4; 3,2; 4,0
Wire packagings	Spools Packaging units S 300 / 15 kg 25 spools = 375 kg (pallet) B 300 / 3 kg n/a B 300 / BS 300 / 15 kg 25 spools = 375 kg (pallet) Eco-drum / 200 kg 2 drums = 400 kg (pallet)
Rod packagings	Box 10 kg Length 1.000 mm

ML CuSn6

Rod/Wire electrode for Copper

Typical composition in %	Al < 0,01 Zn < 0,10 Sn 4,00-7,00 Pb < 0,02 Fe < 0,10 P 0,01-0,40 Others total < 0,20
Classification	ISO 24373 S Cu 5180A (CuSn6P) DIN 1733 SG-CuSn6 Material No. 2.1022 BS 2901 Part 3 C 11 AWS A 5.7 ER CuSn – A
Base materials	CuSn4; CuSn6; CuSn8
Remarks	Filler wire for joining and surfacing of bronzes. Tough and pore-free weld metal with a controlled content of phosphor.
Physical properties (Approx. values)	Electrical conductivity [S*m/mm ²] 9 Density [kg/dm ³] 8,7 Solidus-Temperature [°C] 910 Liquidus-Temperature [°C] 1040 Tensile strength R _m [MPa] 320 - 360 Elongation A ₅ (L ₀ =5d ₀) [%] 25 Hardness [HB] 80 - 90
Welding position	PA, PB, PC, PE, PF
Shielding gas	I1, I2, I3 (Argon, Helium or Argon/Helium-mixtures)
Polarity	MIG =+, TIG -
Dimensions Ø	MIG-wires [mm] 0,8; 1,0; 1,2; 1,6; 2,0; 2,4; 3,2 TIG-rods [mm] 1,6; 2,0; 2,4; 3,2; 4,0
Wire packagings	Spools Packaging units S 300 / 15 kg 25 spools = 375 kg (pallet) B 300 / BS 300 / 15 kg 25 spools = 375 kg (pallet) Eco-drum / 200 kg 2 drums = 400 kg (pallet)
Rod packagings	Box 10 kg Length 1.000 mm

Application reference

Arc brazing

General

Increasing demands for the reduction of damages lead to the use of coated steels in many industrial fields. Among the many possibilities to protect steel against corrosion zinc plays a major role due to its favourable corrosion resistance and its low price.

Protection against corrosion by a zinc coating can be done by hot-galvanizing of already finished parts or work pieces. In many cases and with complicated constructions this is not possible because of distortion. Another possibility is to use already finished – pre zinc-coated – sheets or profiles for welding. Such materials can be coated by either an electrolytic or a hot-galvanizing process. The thickness of the zinc coating lies between 1 and 20µm depending on the method of manufacturing. Large quantities of zinc coated thin sheets are used in the automotive industry, for buildings, ventilation and air-conditioning systems, household appliances, and furniture.

Not only because of its ability to form a cover layer as a barrier which needs to corrode first before the steel corrodes zinc has reached a major position as corrosion protection because of its cathodic protection ability. If the protecting zinc coating is damaged then the surrounding zinc provides the cathodic protection even of the nearby uncoated steel. This protection is effective for a distance of 1-2 mm of uncoated surfaces. Due to the cathodic protection not only the uncoated cutting edges are protected, but also micro cracks from cold-forming and the surrounding of welds where zinc has been evaporated during welding. Equally subcutaneous corrosion can be avoided initiating from cutting edges.

Arc brazing of zinc-coated steels

Zinc has a melting point of approximately 420° Celsius and evaporates at 906° Celsius. This nature is unfavourable to any welding process, because evaporation of zinc starts before the melting point of steel being the base material is reached. This is the reason why it is more suitable for galvanized steel when less heat is introduced, respectively the base material does not get to its melting point at all.

An alternative to welding of coated sheets is the use of filler wires based on copper also known as bronzes. Commonly known are wires with copper-silicon- (ML CuSi3) and copper-aluminium-alloys (ML CuAl8).

The following advantages are provided by these wires:

- no corrosion of the brazing
- minimal spatter
- low burn-off of coating
- low heat input
- simple post-treatment of the seam
- cathodical protection of the base material in the immediate area of the joint

Such bronze wires have a relatively low melting point due to the high content of copper (approx. 1.000 to 1.080° Celsius depending on the alloy). The base material does not get molten which means the joining principle is more brazing than welding. With arc brazing fluxes are usually not required.

Application reference

Classification of arc brazing processes

Arc brazing can be classified into GMA and GTA processes. The principle is largely identical to GMAW-welding respectively to plasma welding with filler wires.

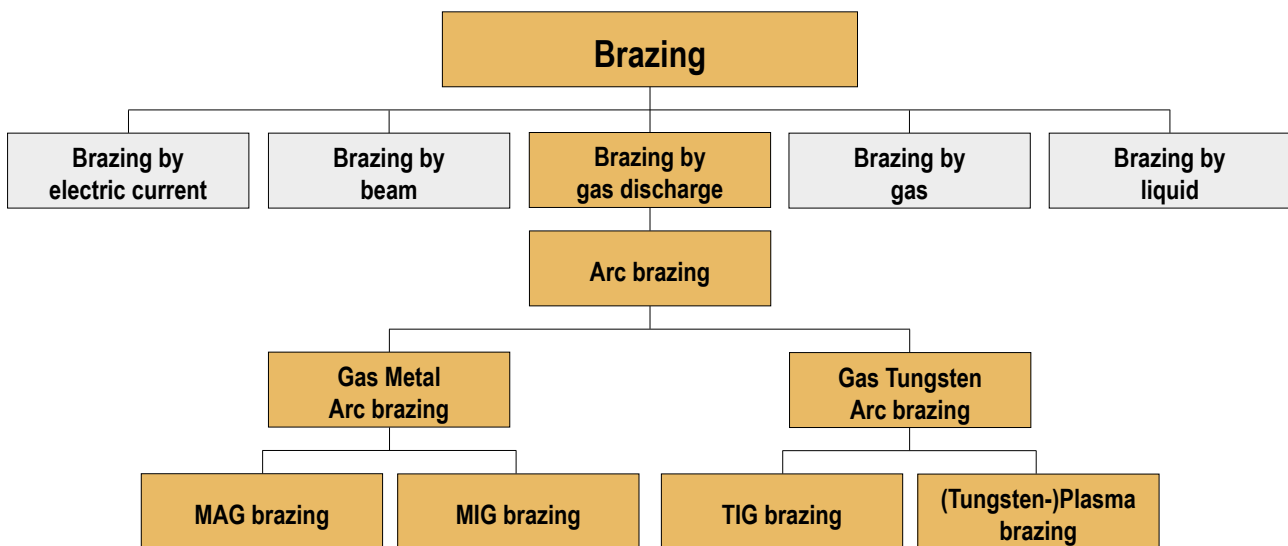

Figure: Classification of brazing processes

GMA brazing

The difference between GMA brazing to Gas Metal Arc Welding lies in the use of filler metals based on copper alloys instead of steel. This process is mainly used in the short- or pulsed arc mode in virtually all positions. A separate joint preparation is usually not necessary.

Short-arc process

The short-arc process provides GMA brazing with low heat input. At low arc power the droplet transfer occurs during the short-circuit phase (short-arc process).

Pulsed arc process

The pulsed arc technology provides a well controllable droplet transfer with few short-circuits and a good gap-bridging characteristic for brazing overlap joints. Generally the pulsed arc process gives flatter seams than the short-arc process. Because the evaporation of the coating may lead to arc instabilities it is recommended to use a short arc length. With Argon as shielding gas a low spatter process can be obtained at optimized parameters. To keep the heat input as low as possible a low base current is required.

Application reference

Special requirements to the brazing equipment

GMA brazing requires special precautions on the power source. In order to keep the evaporation of zinc as low as possible, brazing is done at low arc power. Therefore, the power source needs to have a control range which goes to low levels of arc power. At the same time arc stability must be provided. A low base current together with a fast reacting arc-control to obtain a short arc length is required.

Depending on each combination of filler metal and shielding gas GMA brazing requires a special pulse shape. Generally seen most available power sources on the market give good brazing characteristics. It might be necessary, however, to obtain an optimized arc characteristic from its manufacturer.

The filler wires used are softer than wires for steel welding, and require higher demands on the wire-feed units. Similar to aluminium- or flux-cored wires wire-drive systems need to be equipped with semi-grooved wire feed rolls. The wire feed motor should be controlled to provide constant feeding speed. Hose packs must be equipped with plastic or Teflon liners. In case that hose pack lengths of more than 3 m for semiautomatic or more than 1.5 m for automatic brazing are necessary an extra wire-feed motor at the torch is required. For automatic brazing it is useful to use water cooled torches.

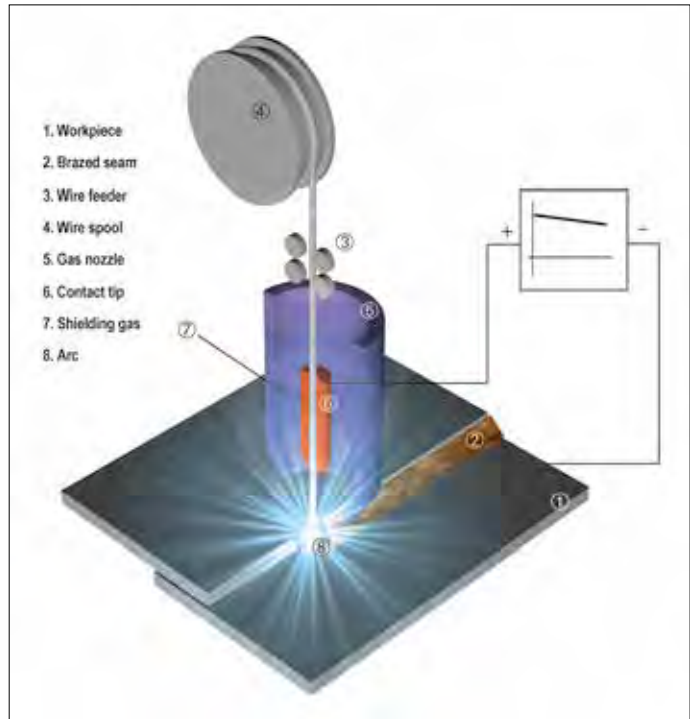

Figure: Schematics of GMA brazing

Technological remarks

An additional important influence on the seam quality for GMA brazing is the torch angle and torch guidance. With a pushing arc angle the forerunning arc preheats the zinc coating as much that it may evaporate immediately before the arc down to a small rest. The heat energy of the molten metal droplet from the filler wire evaporates the, until then, remaining coating. Because the quantity of the remaining zinc coating in the still molten brazing alloy is rather low the remaining time until solidification is long enough for degassing.

Application reference

TIG brazing

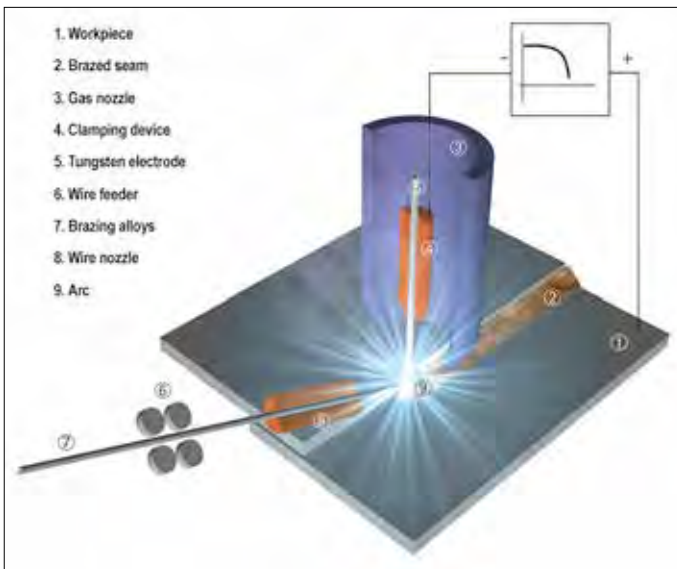

Figure: Schematics of TIG brazing

With manual TIG brazing the brazing alloy is usually fed into the arc similar to autogenous brazing with a rod. With automatic TIG brazing the copper alloys are wires like for MIG welding, or so-called cold wires. Usually a continuous arc is applied. Flat- and vertical down positions should be preferred.

Special requirements to the brazing equipment

All commonly available TIG-DC power sources can be used. Pulsed arc machines are not necessary. For most applications currents of 20-150 A are sufficient. For automatic welding a cold wire feeder is required.

Plasma brazing

With plasma brazing either pulsed or continuous arc currents can be applied. Flat- and vertical-down positions are recommended. In opposite to GMA brazing the filler wire is fed into the arc without any current into the focused arc. The deposit of the filler wire is therefore (nearly) independent from the heat input. This makes the seam geometry variable within large boundaries.

Plasma brazing with current on the wire is called **plasma hotwire brazing**. This variant differs basically only in the additional power provided by another current through the wire. The increased temperature of the filler wire can be used to increase the brazing speed and reduces distortion.

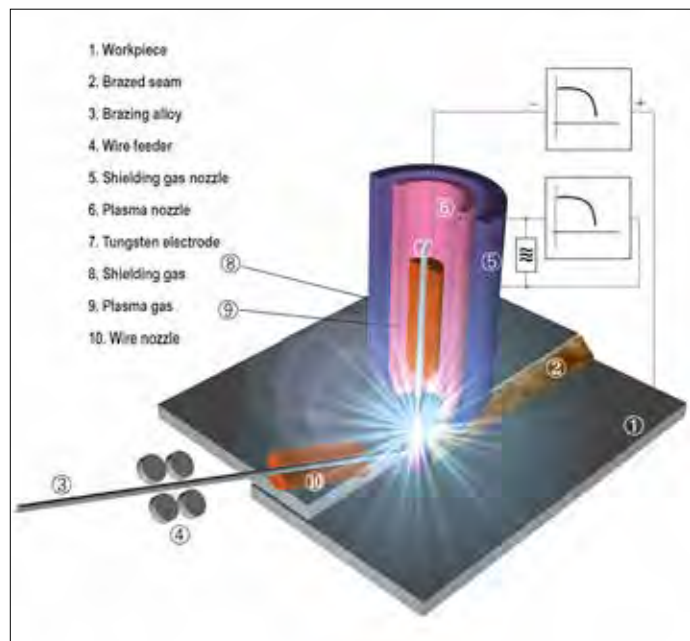

Figure: Schematics of plasma brazing

Application reference

Special requirements to the brazing equipment

For both, standard and pulse mode, power sources with a dropping characteristic are required. The power source is equipped with an ignition device (high-frequency) for a touchless striking of the arc. The high-frequency unit usually strikes the arc between the electrode and the plasma nozzle or between the electrode and the work piece.

Manual applications usually work in a current range from 5-75 A. Mechanized or robotic applications may need up to 250 A. Plasma torches are usually water cooled to carry off the process heat and to provide production adequate service life. The wire is fed from external without a current. Due to the separation of wire feed and arc power it is for instance possible to do repair jobs by remelting without wire.

Materials for arc brazing

Base materials

The arc brazing processes are generally used for joining of uncoated or coated steel fine sheets in a thickness range of up to 3.0 mm. With higher tensile strength of the steel sheets it must be considered that the strength of the brazing alloy is usually lower than the strength of the base metal.

A speciality is brazing of different base materials i.e. of copper alloys with steel. These joints show two different characteristics, brazing on the steel side and welding on the copper side.

Even stainless steel can be joined with arc brazing. In particular the low heat input can be of great advantage with long seams and thin materials, because distortion of the work pieces is greatly reduced. Due to a higher susceptibility for soldering cracks it needs to be tested in every single case. The improved gap-bridging capability is responsible for a higher tolerance on work piece dimensions. ML CuAl8 is the recommended filler wire. The colour difference between base material and filler wire must be obeyed.

Surface coatings and preparation

Sheets with a coating thickness of up to 15 µm can generally be used without any problems. In case that i.e. hot-galvanized work pieces with greater thicknesses are used additional investigations may be required. For base metals covered with aluminium also aluminium containing brazing alloys shall be used. Additional organic coatings may need specially adapted parameters.

In order to obtain a metallurgical interaction between the base material and the wetting liquid braze the border area should be clean and pure metal. Dirt, grease, residuals from machining, wax, adhesives or oil may reduce the joint quality (porosity, lack of fusion etc.) and shall be removed by either chemical and/or mechanical surface treatment processes.

Consumables and auxiliary materials

Brazing consumables

For arc brazing mainly the two alloys ML CuSi3 and ML CuAl8 are used as wires or rods. With MIG brazing a wire diameter of 1.0 mm is commonly used. Traditionally for Germany the ML CuSi3 is applied, whilst in other countries the alloy ML CuAl8 is used for similar applications. ML CuAl8 is also used for brazing of stainless steel and for joints in the furniture industry where the optical look of the seam surface is essential.

Application reference

MIG WELD consumables are optimized for GMA brazing. The wires have an ideal hardness and provide the best gliding characteristic.

Shielding gases

For arc brazing usually argon or Ar-mixes with additions of CO_2 or O_2 are used. Together with filler metals containing Si or Sn low active additions of CO_2 or O_2 may be of advantage. These gases stabilize the arc, reduce porosity, however, increase the heat input into the workpiece. N_2 additions stabilize the arc and give a wider seam, however, may produce considerable amounts of porosity. H_2 additions increase the speed of brazing, but may also lead to porosity.

In order to optimize the shielding gas composition to the brazing job it is recommended to use the experiences from gas manufacturers.

Joint designs

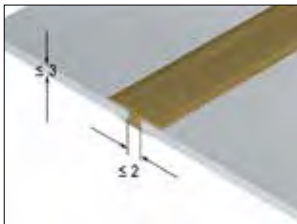

Butt design

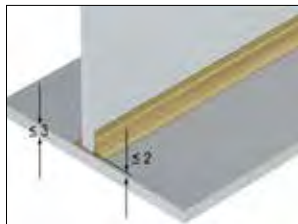

Fillet design

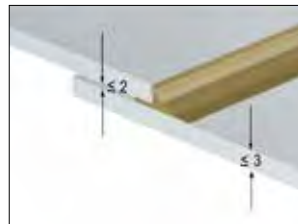

Overlap design

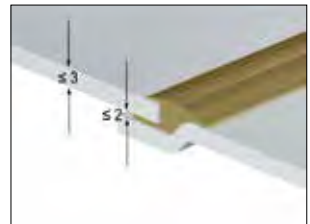

Overlap design on shouldered sheet

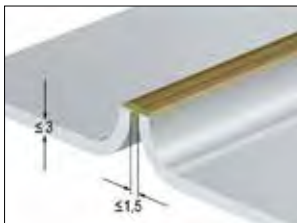

Lateral face design

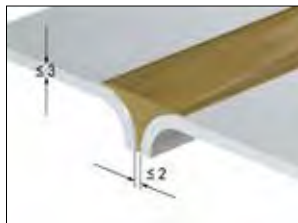

Flanged-butt design



Corner design

Occupational health

Suitable fume extraction devices are required for semiautomatic brazing jobs and if necessary torches with integrated fume collection should be used. In case that seams need to be ground off the maximal permitted values for fine dust must be obeyed. Suitable dust extraction devices have to be installed in such areas.

Due to occupational health and economic production a formation of zink oxide flakes (white deposit on the work piece or floating particles) must be avoided by reduction of the heat input.

Application reference

Laser beam brazing

At high scale production in the automotive industry laser beam brazing is used in addition to MIG brazing.

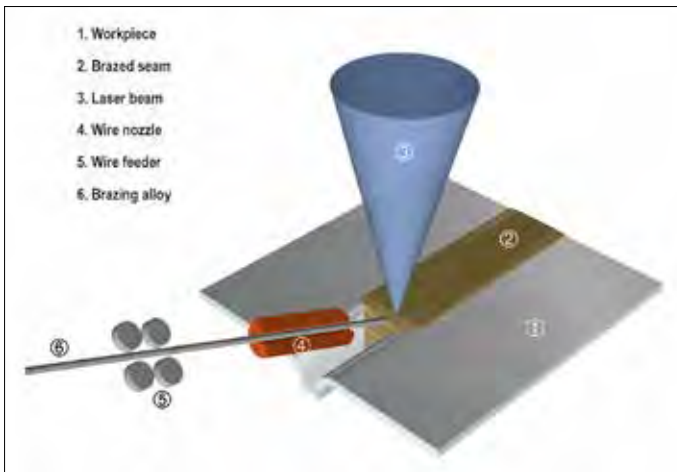

The laser being the source of heat melts the filler wire and similar to the arc a brazing result is obtained.

Suitable joint designs are also flanged-butt and fillets. The process provides very high travel speeds of up to several meters/minute at a very low heat input. Distortion is rather low. In the automotive industry so-called "Grade A" joints can be made which do not need any finish after brazing and are used in visible areas of the car body.

For a further increase of the process speed it can be extended to laser hotwire brazing by an additional current on the filler wire.

Figure: Schematics of laser brazing

Stainless Steel

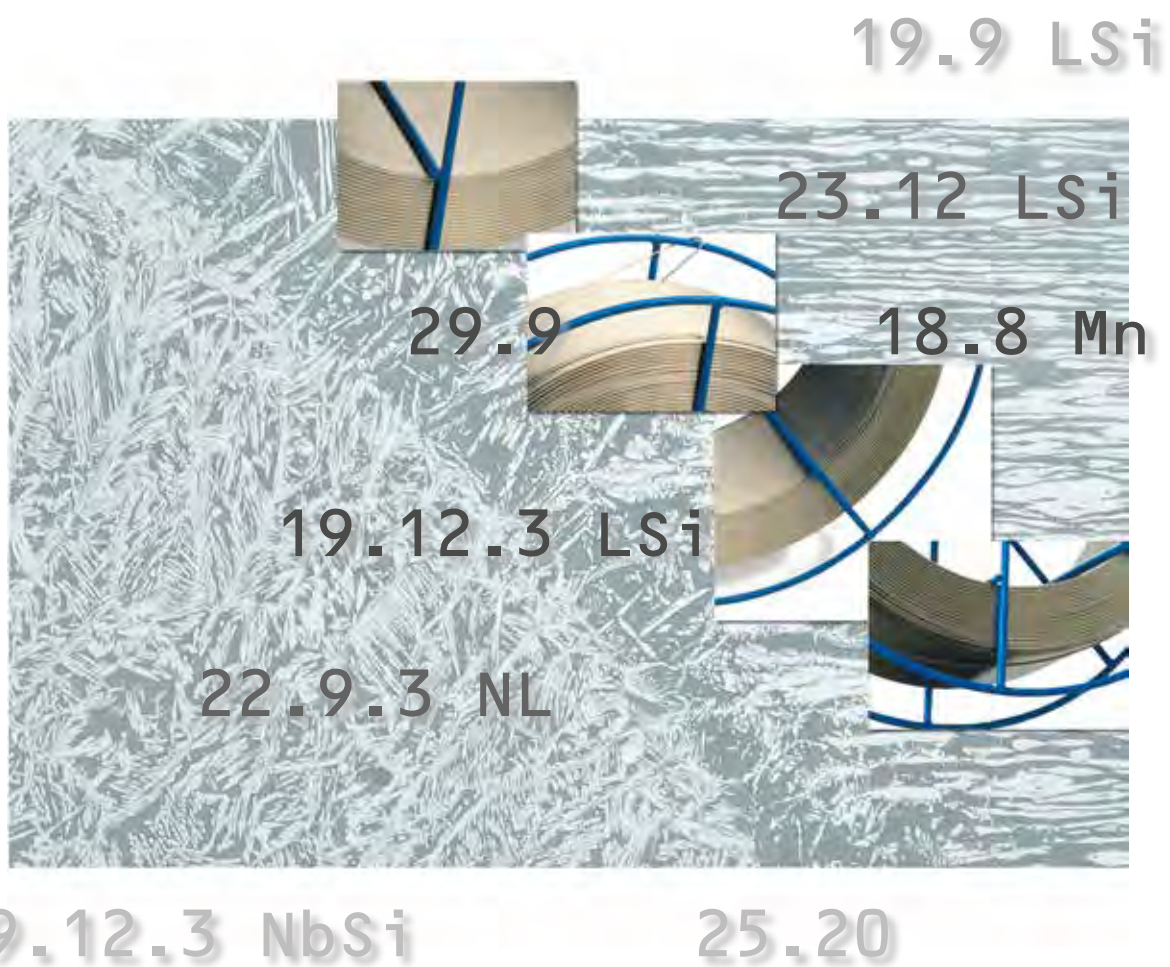

Stainless Steel

Stainless welding consumables by MIGAL.CO - better than the standard

MIGAL.CO also supplies highest quality stainless filler metals.

The high quality can be seen at first glance. The consistent silvery shine shows the smooth surface and the high constancy of manufacturing.

Experienced technicians in our R&D department continuously develop the products and processes, in order to ensure that our customers can achieve best welding results and highest productivity.

Use our Know-how

Our experience and the practical know-how are at your disposal, in order to solve your welding tasks and to increase your productivity.

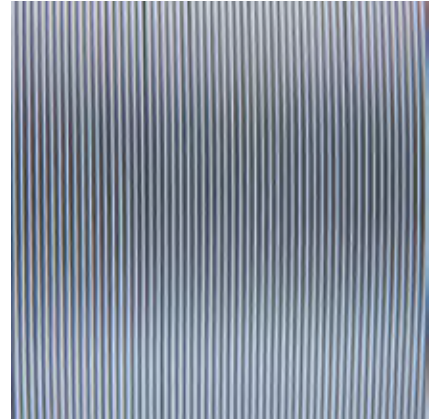

Selection of filler metal

The choice of welding consumables is crucial to the result of the welding operation. It must give the required weld properties and ensure a crack-free weld. The key factor in the choice is, of course, the parent metal, but the welding method can also influence the selection of filler metal. For surfacing, the welding parameters have to be considered as well.

Balanced composition

The composition of the welding consumable normally corresponds to that of the parent metal. For example, parent metal 304L (18 % Cr, 8 % Ni) is welded with a 308L filler metal (19 % Cr, 9 % Ni). In general, the contents of the main alloying elements - Cr, Ni and Mo - are higher in the welding consumable than in the parent metal in order to compensate for segregation in the weld metal.

Impurity levels, however, are lower in the consumable than in the parent metal in order to reduce the risk of hot cracking, and to obtain the best arc stability, fluidity and wetting properties. In standard austenitic welding consumables - 308L, 316L, 347 - hot cracking can in practice be eliminated by a chemical composition, which gives a ferritic solidification. A ferrite content in the consumable of about 10 % (10FN) is usually sufficient, unless dilution from the parent metal is excessive.



Stainless Steel

Variants of one consumable

For most standard grades there are two versions available; one with normal and one with high silicon content. The chemical compositions have been adapted to suit the welding method.

The high silicon versions are recommended for MIG welding, because they give the best arc stability and smooth welds. In TIG and plasma-arc welding, the high silicon filler metals are not as advantageous as in MIG welding. Nonetheless, they are still preferred by many users. Thus we decided to have the LSi variants on stock.

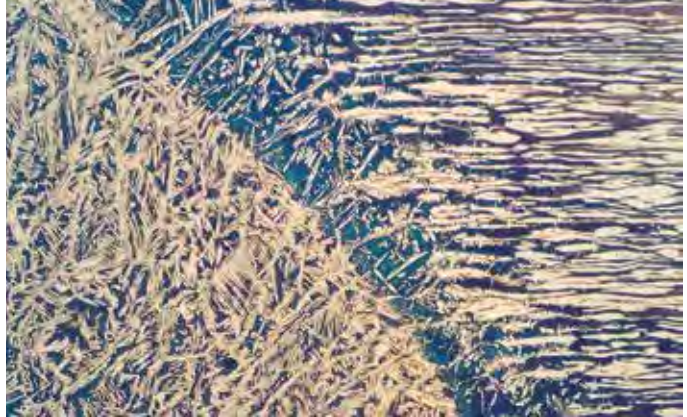

Simplified stock holding

For stock holding reasons, many fabricators use one consumable grade to weld several different parent metals. Molybdenum has been shown to give only positive effects, except in highly concentrated, hot nitric acid environments.

Therefore, 316L consumables can normally be used for both 316/316L and 304/304L parent metals. The simpler stock holding and the elimination of the risk of mixed material fully compensates for the potentially higher price for 316L consumables compared to 308L.

Delivery forms

Eco-Drum

Wire diameter 0,8; 1,0; 1,2; 1,6 mm
Outside diameter of drum 500 mm
Height without decoiling hood 820 mm
Height with decoiling hood 1080 mm
Net weight 250 kg

Basket spool BS 300

Wire diameter 0,8; 1,0; 1,2; 1,6 mm
Net weight 15 kg, precision layer wound
Highly environmentally compatible: empty rims can be treated as metal scrap.

Rods

Diameter 1,0; 1,2; 1,6; 2,0; 2,4; 3,2; 4,0 mm
Length 1000 mm
Net weight 5 kg, paper carton box
Each rod marked for identification.

1.4316 ML 19.9 LSi

Stainless steel welding wires/rods

Typical composition in %	C..... ≤ 0,025 Si..... 0,90 Mn..... 1,80 P..... ≤ 0,025 S..... ≤ 0,015 Cr..... 20 Ni..... 10,5 Mo..... ≤ 0,5 Co..... ≤ 0,2 Cu..... ≤ 0,2 N..... 0,06
Classification	DIN EN ISO 14343-A/G 19 9 L Si Materialnumber 1.4316 AWS ER 308LSi
Base materials	Joining of stainless Cr-Ni steels, stabilised or non-stabilised, e.g. 304, 304L, 321 and 247, for service temperatures up to 350° C. Also for stainless Cr steels with max. 19 % Cr. Cryogenic applications down to -269° C, depending on welding process.
Resistance against corrosion	Good resistance to general and, owing to the low C content, intergranular corrosion.
Physical properties at 20° C (Approx. values)	Yield strength $R_{p0,2}$ [MPa] 390 (20°C); 290 (400°C) Tensile strength R_m [MPa] 600 (20°C); 440 (400°C) Elongation A [%] 42 (20°C); 24 (400°C) Reduction of area [%]..... 60 Notched impact strength V [J] 120 (20°C); 50 (-196°C) Hardness [Vickers] 160 Ferrite number from standard analysis DeLong 11 Heat conductivity at temperature ° Celsius 20 100 300 500 Heat conductivity [W/m °C]..... 15 16 19 21 Thermal expansion per °C, from 20°C - 400°C 18×10^{-6} Density [g/cm ³] 7,9
Shielding gas	MIG: Ar+1-3% O ₂ , Ar+1-3% CO ₂ , Ar+He+O ₂ , Ar+He+CO ₂ , Ar+He+CO ₂ +H ₂ TIG: Ar, He, Ar+He, Ar+2-5% H ₂
Polarity	MIG =+, TIG =-
Approvals	TÜV, DB
Dimensions Ø	MIG-wires [mm] 0,8; 1,0; 1,2; 1,6 TIG-rods [mm] 1,0; 1,2; 1,6; 2,0; 2,4; 3,2; 4,0
Wire packagings	Spool types: BS 300 / 15 kg; Drum / 250 kg
Rod packagings	Box 5 kg / Length 1.000 mm

1.4332 ML 23.12 LSi

Stainless steel welding wires/rods

Typical composition in %	C ≤ 0,025 Si 0,90 Mn 1,80 P ≤ 0,025 S ≤ 0,015 Cr 23,5 Ni 13,5 Mo ≤ 0,4 N 0,10
Classification	DIN EN ISO 14343-A/G 23 12 L Si Materialnumber 1.4332 AWS ER 309LSi
Base materials	Joining of stainless Cr-Ni steels of the 309 type, wrought or cast. Also for stainless Cr steels, e.g. in the automotive industry.
Resistance against corrosion	The corrosion resistance is similar to that of the respective parent metal.
Physical properties at 20° C (Approx. values)	Yield strength $R_{p0,2}$ [MPa] 400 Tensile strength R_m [MPa] 600 Elongation A [%] 35 Reduction of area [%] 55 Notched impact strength V [J] 140 Hardness [Vickers] 200 Ferrite number from standard analysis DeLong 10 Heat conductivity at temperature ° Celsius 20 100 300 500 Heat conductivity [W/m °C] 14 15 17 19 Thermal expansion per °C, from 20°C - 400°C 18×10^{-6} Density [g/cm ³] 7,9
Shielding gas	MIG: Ar+1-3% O ₂ , Ar+1-3% CO ₂ , Ar+He+O ₂ , Ar+He+CO ₂ , Ar+He+CO ₂ +H ₂ TIG: Ar, He, Ar+He, Ar+2-5% H ₂
Polarity	MIG =+, TIG =-
Approvals	TÜV
Dimensions Ø	MIG-wires [mm] 0,8; 1,0; 1,2; 1,6 TIG-rods [mm] 1,0; 1,2; 1,6; 2,0; 2,4; 3,2; 4,0; 5,0
Wire packagings	Spool types: BS 300 / 15 kg; Drum / 250 kg
Rod packagings	Box 5 kg / Length 1.000 mm

1.4337 ML 29.9

Stainless steel welding wires/rods

Typical composition in %	C..... ≤ 0,10 Si..... 0,40 Mn..... 1,80 P..... ≤ 0,025 S..... ≤ 0,015 Cr..... 30,5 Ni..... 9,2 Mo..... ≤ 0,3 Cu..... ≤ 0,3
Classification	DIN EN ISO 14343-A/G..... 29.9 Materialnumber 1.4337 AWS ER 312
Base materials	Suitable for joining or cladding identical or similar steels or steel castings. Tough joints of un- and low-alloyed structural steels with higher strength, as well as Manganese steels and CrNiMn steels, between different materials, i. e. between stainless or heatresistant and un-/low-alloyed steels and steel castings.
Resistance against corrosion	Good resitsnace against wet corrosion up to 300° Celsius. Additionally high resistance against hotcracking and good toughness at high yield strength.
Physical properties at 20° C (Approx. values)	Yield strength $R_{p0,2}$ [MPa] 500 Tensile strength R_m [MPa] 750 Elongation A [%] 20 Notched impact strength V [J] 25
Shielding gas	MIG: Ar+1-3% O ₂ , Ar+1-3% CO ₂ , Ar+He+O ₂ , Ar+He+CO ₂ , Ar+He+CO ₂ +H ₂ WIG: Ar, He, Ar+He, Ar+2-5% H ₂
Polarity	MIG =+, WIG =-
Approvals	none
Dimensions Ø	MIG-wires [mm] 0,8; 1,0; 1,2; 1,6 TIG-rods [mm] 1,0; 1,2; 1,6; 2,0; 2,4; 3,2; 4,0
Wire packagings	Spool types: BS 300 / 15 kg; Drum / 250 kg
Rod packagings	Box 5 kg / Length 1.000 mm

1.4370 ML 18.8 Mn

Stainless steel welding wires/rods

Typical composition in %	C..... 0,08 Si..... 0,90 Mn..... 7,0 P..... ≤ 0,025 S..... ≤ 0,015 Cr..... 18 Ni..... 8 Mo..... ≤ 0,5 Co..... ≤ 0,5 Cu..... ≤ 0,1 N..... 0,06
Classification	DIN EN ISO 14343-A/G..... 18 8 Mn Materialnumber 1.4370 AWS ER 307
Base materials	Joining of work-hardenable steels, armour plates, stainless austenitic Mn steels and free-machining steels, e.g. in the automotive industry. Overlay welding of carbon and low alloyed steels.
Resistance against corrosion	The corrosion resistance is similar to that of the respective parent metal.
Physical properties at 20° C (Approx. values)	Yield strength $R_{p0,2}$ [MPa] 460 Tensile strength R_m [MPa] 650 Elongation A [%] 41 Reduction of area [%]..... 61 Notched impact strength V [J] 140 Hardness [Vickers] 200 Heat conductivity at temperature ° Celsius 20 100 300 500 Heat conductivity [W/m °C]..... 15 16 18 20 Thermal expansion per °C, from 20°C - 400°C 18×10^{-6} Density [g/cm ³] 7,8
Shielding gas	MIG: Ar+1-3% O ₂ , Ar+1-3% CO ₂ , Ar+He+O ₂ , Ar+He+CO ₂ , Ar+He+CO ₂ +H ₂ TIG: Ar, He, Ar+He, Ar+2-5% H ₂
Polarity	MIG =+, TIG =-
Approvals	TÜV
Dimensions Ø	MIG-wires [mm] 0,8; 1,0; 1,2; 1,6 TIG-rods [mm] 1,0; 1,2; 1,6; 2,0; 2,4; 3,2; 4,0
Wire packagings	Spool types: BS 300 / 15 kg; Drum / 250 kg
Rod packagings	Box 5 kg / Length 1.000 mm

1.4430 ML 19.12.3 LSi

Stainless steel welding wires/rods

Typical composition in %	C..... ≤ 0,025 Si..... 0,90 Mn..... 1,8 P..... ≤ 0,025 S..... ≤ 0,015 Cr..... 18,5 Ni..... 12 Mo..... 2,6 Co..... ≤ 0,2 Cu..... ≤ 0,2 N..... 0,06
Classification	DIN EN ISO 14343-A/G..... 19 12 3 LSi Materialnumber 1.4430 AWS ER 316LSi
Base materials	Joining of stainless Cr-Ni-Mo and Cr-Ni steels, stabilised or non-stabilised, e. g. 316, 316L and 316Ti as well as 304, 304L, 321 and 347, for service temperatures up to 400° C. Also for stainless Cr steels with max 19 % Cr.
Resistance against corrosion	Good resistance to general and, owing to low C content, intergranular corrosion. The Mo content gives good resistance also to pitting.
Physical properties at 20° C (Approx. values)	Yield strength $R_{p0,2}$ [MPa] 400 (20°C); 290 (400°C) Tensile strength R_m [MPa] 610 (20°C); 440 (400°C) Elongation A [%] 37 (20°C); 29 (400°C) Reduction of area [%]..... 68 Notched impact strength V [J] 130 (20°C); 50 (-196°C) Hardness [Vickers] 160 Heat conductivity at temperature ° Celsius 20 100 300 500 Heat conductivity [W/m °C]..... 15 16 19 21 Thermal expansion per °C, from 20°C - 400°C 18×10^{-6} Density [g/cm ³] 7,9
Shielding gas	MIG: Ar+1-3% O ₂ , Ar+1-3% CO ₂ , Ar+He+O ₂ , Ar+He+CO ₂ , Ar+He+CO ₂ +H ₂ TIG: Ar, He, Ar+He, Ar+2-5% H ₂
Polarity	MIG =+, TIG =-
Approvals	TÜV, DB
Dimensions Ø	MIG-wires [mm] 0,8; 1,0; 1,2; 1,6 TIG-rods [mm] 1,0; 1,2; 1,6; 2,0; 2,4; 3,2; 4,0
Wire packagings	Spool types: BS 300 / 15 kg; Drum / 250 kg
Rod packagings	Box 5 kg / Length 1.000 mm

1.4462 ML 22.9.3 NL

Stainless steel welding wires/rods

Typical composition in %	C ≤ 0,020 Si 0,50 Mn 1,6 P ≤ 0,020 S ≤ 0,015 Cr 23 Ni 9 Mo 3,2 N 0,16
Classification	DIN EN ISO 14343-A/G 22 9 3 N L Materialnumber 1.4462 AWS ER 2209
Base materials	Joining of duplex stainless steels i. e. 1.4417, 1.4462 und 1.4362
Resistance against corrosion	Very good resistance to intergranular corrosion and pitting. Good resistance to stress corrosion cracking, especially in environments containing H ₂ S and chlorides.
Physical properties at 20° C (Approx. values)	Yield strength R _{p0,2} [MPa] 600 (20°C); 420 (300°C) Tensile strength R _m [MPa] 750 (20°C); 600 (300°C) Elongation A [%] 25 (20°C); 20 (300°C) Notched impact strength V [J] 130 (20°C); 50 (-196°C) Hardness [Vickers] 240 Heat conductivity [W/m °C] 16 Thermal expansion per °C, from 20°C - 400°C 14,5 x 10 ⁻⁶ Density [g/cm ³] 7,9
Shielding gas	MIG: Ar+1-3% O ₂ , Ar+1-3% CO ₂ , Ar+He+O ₂ , Ar+He+CO ₂ , Ar+He+CO ₂ +H ₂ TIG: Ar, He, Ar+He, Ar+2-5% H ₂
Polarity	MIG =+, TIG =-
Approvals	TÜV
Dimensions Ø	MIG-wires [mm] 0,8; 1,0; 1,2; 1,6 TIG-rods [mm] 1,0; 1,2; 1,6; 2,0; 2,4; 3,2; 4,0
Wire packagings	Spool types: BS 300 / 15 kg; Drum / 250 kg
Rod packagings	Box 5 kg / Length 1.000 mm

1.4576 ML 19.12.3 NbSi

Stainless steel welding wires/rods

Typical composition in %	C 0,04 Si 0,90 Mn 1,2 P ≤ 0,025 S ≤ 0,015 Cr 18,5 Ni 12,5 Mo 2,6 Nb ≥ 12xC ≤ 0,6 Co ≤ 0,2 Cu ≤ 0,2 N 0,065
Classification	DIN EN ISO 14343-A/G 19 12 3 NbSi Materialnumber 1.4576 AWS ER 318Si
Base materials	Joining of stainless Cr-Ni-Mo and Cr-Ni steels, stabilised or non-stabilised, e. g. 316, 316L and 316Ti as well as 304, 304L, 321 and 347, for service temperatures up to 400° C.
Resistance against corrosion	Good resistance to general and, owing to Nb content, low intergranular corrosion. The Mo content gives good resistance also to pitting.
Physical properties at 20° C (Approx. values)	Yield strength $R_{p0,2}$ [MPa] 400 (20°C); 390 (400°C) Tensile strength R_m [MPa] 610 (20°C); 540 (400°C) Elongation A [%] 35 (20°C); 30 (400°C) Reduction of area [%] 60 Notched impact strength V [J] 110 (20°C); 40 (-196°C) Hardness [Vickers] 160 Heat conductivity at temperature ° Celsius 20 100 300 500 Heat conductivity [W/m °C] 15 16 21 23 Thermal expansion per °C, from 20°C - 400°C 18×10^{-6} Density [g/cm ³] 8,0
Shielding gas	MIG: Ar+1-3% O ₂ , Ar+1-3% CO ₂ , Ar+He+O ₂ , Ar+He+CO ₂ , Ar+He+CO ₂ +H ₂ TIG: Ar, He, Ar+He, Ar+2-5% H ₂
Polarity	MIG =+, TIG =-
Approvals	TÜV
Dimensions Ø	MIG-wires [mm] 0,8; 1,0; 1,2; 1,6 TIG-rods [mm] 1,0; 1,2; 1,6; 2,0; 2,4; 3,2; 4,0
Wire packagings	Spool types: BS 300 / 15 kg; Drum / 250 kg
Rod packagings	Box 5 kg / Length 1.000 mm

1.4842 ML 25.20

Stainless steel welding wires/rods

Typical composition in %	C..... 0,12 Si..... 0,40 Mn..... 1,80 P..... ≤ 0,025 S..... ≤ 0,015 Cr..... 26,0 Ni..... 20,7 Mo..... ≤ 0,5 Cu..... ≤ 0,4
Classification	DIN EN ISO 14343-A/G..... 25.20 Materialnumber 1.4842 AWS ER 310
Base materials	Claddings and joints on identical/similar heatresistant steels/steel castings.
Resistance against corrosion	Scale resisting up to 1.150° Celsius.
Physical properties at 20° C (Approx. values)	Yield strength $R_{p0,2}$ [MPa] 320 Tensile strength R_m [MPa] 550 Elongation A [%] 25 Notched impact strength V [J] 80
Shielding gas	MIG: Ar+1-3% O ₂ , Ar+1-3% CO ₂ , Ar+He+O ₂ , Ar+He+CO ₂ , Ar+He+CO ₂ +H ₂ WIG: Ar, He, Ar+He, Ar+2-5% H ₂
Polarity	MIG =+, WIG =-
Approvals	none
Dimensions Ø	MIG-wires [mm] 0,8; 1,0; 1,2; 1,6 TIG-rods [mm] 1,0; 1,2; 1,6; 2,0; 2,4; 3,2; 4,0
Wire packagings	Spool types: BS 300 / 15 kg; Drum / 250 kg
Rod packagings	Box 5 kg / Length 1.000 mm

Application reference

Recommendation of shielding gases for stainless steel welding

Protecting the weld



The primary tasks of a shielding gas are to protect the molten pool from the influence of the atmosphere, i. e. from oxidation and nitrogen absorption, and to stabilise the electric arc. The choice of gas can also influence the characteristics of the arc.

MIG welding

Besides the development of welding machines, the use of shielding gases contributes to increased efficiency in the MIG method. This has led to greater usage of MIG welding.

The basic gas for MIG welding is inert - argon (Ar) or helium (He), or a mixture of both. However, small additions of oxygen (O₂) or carbon dioxide (CO₂) can further stabilise the arc, improve the fluidity and also improve the quality of the weld deposit. For stainless steels there are also gases available containing small amounts of hydrogen (H₂).

TIG and plasma welding

The normal gas for TIG welding is argon or helium, or a mixture. In some cases nitrogen (N₂) and/or hydrogen (H₂) is added in order to achieve special properties. For instance, an addition of hydrogen can be used for many conventional stainless steels to increase productivity. Alternatively, if nitrogen is added, the weld deposit properties can be improved. Oxidising additions are not used because they destroy the tungsten electrode.



Gas	Parent metal					
	Austenitic	Duplex	Ferritic	High-alloy austenitic	Super duplex	Nickel alloys
MIG welding						
Ar	○	○	○	●	● a)	●
He	○	○	○	●	● a)	●
Ar + He	○	○	○	●	● a)	●
Ar + (1-3) % O ₂	● b)	● b)	● b)	● c)	● b)	
Ar + (1-3) % CO ₂ d)	● e)	● e)	● e)	● c)	● e)	
Ar + 30 % He + (1-3) % O ₂	● f)	● f)	● f)	● c)	● f)	
Ar + 30 % He + (1-3) % CO ₂ d)	● f)	● f)	● f)	● c)	● f)	
Ar + 30 % He + (1-2) % N ₂				● g)	●	

Application reference

Gas	Parent metal					
	Austenitic	Duplex	Ferritic	High-alloy austenitic	Super duplex	Nickel alloys
TIG welding						
Ar	●	●	●	●	●	
He	●	●	●	●	●	●
Ar + He	●	●	●	●	●	● h)
Ar + (2-5) % H ₂	● i)			● i)		● i)
Ar + (1-2) % N ₂		●			●	
Ar + 30 % He + (1-2) % N ₂		●			●	

● suitable ○ suitable under certain conditions

- a) Ar preferably in pulsed MIG welding.
- b) Higher fluidity of the molten pool than with Ar.
- c) Except for 22.12.HT and 27.31.4LCu where Ar is preferred.
- d) Not to be used in spray-arc welding where extra low carbon is required.
- e) Higher fluidity of the molten pool than with Ar. Better short-arc welding properties than with Ar + (1-3)% CO₂.
- f) Higher fluidity of the molten pool than with Ar. Better short-arc welding properties than with Ar + (1-3)% CO₂.
- g) For nitrogen alloyed grades.
- h) Ar + 30 % He improves flow compared with Ar.
- i) Preferably for automatic welding. High welding speed. Risk of porosity in multi-run welds.

Root protection



The perfect welding result, without impairment of corrosion resistance and mechanical properties, can only be obtained when using a backing gas with very low oxygen content. For best results, a maximum 20 ppm O₂ at the root side can be tolerated. This can be achieved with a purging set-up and can be controlled with a modern oxygen meter.

Pure argon is by far the most common gas for root protection of stainless steels. Formiergas (90 % N₂ + 10 % H₂) is an excellent alternative for conventional austenitic steels. The gas contains an active component, H₂, which brings down the oxygen level in the weld area. Nitrogen can be used for duplex steels in order to avoid nitrogen loss in the weld metal.

Tips for tack welding

Tack welds should not be thinner than specified for the root weld and should be subject to the same quality requirements for welding as are also applicable for the root weld. The length of the tack weld should not be less than four times the thickness of the thicker of the parts to be joined. For workpiece thicknesses over 50 mm or for high-tensile materials consideration should be given to increasing the length and thickness of tack welds. This may also include a two-pass weld. Attention should also be paid to the use of lower-tensile filler metals when welding higher-alloy steels.

Application reference

For joints that are supposed to be welded using automated or fully-mechanised processes, it is necessary to include the conditions for fabricating the tack welds in the welding procedure.

If a tack weld is to be included in a welded joint, then the shape and quality of the tack should be suitable for incorporation into the final weld. It should be fabricated by qualified welders. The tack welds should be free from cracks and prior to final welding should be cleaned thoroughly. Tack welds that exhibit cracks should be grooved out. However, crater cracks may also be removed by grinding. All tack welds that are not to be included in the final weld should be removed.

Any necessary aids that are temporarily attached for the construction or assembly of parts with fillet welds should be designed so that they can easily be removed again. The surface of the component must carefully be ground smooth again if the aid is removed by cutting or chiselling. It is possible to demonstrate by means of a dye penetrant test that the metal is not cracked in the area of the temporary weld.

Schaeffler diagram - different base materials

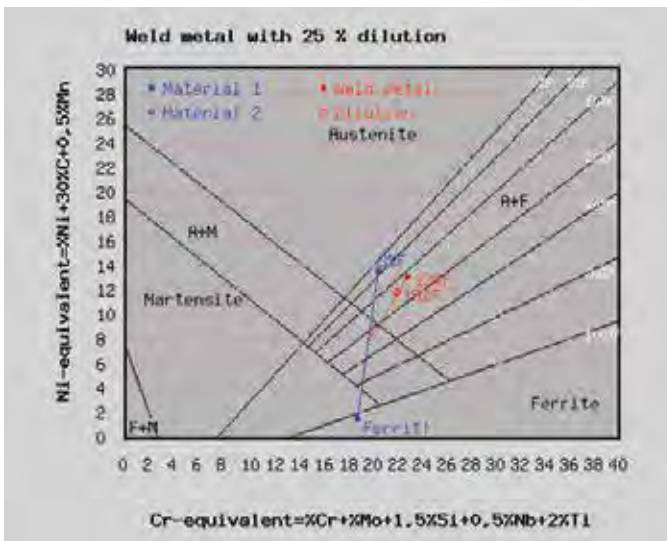

The Schaeffler diagram provides information on the welding properties of the various types of microstructure, as a function of what alloying elements they contain. Chromium equivalent is calculated using the weight percentage of ferrite stabilising elements and Nickel equivalent is calculated using the weight percentage of austenite stabilising elements. By entering the Ni-equivalent over the Cr-equivalent for stainless steel into a diagram according to Schaeffler one is able to find the content of martensite, austenite and ferrite in the resulting microstructure.

Calculation

After entering the range of the standard analysis and the actual analysis the Ni-equivalent and the Cr-equivalent are calculated and shown in a diagram.

An online calculator tool is available at www.migal.co.

3 different versions of the Schaeffler diagram are available:

- for joining two different base materials with filler metal (see example below)
- for joining two different base materials without filler metal
- for the presentation of the actual analysis and the range of the standard analysis of a certain material

Application reference

The sample data can be overwritten and the red backgrounded fields show the results.

Composition	Base material 1	Base material 2	Weld metal
Carbon C [%]	<input type="text" value="0,04"/>	<input type="text" value="0,02"/>	<input type="text" value="0,02"/>
Silicon Si [%]	<input type="text" value="0,50"/>	<input type="text" value="0,50"/>	<input type="text" value="0,80"/>
Manganese Mn [%]	<input type="text" value="0,50"/>	<input type="text" value="1,00"/>	<input type="text" value="1,00"/>
Chromium Cr [%]	<input type="text" value="17,0"/>	<input type="text" value="17,50"/>	<input type="text" value="19,00"/>
Molybdenum Mo [%]	<input type="text" value="1,10"/>	<input type="text" value="2,25"/>	<input type="text" value="2,70"/>
Nickel Ni [%]	<input type="text" value="0,00"/>	<input type="text" value="12,50"/>	<input type="text" value="12,00"/>
Niobium Nb [%]	<input type="text" value="0,00"/>	<input type="text" value="0,00"/>	<input type="text" value="0,00"/>
Titanium Ti [%]	<input type="text" value="0,00"/>	<input type="text" value="0,00"/>	<input type="text" value="0,00"/>
Chromium equivalent [%]	<input style="background-color: #f8d7da;" type="text" value=""/>	<input style="background-color: #f8d7da;" type="text" value=""/>	<input style="background-color: #f8d7da;" type="text" value=""/>
Nickel equivalent [%]	<input style="background-color: #f8d7da;" type="text" value=""/>	<input style="background-color: #f8d7da;" type="text" value=""/>	<input style="background-color: #f8d7da;" type="text" value=""/>
Dilution	<input type="text" value="25"/> [%]	Ni equivalent <input style="background-color: #f8d7da;" type="text" value=""/> [%]	Cr equivalent <input style="background-color: #f8d7da;" type="text" value=""/> [%]
<input type="button" value="Compute"/>			

De Long diagram for standard analysis

The nickel and the chromium equivalent provide information about the amount of the various structures in stainless steels. Nickel and chromium are contained in such steels in considerable amounts. Nickel creates austenite and chromium creates ferrite. By entering the Ni-equivalent over the Cr-equivalent for stainless steel into a diagram according to De Long one is able to find the content of austenite and ferrite in the resulting microstructure. In opposite to the Schaeffler diagram nitrogen is taken into consideration with the nickel equivalent. This diagram permits a more precise evaluation of the ferrite content.

Calculation

After entering the range of the standard analysis and the actual analysis the Ni-equivalent and the Cr-equivalent are calculated and shown in a diagram.

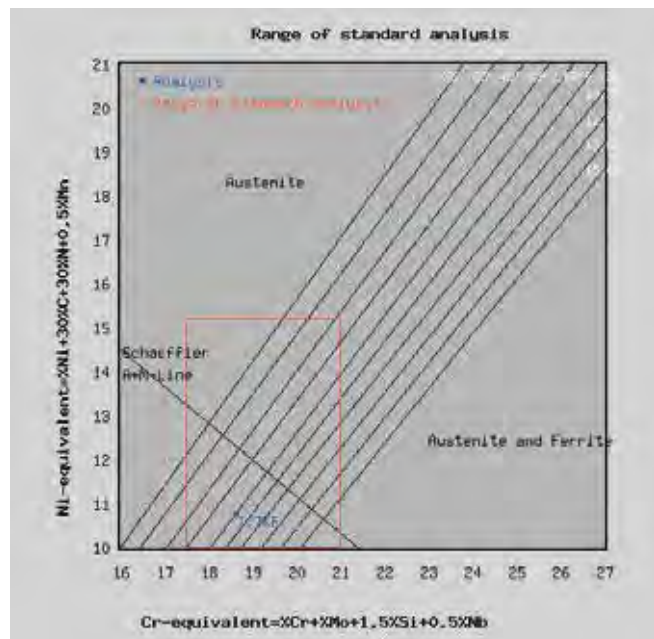

Application reference

WRC-1992 diagram for range of standard analysis

The WRC-1992 diagram provides information on the welding properties of the various types of microstructure, as a function of what alloying elements they contain. Chromium equivalent is calculated using the weight percentage of ferrite stabilising elements and Nickel equivalent is calculated using the weight percentage of austenite stabilising elements. By entering the Ni-equivalent over the Cr-equivalent for stainless steel into a diagram according to WRC one is able to find the content of austenite and ferrite in the resulting microstructure. The WRC diagram is today accepted as an improved version of the Schaeffler or the De Long diagram.

Calculation

After entering the range of the standard analysis and the actual analysis the Ni-equivalent and the Cr-equivalent are calculated and shown in a diagram.

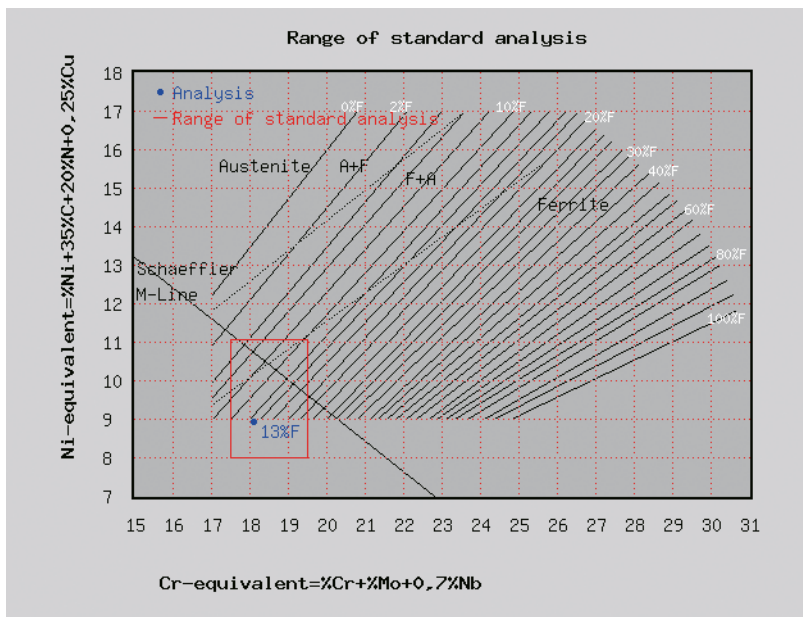

Nickel Alloys

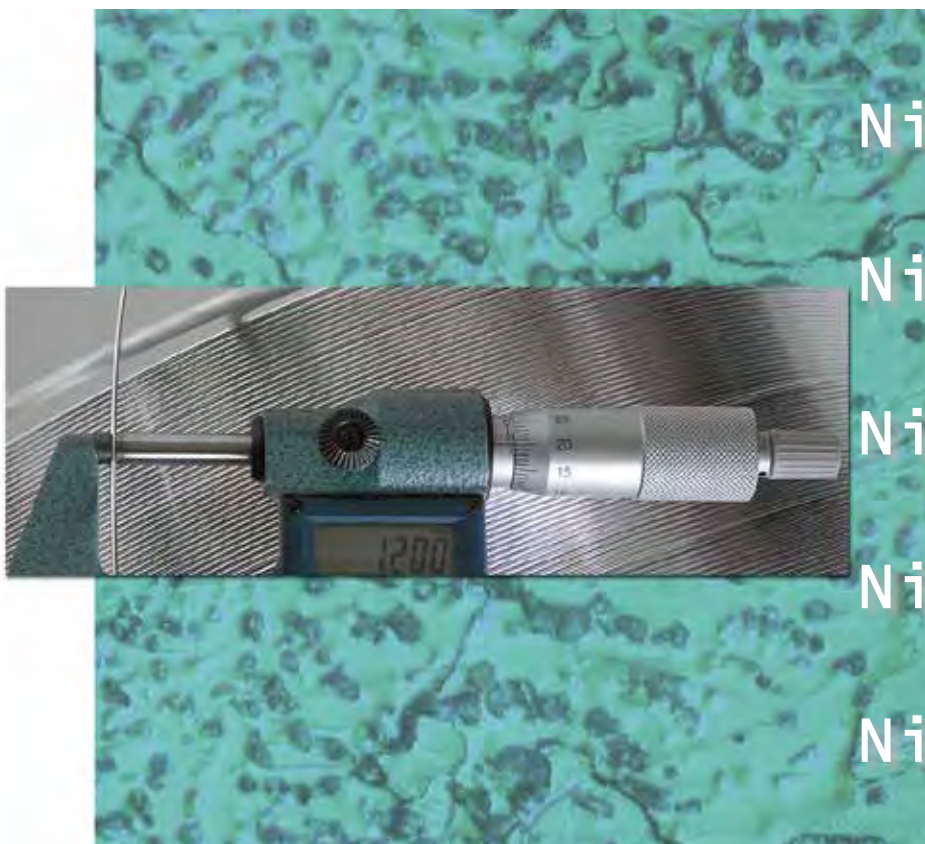

NiCr20Nb

NiCr21Mo9Nb

NiCu30MnTi

NiFe2

NiTi4

NiCr20Nb

Welding wires/rods for Nickel alloys

Typical composition in %	Ni ≥ 67,00 Cr 18,00-22,00 Fe ≤ 3,00 C ≤ 0,05 Mn 2,50-3,50 Si ≤ 0,50 Cu ≤ 0,50 Ti ≤ 0,75 Nb ≤ 3,00 S ≤ 0,015
Classification	EN ISO 18274 S Ni 6082 (NiCr20Mn3Nb) DIN 1736 SG - NiCr20Nb Material No. 2.4806 AWS A 5.14 ER NiCr-3 BS 2901 NA 35
Application	Solid nickel chrome wire electrode suitable for welding nickel alloys and joining austenitic to ferritic steels subjected to ambient temperatures exceeding 300°C and joining dissimilar materials. The weld metal is scale-resisting up to 1000°C and good toughness down to -196° C. Suitable for Austenite-Ferrite joints up to 550° C. Dissimilar joints: Ni-Base with Austenite / Ni-Base with Ferrite / Austenite with Ferrite up to 550° C
Base materials	2.4630 NiCr20Ti; 2.4631 NiCr21TiAl; 2.4669 NiCr15Fe7TiAl; 2.4816 NiCr15Fe 2.4817 LC-NiCr15Fe; 2.4851 NiCr23Fe; 2.4867 NiCr60 15; 2.4869 NiCr80 20 2.4870 NiCr 10; 2.4951 NiCr20Ti; 1.5637 12 Ni 14; 1.5662 X8Ni9; 1.5680 12Ni19 1.6900 X12CrNi18 9; 1.6901 GX8CrNi18 10; 1.6903 X10CrNiTi18 10 1.6906 X5CrNi18 10
Physical properties at 20° C (Approx. values)	Tensile strength R_m [MPa] 800 Specific electr. Resistance [Ohm mm ² /m] 1,10 Density [g/cm ³] 8,3 Melting point [°C] 1.400
Shielding gas	MIG: Ar+1-3% O ₂ , Ar+1-3% CO ₂ , Ar+He+O ₂ , Ar+He+CO ₂ , Ar+He+CO ₂ +H ₂ TIG: Ar, He, Ar+He, Ar+2-5% H ₂
Polarity	MIG =+, TIG =-
Dimensions Ø	MIG-wires [mm] 1,0; 1,2; 1,6 TIG-rods [mm] 1,6; 2,0; 2,4
Wire packagings	Spool type BS 300 / 15 kg
Rod packagings	Box 5 kg / Length 1.000 mm

NiCr21Mo9Nb

Welding wires/rods for Nickel alloys

Typical composition in %	Ni $\geq 60,00$ Cr 20,00-23,00 Fe $\leq 5,00$ C $\leq 0,10$ Mn 0,50 Si $\leq 0,50$ Cu $\leq 0,50$ Ti $\leq 0,40$ Al $\leq 0,40$ Mo 8,00-10,00 Nb 3,15-4,15 S $\leq 0,015$ P $\leq 0,02$ Co $\leq 1,00$
Classification	EN ISO 18274 S Ni 6625 (NiCr22Mo9Nb) DIN 1736 SG - NiCr21Mo9Nb Material No. 2.4831 AWS A 5.14 ER NiCrMo-3
Application	Nickel base wire electrode for welding nickel alloys and cold tough nickel steels, joining dissimilar steels and welding joints between austenitic and ferritic metals. Operating temperature -196° C bis +550° C. Dissimilar joints: Ni-Base with Austenite / Ni-Base with Ferrite / Austenite with Ferrite up to 550° C
Base materials	1.4558 X2NiCrAlTi32-20; 2.4631 NiCr20TiAl; 2.4605 NiCr23Mo16Al 2.4618 NiCr22Mo6Cu; 2.4619 NiCr22Mo7Cu; 2.4630 NiCr20Ti 2.4641 NiCr21Mo6Cu; 2.4660 NiCr20CuMo; 2.4951 NiCr; 2.4816 NiCr15Fe 2.4817 LC-NiCu15Fe; 2.4851 NiCr23Fe; 2.4856 NiCr22Mo9Nb; 2.4858 NiCr21Mo 1.4951 X6CrNi25-20; 1.5662 X8Ni9; 1.5680 X12Ni5; 1.5681 GX10Ni5 1.6907 X3CrNiN18-10; 1.6967 X3CrNiMoN18-4; 1.4876 X10NiCrAlTi32-20 1.4959 X8NiCrAlTi32-21; Alloy 800, 800HT
Physical properties at 20° C (Approx. values)	Tensile strength R_m [MPa] 800 Specific electr. Resistance [Ohm mm ² /m] 1,28 Density [g/cm ³] 8,4 Melting point [°C] 1.350 Thermal conductivity [W/m K] 9,8 Thermal expansion 20 - 100 °C [1/K] $13 \cdot 10^{-6}$ Modulus of elasticity [N/mm ²] 200.000
Shielding gas	MIG: Ar+1-3% O ₂ , Ar+1-3% CO ₂ , Ar+He+O ₂ , Ar+He+CO ₂ , Ar+He+CO ₂ +H ₂ TIG: Ar, He, Ar+He, Ar+2-5% H ₂
Polarity	MIG =+, TIG =-
Dimensions Ø	MIG-wires [mm] 1,0; 1,2; 1,6 TIG-rods [mm] 1,6; 2,0; 2,4
Wire packagings	Spool type BS 300 / 15 kg
Rod packagings	Box 5 kg / Length 1.000 mm

NiCu30MnTi

Welding wires/rods for Nickel alloys

Typical composition in %	Ni ≥ 62,00 Fe 0,50-2,50 C ≤ 0,15 Mn 2,00-4,00 Si ≤ 1,00 Cu 28,00-34,00 Ti 1,50-3,50 Al ≤ 1,00 Nb ≤ 0,50 S ≤ 0,015 P ≤ 0,02
Classification	EN ISO 18274 S Ni 4060 (NiCu30Mn3Ti) DIN 1736 SG - NiCu30MnTi Material No. 2.4377 AWS A 5.14 ER NiCu-7 BS 2901 NA 33
Application	Solid Nickel copper welding wire electrode suitable for joining nickel copper alloys and copper to steel, claddings and buffer layers.
Base materials	2.4360 NiCu 30 Fe; 2.4361 LC-NiCu 30 Fe; 2.4365 G-NiCu Nb; 2.4375 NiCu 30 Al
Physical properties at 20° C (Approx. values)	Tensile strength R_m [MPa] 550 Yield strength $R_{p0,2}$ [MPa] 250 Elongation A200 [%] 35 Hardness [HV] 135 Specific electr. Resistance [Ohm mm ² /m] 0,62 Density [g/cm ³] 8,5 Melting point [°C] 1.330
Shielding gas	MIG: Ar+1-3% O ₂ , Ar+1-3% CO ₂ , Ar+He+O ₂ , Ar+He+CO ₂ , Ar+He+CO ₂ +H ₂ TIG: Ar, He, Ar+He, Ar+2-5% H ₂
Polarity	MIG =+, TIG =-
Dimensions Ø	MIG-wires [mm] 1,0; 1,2; 1,6 TIG-rods [mm] 1,6; 2,0; 2,4
Wire packagings	Spool type BS 300 / 15 kg
Rod packagings	Box 5 kg / Length 1.000 mm

NiFe2

Welding wires/rods for Nickel alloys

Typical composition in %	Ni $\geq 53,00$ Fe Rest C $\leq 0,20$ Mn $1,00-4,00$ Si $\leq 0,30$ Cu $\leq 2,50$ Ti $0,20-0,50$ Al $\leq 0,20$ S $\leq 0,02$ P $\leq 0,02$
Classification	DIN 8573 SG - NiFe2 AWS A 5.14 ER NiFe-CI
Application	This alloy is particularly suited for welding of ferritic and austenitic nodular Cast iron as well as for joining it with non-alloy and high-alloy steel, copper and nickel alloys. Buildups on grey Cast iron qualities are also possible. Special applications are construction welding of ductile centrifugal casting tubes, such as joggles and flange joints, fittings, pumps, and for corrosion resistant claddings. The deposit is tough, crack resistant and easily machinable with cutting tools.
Physical properties at 20° C (Approx. values)	Tensile strength R_m [MPa] 800 Specific electr. Resistance [Ohm mm ² /m] 0,4 Density [g/cm ³] 8,4 Melting point [°C] 1.440
Shielding gas	MIG: Ar+1-3% O ₂ , Ar+1-3% CO ₂ , Ar+He+O ₂ , Ar+He+CO ₂ , Ar+He+CO ₂ +H ₂
Polarity	MIG =+
Dimensions Ø	MIG-Drahtelektroden [mm] 1,0; 1,2; 1,6
Wire packagings	Spool type BS 300 / 15 kg

NiTi4

Welding wires/rods for Nickel alloys

Typical composition in %	Ni ≥ 93,00 Fe ≤ 0,70 C ≤ 0,05 Mn 0,80 Si ≤ 0,80 Cu ≤ 0,20 Ti ≤ 4,00 Al ≤ 1,00 S ≤ 0,01
Classification	EN ISO 18274 S Ni 2061 (NiTi3) DIN 1736 SG - NiTi4 Material No. 2.4155 AWS A 5.14 ER Ni-1 BS 2901 NA 32
Application	Solid wire electrode suitable for welding pure nickel and nickel alloys as well as joints between these materials and steel, cast steel, copper claddings and buffer layers.
Base materials	2.4056; 2.4062; 2.4066 Nickel 200; Nickel 201; Nickel 99
Physical properties at 20° C (Approx. values)	Tensile strength R_m [MPa] 550 Yield strength $R_{p0,2}$ [MPa] 250 Elongation A200 [%] 35 Hardness [HV] 135 Specific electr. Resistance [Ohm mm ² /m] 0,29 Density [g/cm ³] 8,7 Melting point [°C] 1.430
Shielding gas	MIG: Ar+1-3% O ₂ , Ar+1-3% CO ₂ , Ar+He+O ₂ , Ar+He+CO ₂ , Ar+He+CO ₂ +H ₂ TIG: Ar, He, Ar+He, Ar+2-5% H ₂
Polarity	MIG =+, TIG =-
Dimensions Ø	MIG-wires [mm] 1,0; 1,2; 1,6 TIG-rods [mm] 1,6; 2,0; 2,4
Wire packagings	Spool type BS 300 / 15 kg
Rod packagings	Box 5 kg / Length 1.000 mm

Contents

The Company	3
Robot quality - constant products	3
MIGAL.CO Quality	4
Tolerance of diameter and surface purity	4
Twist-free wires	4
Quality control.....	5-7
Residual analysis - precision in surface coating	5
Welding robot and digital image radiography	6
Spectral analysis, tensile test and coefficient of friction	6
Standard vacuum packaging of MIGAL.CO welding wire	7
The Centre of Technology	8
The Internet	9-10
E-Commerce	9
Certificates	9
Shoplist	9
Metal supplements	10
Spools and Packaging	11-13
Overview	11
Eco-Drum	12
Jumbo-Drum	12
Physical design of the welding system when using drums	13
Indicative tables	14-21
Chemical compositions	14
Fields of application and usage of MIGAL.CO consumables for identical or similar base materials (Al)	15-16
Fields of application and usage of MIGAL.CO consumables for identical or similar base materials (Cu)	17
Fields of application and usage of MIGAL.CO consumables for identical or similar base materials (CrNi)	18-19
Lengths of wires	20
Approvals	21
Rods/Wire electrodes for Aluminium Alloys	23-34
MA-1070 • Al 99,7	24
MA-1450 • Al 99,5Ti	25
MA-2319 • AlCu6MnZrTi	26
MA-4043 • AlSi5	27
MA-4047 • AlSi12	28
MA-5087 • AlMg4,5MnZr	29
MA-5183 • AlMg4,5Mn0,7	30
MA-5356 • AlMg5Cr	31
MA-5554 • AlMg2,7Mn	32
MA-5556 • AlMg5Mn	33
MA-5754 • AlMg3	34
Application reference for Aluminium Alloys	35-46
Physical properties of chemically clean aluminium (compared to iron)	35
Effects of the differences between the physical properties of steel to aluminium on fusion welding	35
Oxide layer	36
Solubility of hydrogen	37
Surface treatment prior to welding	38
Storage and handling	38
Base materials	38
Filler materials	38

Contents

Condensation	38
Joint preparation	39
Plasma cutting	39
Machining	39
Chemical cleaning	39
Gas Metal Arc Welding of Aluminium	39-43
General Information	39
Filler metals	40
MIG welding	40
Wire feeding	41
Arc ignition	41
Insufficient melting of the base metal at start and end crater at the end of the weld	42
Black deposit on and beside the weld	42
Special attention with gas shielded arc welding	43-45
MIG welding	43
Wire scratching at metallic edges	43
Unsuitable wire feed rolls	43
Humidity and porous gas hoses	44
Contamination	44
Friction in the wire feed system	44
Arc too long	44
TIG welding	44
Preheating and inter-pass temperatures	44
Anodizing	45
Correct storage	45
Common welding defects and how to avoid them	46
Rods/Wire electrodes for Copper Alloys	47-58
ML CuAl8	48
ML CuAl8Ni2	49
ML CuAl8Ni6	50
ML CuAl9Fe	51
ML CuMn13Al7	52
ML CuNi10Fe	53
ML CuNi30Fe	54
ML CuSi28L	55
ML CuSi3	56
ML CuSn	57
ML CuSn6	58
Application reference for Copper Alloys	59-65
Arc brazing	59
General	59
Arc brazing of zinc-coated steels	59
Classification of arc brazing processes	60
GMA brazing	60
Short-arc process	60
Pulsed arc process	60
Special requirements to the brazing equipment	61
Technological remarks	61

Contents

TIG brazing	62
Special requirements to the brazing equipment	62
Plasma brazing	62
Special requirements to the brazing equipment	63
Materials for arc brazing	63
Base materials	63
Surface coatings and preparation	63
Consumables and auxiliary materials	63
Brazing consumables	63
Shielding gases	64
Joint designs	64
Occupational health	64
Laser beam brazing	65
Stainless steel welding wires/rods	67-77
Stainless steel consumables by MIGAL.CO - better than the standard	68
R&D, Know-How	68
Selection of filler metal	68
Balanced composition	68
Variants of one and the same consumable	69
Simplified stock holding	69
Delivery forms	69
1.4316 • 19.9.LSi	70
1.4332 • 24.13.LSi	71
1.4337 • ML 29.9	72
1.4370 • 18.8.Mn	73
1.4430 • 19.12.3.LSi	74
1.4462 • 22.8.3.L	75
1.4576 • 19.12.3.NbSi	76
1.4842 • ML 25.20	77
Application reference for stainless steel welding	78-82
Recommendation of shielding gases for stainless steel welding	78
Protecting the weld	78
MIG welding	78
TIG and Plasma welding	78
Root protection	79
Tips for tack welding	79
Schaeffler diagram - different base materials	80
De Long diagram for standard analysis	81
WRC-1992 diagram for range of standard analysis	82
Rods/Wire electrodes for Nickel Alloys	83-88
NiCr20Nb	84
NiCr21Mo9Nb	85
NiCu30MnTi	86
NiFe2	87
NiTi4	88
Contents	89-91

www.migal.co

MIGAL.CO GmbH

D-94405 Landau/Isar, Wattstrasse 2

Fon +49(0)9951/69 0 59-0

Fax +49(0)9951/69 0 59-3900

Email info@migal.co

Your key

to perfect wire transport.



Products

Transport devices
Drum hoods and accessories
Couplings and connectors to wire feeders
Conduits
Pneumatic feed assist
Pulley, Wire end control
Ceramic surface protection

MIGAL.CO

Index

Wire transport	4-11
Proper design of wire transport systems	4
Friction coefficient of MIGAL.CO conduits	5
Extraction force from MIGAL.CO drums	5
Calculation of transport forces for the proper design of wire transport systems	5
Wire transport for un- and low-alloy steel wires	6-7
Wire transport for high-alloy steel wires and non-ferrous alloys	8-9
Wire transport for aluminium alloys with MIGAL.CO Eco or Jumbo-Drums	10-11
Transport devices	12-13
Universal drum transport trolley UFTW 1	12-13
Drum hoods	14-15
Decoiling aids	16-20
Decoiling aid ASH 81 for Eco-drums	16-17
Installation of Eco-drums	18
Decoiling aid TOU400/580 for Jumbo-drums	19
Installation of Jumbo-drums	20
Drum connector	21
Pulley	22
Wire end control	23
Conduits	24-39
Toughliner - for un-, low- and high-alloy steel wires	24
Toughliner EXTRA - for extreme demands	25
Toughliner FLEX - extremely flexible	25
Softliner - for non-ferrous metals and high alloyed steels	26
Wall brackets for Toughliner and Softliner	27
Strain relief for Toughliner and Softliner	28
Rolliner NG - the second generation	29-31
Application, Advantages	29
Technical Data	29
Warranty	29
Delivery form	30
Perfect cutting of Softliner and Rolliner NG	31
Rolliner 3G - up to 1.6 mm wire diameter and no tools needed for assembly	32-34
Advantages, Technical Data	32
Assembly	33
Connectors, Detailed views	34
Hose holder and accessories	35
Rolliner XL2 - up to 4 mm wire diameter and no tools needed for assembly	36-39
Advantages, Technical Data	36
Connectors	36
Assembly	37
Detailed views	38
Wall bracket	39
Couplings & Connectors	40-43
Screw- and quick couplings for Rolliner NG, Rolliner 3G and Rolliner XL2	40
Coupling CRNG40 for Toughliner, Softliner, Rolliner 3G and Rolliner XL2	40-42
Connectors to wire feeders	42-43
Pneumatic feed assist DLDA1 for extreme wire feeding distances	44-45
Adapter for basket spool B 300	46
Anti spatter: Ceramic surface protection KRA-1000	47

Wire transport

Proper design of wire transport systems

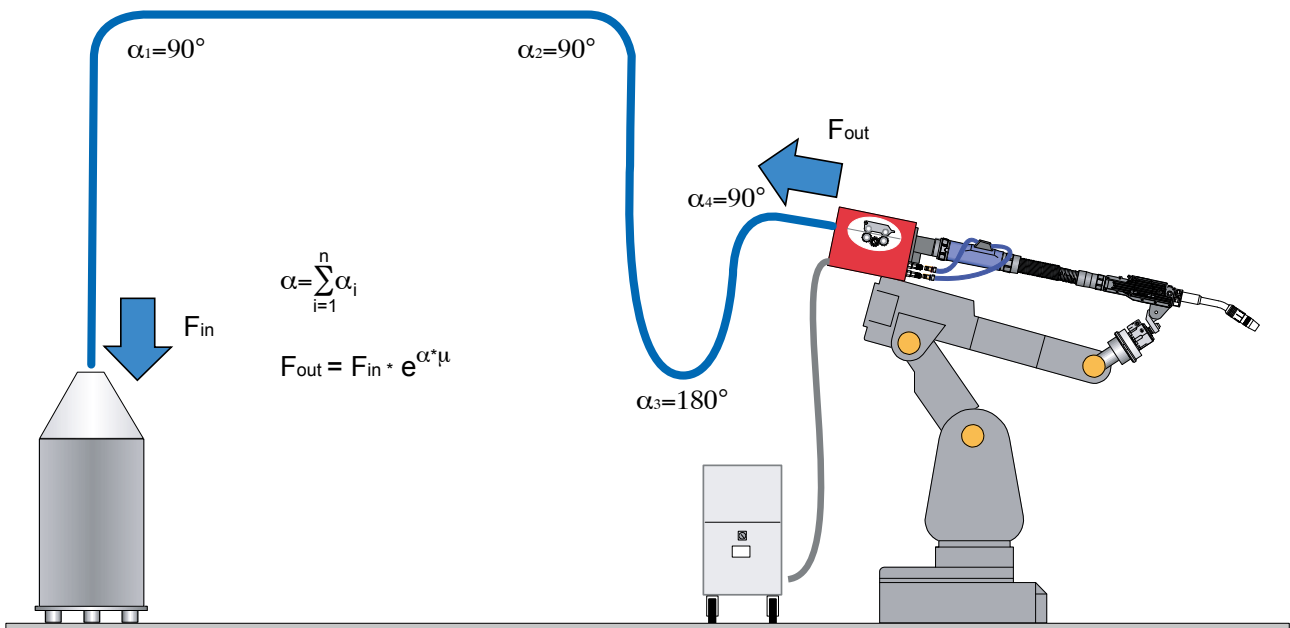

Schematic presentation of a robotic welding system with bulk wire supply

With the application of bulk wire systems (drums, large spools) instead of standard coils (7 kg in aluminum, 15 kg in steel) the use of conduits is necessary. At the same time the constancy of the wire feed speed is a crucial parameter in arc- or beamwelding. The movement of the electrode wire in the wire guide hose is inhibited by friction and it can very easily lead to situations in which the wire speed required can no longer be maintained.

Thus, the correct design of the entire wire guide system is crucial. Own research and practical experience from MIGAL.CO has shown that the formula from Euler-Eytelwein is sufficiently accurate to design wire transport systems for a stable long-term operation. The following informations are necessary:

- Required force in Newton to pull the wire out of the bulk pack
- Pulling force of the wire feeder in Newton which can be safely maintained during continuous operation
- Friction coefficient of conduit
- Sum of the radii of the conduit in degrees

The products of MIGAL.CO are uniquely matched to each other, thereby guaranteeing optimum wire transport and reliable welding processes in large scale production.

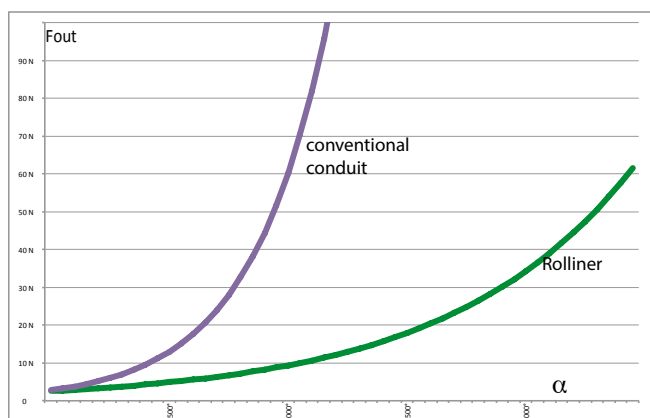

Exponential curves of two different conduits

For latest details regarding the content of this page see www.migal.co

Wire transport

Friction coefficient of MIGAL.CO conduits

Conduit	Type of friction	Friction coefficient
Rolliner 3G	Rolling friction	0.08
Rolliner XL2	Rolling friction	0.08
Toughliner	Sliding friction	0.20 *
Softliner	Sliding friction	0.20

* for steel wires only. Toughliner cannot transport aluminum wires!

Extraction force from MIGAL.CO drums

Type of drum	Extraction force [N]
Eco-drum aluminum with decoiling aid ASH 81	1.5 N (ML4043 1.6 mm)
Jumbo-drum with decoiling aid TOU400/580	1.0 N (ML5087 1.2 mm)
Eco-drum CrNi with decoiling ring	0.6 N (ML 18.8 Mn 1.2 mm)

Calculation of transport forces for the proper design of wire transport systems

With the following calculation form the application of the Euler-Eytelwein formula for designing a wire transport system is possible.

The following entries are to be made:

- Drag force in Newton - how much is for example the force required to pull the wire out of the drum (see table)
- Angle α in degrees - Sum of the bending angles with which the conduit is installed
- Friction coefficient μ (see table)

It calculates the force with which the wire feed motor has to pull. You can enter a maximum value (e. g. 30 N). The values are also displayed graphically in the diagram.

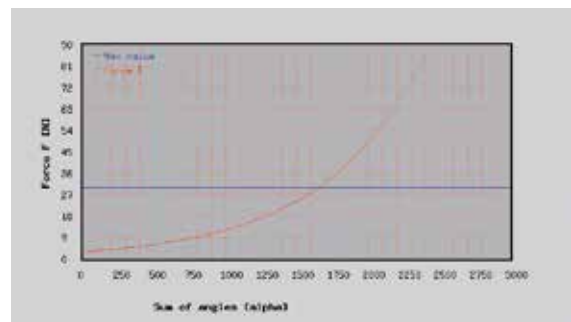

Drag force G [N]	Sum of angles α [°]	Friction coefficient μ	Maximum force F_{max} [N]	Force F [N]
<input type="text" value="3"/>	<input type="text" value="500"/>	<input type="text" value="0.08"/>	<input type="text" value="30"/>	<input type="text" value="6.03"/>
<input type="button" value="Calculate"/>				

An interactive form for the calculation of transport forces is available at www.migal.co

Wire transport for un- and low-alloy steel wires

For wire diameters up to 2.4 mm. Without Pneumatic feed assist DLDA1: Sum of the radii of the conduit

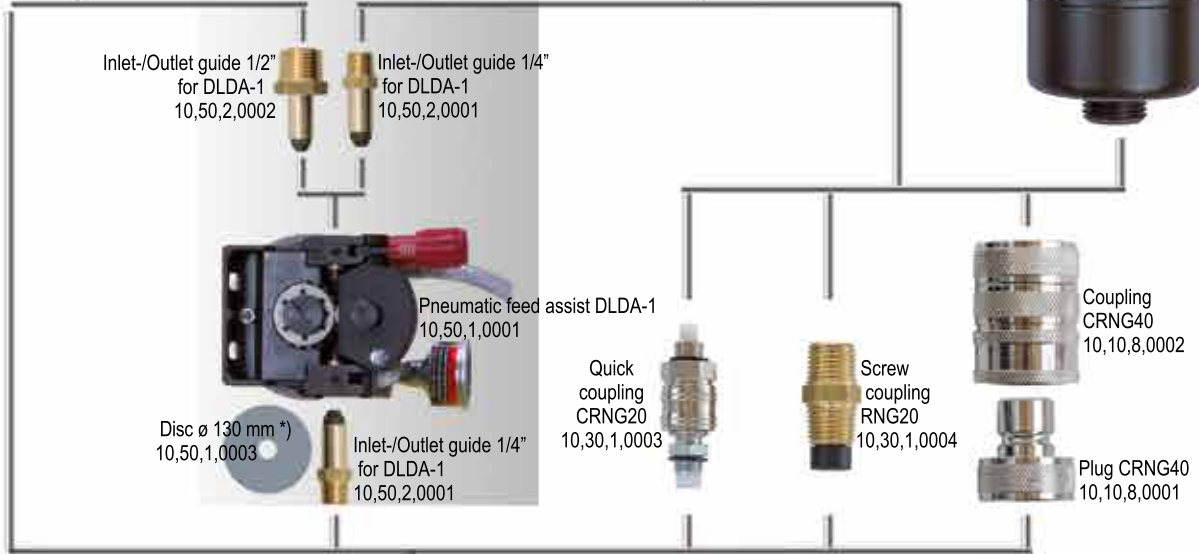

Option: Wire end control

Sensor with power cable 10,10,7,0001
 Wire end sensor block 10,10,7,0005



Connector drum hood AER201-K
10,10,5,0006



Octagonal drum hood 520 mm
10,10,2,0004
 590 mm
10,10,2,0006

Round drum hood with lip
10,10,2,0002

Square drum hood
10,10,2,0003



*) When using the Pneumatic feed assist DLDA-1, the discs delivered with the drum hood connector AER201-K must be replaced by 2 pcs. Disc ø 130 mm 10,50,1,0003.

Universal drum transport trolley UFTW1
10,10,1,0001



of the conduit $\leq 360^\circ$, Length ≤ 5 m • With DLDA1: Sum of the radii $\leq 1.800^\circ$, Length ≤ 50 m

length ≤ 25 m • With DLDA1: Sum of the radii $\leq 2.500^\circ$, Length ≤ 75 m

meters up to 1.6 mm.

Conduit $\leq 1.300^\circ$, Length ≤ 25 m

meters up to 4 mm.

er XL2 Conduit
ective hose PA12
0,20,2,0100



Rolliner 3G Conduit
with Protective hose
10,30,3,0100



Toughliner Conduit
10,40,1,0002 Toughliner (black)
10,40,1,0006 Toughliner Extra (violet)
10,40,1,0007 Toughliner Flex (yellow)



Compression
fitting CRNG40
10,10,8,0003



Plug CRNG40
10,10,8,0001



Coupling
CRNG40
10,10,8,0002



Wire outlet Rolliner XL2
with retaining clip
10,20,2,0002



Wire outlet Rolliner 3G
with retaining clip
10,30,3,0002



Adapter 1/2" - 1/4"
with internal thread
10,10,8,0006



Connector
CLOOS
19,20,1,0009



Universal connector
for wire feeders
ASRPR with brass insert
10,20,1,0013



Screw
coupling
RNG20
10,30,1,0004

Plug
CRNG40
10,10,8,0001



Coupling
CRNG40
10,10,8,0002



Connector
SKS-PF5
10,20,1,0011

Adapter 1/2" - M20
10,20,1,0014



Wire transport for high-alloy steel wires and non-ferrous alloys

For wire diameters up to 2.4 mm. Without Pneumatic feed assist DLDA1: Sum of the radii of the

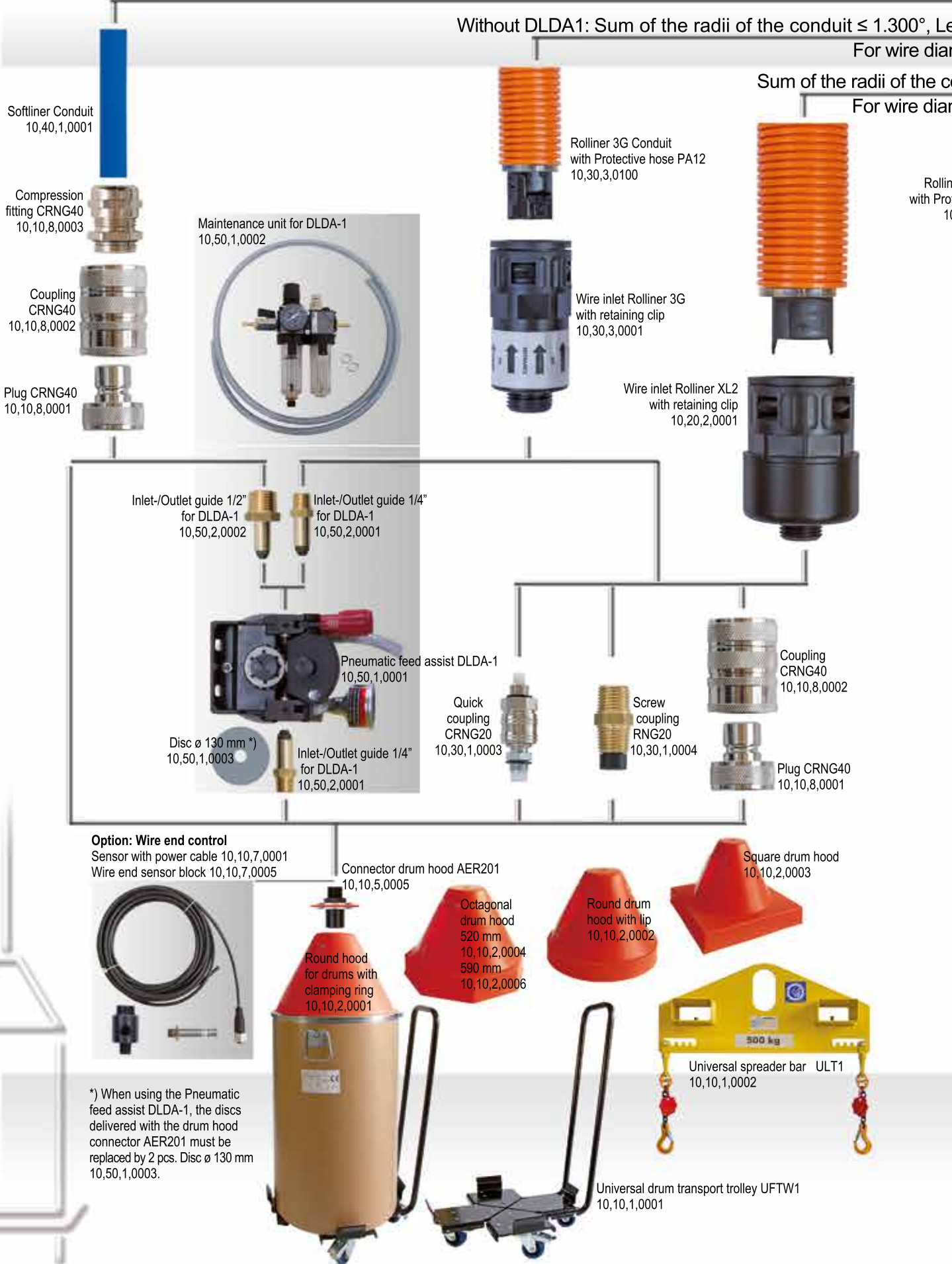

of the conduit $\leq 360^\circ$, Length ≤ 5 m • With DLDA1: Sum of the radii $\leq 1.800^\circ$, Length ≤ 50 m

length ≤ 25 m • With DLDA1: Sum of the radii $\leq 2.500^\circ$, Length ≤ 75 m
 meters up to 1.6 mm.

Conduit $\leq 1.300^\circ$, Length ≤ 25 m
 meters up to 4 mm.

er XL2 Conduit
 tective hose PA12
 0,20,2,0100



Rolliner 3G Conduit
 with Protective hose
 10,30,3,0100



Softliner Conduit
 10,40,1,0001

Compression
 fitting CRNG40
 10,10,8,0003

Plug CRNG40
 10,10,8,0001

Coupling
 CRNG40
 10,10,8,0002



Wire outlet Rolliner XL2
 with retaining clip
 10,20,2,0002



Wire outlet Rolliner 3G
 with retaining clip
 10,30,3,0002



Adapter 1/2" - 1/4"
 with internal thread
 10,10,8,0006



Connector
 CLOOS
 19,20,1,0009



Universal connector
 for wire feeders
 ASRPR with plastic insert
 10,20,1,0012



Screw
 coupling
 RNG20
 10,30,1,0004

Plug
 CRNG40
 10,10,8,0001

Coupling
 CRNG40
 10,10,8,0002



Connector
 SKS-PF5
 10,20,1,0011

Adapter 1/2" - M20
 10,20,1,0014



Wire transport for aluminium alloys with MIGAL.CO Eco- or Jumbo-

For wire diameters up to 2.4 mm. Without Pneumatic feed assist DLDA1: Sum of the radii of the conduit ≤ 1.300°, Le

Without DLDA1: Sum of the radii of the conduit ≤ 1.300°, Le

For wire diam

Sum of the radii of the co

For wire diam

Softliner Conduit
10,40,1,0001

Compression fitting CRNG40
10,10,8,0003

Coupling CRNG40
10,10,8,0002

Plug CRNG40
10,10,8,0001

Maintenance unit for DLDA-1
10,50,1,0002



Rolliner 3G Conduit with Protective hose PA12
10,30,3,0100

Wire inlet Rolliner 3G with retaining clip
10,30,3,0001

Wire inlet Rolliner XL2 with retaining clip
10,20,2,0001

Rollin with Pro 1

Inlet-/Outlet guide 1/2" for DLDA-1
10,50,2,0002

Inlet-/Outlet guide 1/4" for DLDA-1
10,50,2,0001

Insulation plate for DLDA-1
10,50,1,0004

Pneumatic feed assist DLDA-1
10,50,1,0001

Disc ø 130 mm *)
10,50,1,0003

Inlet-/Outlet guide 1/4" for DLDA-1
10,50,2,0001

Quick coupling CRNG20
10,30,1,0003

Screw coupling RNG20
10,30,1,0004

Coupling CRNG40
10,10,8,0002

Plug CRNG40
10,10,8,0001

Rolliner NG 10,30,1,0100 in required length with 2 pcs. connector ENG20S 10,30,1,0016 and 2 pcs. strain relief RES20 10,30,1,0017

Option: Wire end control
Sensor with power cable 10,10,7,0001
Wire end sensor block 10,10,7,0005



Pulley ULR-2
10,10,6,0001

Round hood for drums with clamping ring
10,10,2,0001

Square drum hood
10,10,2,0003

Decoiling aid ASH 81
10,10,3,0003

Decoiling aid TOU400/580
10,10,4,0001

Beech wooden balls 40 mm
10,10,3,0002

Universal spreader bar ULT1
10,10,1,0002

Universal drum transport trolley UFTW1
10,10,1,0001

*) When using the Pneumatic feed assist DLDA-1, the discs delivered with the decoiling aid ASH 81 must be replaced by 2 pcs. Disc ø 130 mm 10,50,1,0003.



of the conduit $\leq 360^\circ$, Length ≤ 5 m • With DLDA1: Sum of the radii $\leq 1.800^\circ$, Length ≤ 50 m

length ≤ 25 m • With DLDA1: Sum of the radii $\leq 2.500^\circ$, Length ≤ 75 m

meters up to 1.6 mm.

Conduit $\leq 1.300^\circ$, Length ≤ 25 m

meters up to 4 mm.

er XL2 Conduit
ective hose PA12
0,20,2,0100

Rolliner 3G Conduit
with Protective hose PA12
10,30,3,0100

Softliner Conduit
10,40,1,0001

Compression
fitting CRNG40
10,10,8,0003

Plug CRNG40
10,10,8,0001

Coupling
CRNG40
10,10,8,0002

Wire outlet Rolliner XL2
with retaining clip
10,20,2,0002

Wire outlet Rolliner 3G
with retaining clip
10,30,3,0002

Adapter 1/2" - 1/4"
with internal thread
10,10,8,0006



Connector
CLOOS
19,20,1,0009



Universal connector
for wire feeders
ASRPR with plastic insert
10,20,1,0012



Screw
coupling
RNG20
10,30,1,0004

Connector
SKS-PF5
10,20,1,0011



Plug
CRNG40
10,10,8,0001

Coupling
CRNG40
10,10,8,0002

Adapter 1/2" - M20
10,20,1,0014



Transport devices

Universal drum transport trolley UFTW 1

There are round, octagonal, square, small, large, light and heavy wire bulk packs. And now there is a single trolley that can deal with all these barrels without unnecessarily taking up space at the same time. UFTW 1 is adjustable by 40 mm steps in five levels, has four lockable plastic wheels and a sturdy handle.

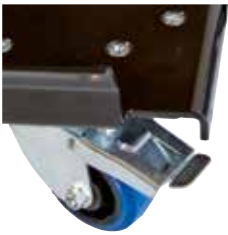

The UFTW 1 is constructed so that the drums have the largest possible contact surface precisely where it is needed - in the outer diameter range. The trolley is made from 5 mm steel and powder coated.



An empty UFTW 1 can be pushed easily by the handle.

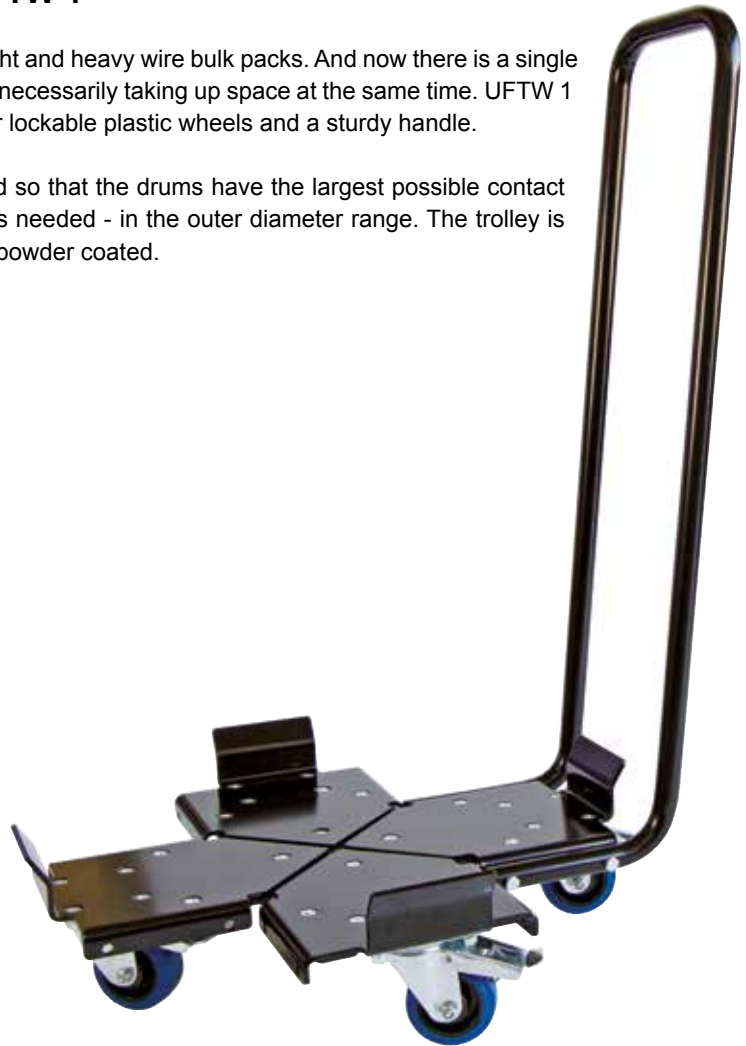

Technical Data

Maximum load	600 kg
L x B x H over all	850 x 740 x 915 mm
Product weight	18.4 kg
Roll diameter	80 mm

Overview table

Item number	Designation
10,10,1,0001	Universal drum transport trolley UFTW 1

The design sheet for the FTW1 is available at www.migal.co

Transport devices



UFTW1 in position 540 mm



UFTW1 in position 700 mm



UFTW1 with Eco-drum



UFTW1 with Jumbo-drum

For latest details regarding the content of this page see www.migal.co

Drum hoods

Drum hoods for round, octagonal and square drums

Drum hoods serve to attach the conduit and protect the drum contents from contamination. The hoods of MIGAL.CO are made of LDPE and fully recyclable. The two opposite slits are covered with a PVC window.



RND-520S
Round drum hood with lip for drums without clamping ring diameter 500 - 520 mm.



RND-520
Round hood for drums with clamping ring diameter 520 mm.



OCT-520, OCT-590
Octagonal hood for drums with 520 mm (590 mm) incircle diameter.



QUA-600
Square cap for drums with 600 mm edge length.

For latest details regarding the content of this page see www.migal.co

Drum hoods

Overview table

Item number	Designation	Dimensions	Weight
10,10,2,0001	Round drum hood for drums with clamping ring RND-520	520 mm outside diameter	1.7 kg
10,10,2,0002	Round drum hood with lip RND-520S	for drums with 500 - 520 mm outside diameter	1.7 kg
10,10,2,0003	Square drum hood QUA-600	for drums with 600 mm edge length	2.7 kg
10,10,2,0004	Octagonal drum hood OCT-520	520 mm incircle diameter	2.4 kg
10,10,2,0006	Octagonal drum hood OCT-590	590 mm incircle diameter	2.5 kg

Reference table

Manufacturer	Type	Round drum hood	Round drum hood with lip	Square drum hood	Octagonal drum hood
MIG WELD	Eco-drum aluminum- and copper alloys	x			
MIG WELD	Eco-drum CrNi		x		
MIG WELD	Jumbo-drum			x	

A reference table for drums of other manufacturers is available at www.migal.co

For latest details regarding the content of this page see www.migal.co

Decoiling aids

MIGAL.CO - decoiling aids - decades of experience for wire without knots

The wire extraction from drums and coils is fundamentally different. While coils rotate through the extraction and the wire is drawn tangentially, drums stand still and the wire is usually taken vertically upward in the axial direction.

This leads to a twist of the wire (torsion). Depending on the mechanical properties of the wire, it may cause a sudden entanglement preventing further withdrawal of the wire electrode. Such tangles are also often referred to as knots. Especially aluminum wires of alloys of the 5000 group are particularly vulnerable, but basically, this can also occur in other steel and non-ferrous alloys.

Decoiling aid ASH 81 for Eco-drums



Our ECO-drums are mainly used for aluminum alloys of the 4000 series, as well as for copper alloys. Here, our decoiling finger built-into the drum hood has been proven in conjunction with 70 wooden balls (40 mm diameter) thousands of times.

Using this decoiling finger no further connector for the conduit is necessary. The decoiling aid provides a 1/4" internal thread and a 1/2" external thread.



*Decoiling aid ASH 81
Rotating decoiling finger for integration into drum hood.*

ASH 80 built into drum hood RND-520

For latest details regarding the content of this page see www.migal.co

Decoiling aids

Overview table

Item number	Designation	Weight
10,10,3,0003	Decoiling aid ASH 81	0.9 kg
10,10,3,0004	Inlet for ASH 81	0.05 kg
10,10,3,0002	Beech wooden ball 40 mm	0.023 kg



ASH 81 Set
Necessary items for decoiling of Eco-drums.

Enlarged view of the inner rollers.

ASH 81 with Rolliner NG
The Rolliner NG which is built into the decoiling finger cares for wear free and low friction operation.

For latest details regarding the content of this page see www.migal.co

Decoiling aids

Installation of Eco-drums

1. Eco-drum in the state of delivery

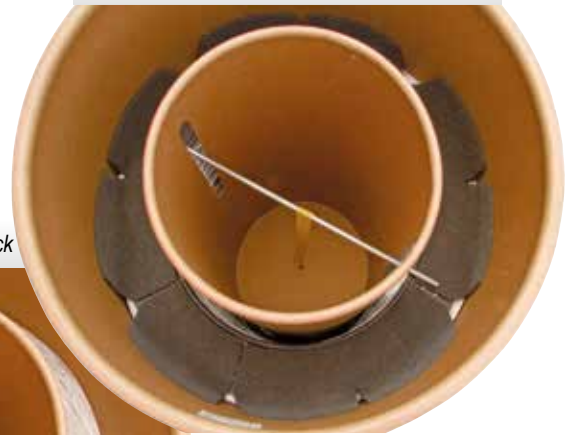

2. Eco-drum with removed transport lock



3. Eco-drum with 70 wooden balls à 40 mm diameter



4. Eco-drum ready equipped for trouble-free operation



For latest details regarding the content of this page see www.migal.co

Decoiling aids

Decoiling aid TOU400/580 for Jumbo-drums

Our jumbo drums are mainly used for aluminum alloys of the 5000 series, but also for copper alloys. Specifically the 5000 alloys are particularly prone to knot formation.



The newly developed decoiling aid of MIGAL.CO reliably prevents the formation of wire knotting. Due to the plastic ring directly sitting on the wire, the individual turns can not escape unintentionally. A rotating decoiling finger guides the wire as much as possible and avoids free loops of wire which otherwise could form knots. The decoiling finger is equipped with the Rolliner NG and therefore shows extremely low friction and wear.

During wire removal, the decoiling aid falls to the bottom of the wire drum, is withdrawn and used in the next drum.

Thus, costly downtime and system failures can be avoided. The decoiling aid is protected by the utility model DE 20 2011 108 769.0.

*TOU400/580
Decoiling aid for Jumbo packs with rotating decoiling finger.*



*TOU400/580 Set
Necessary items for decoiling of Jumbo packs (Aluminum- and copper alloys).*

Overview table

Item number	Designation	Weight
10,10,4,0001	Decoiling aid TOU400/580	1.0 kg

A video of the decoiling aid in action is available at www.migal.co

Decoiling aids

Installation of Jumbo-drums

1. Jumbo-drum in the state of delivery

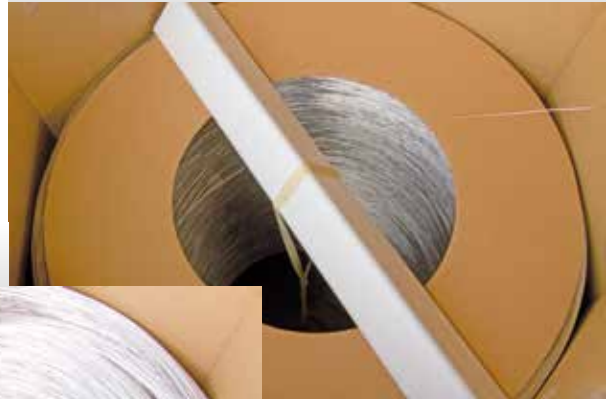

2. Jumbo-drum with removed transport lock



3. Jumbo-drum with decoiling aid



4. Jumbo-drum ready for operation

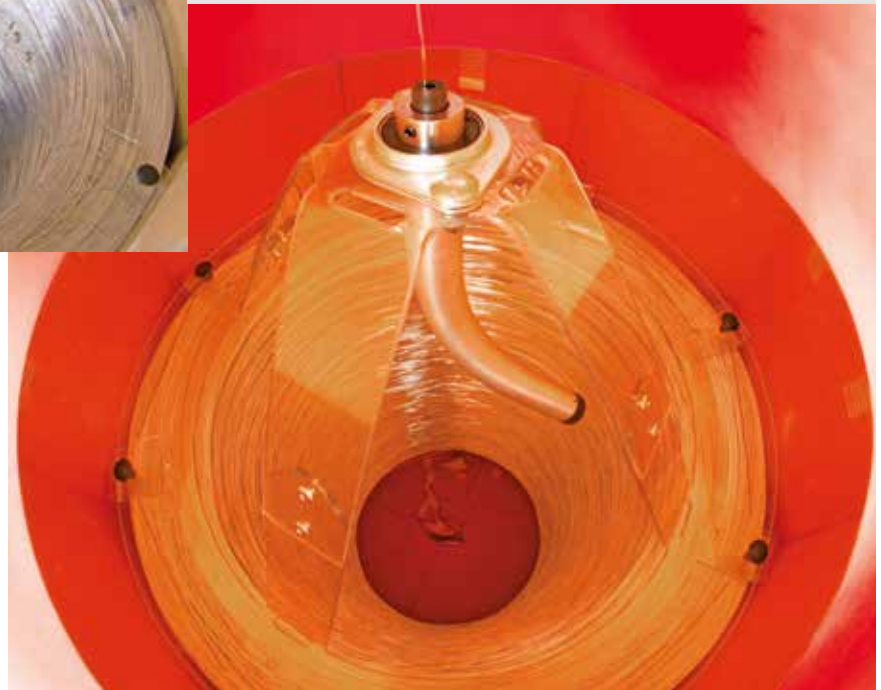

For latest details regarding the content of this page see www.migal.co

Drum connector

Connector for drum hoods

A connector is required to attach the conduit to the drum hood. This provides a 1/4" internal thread and a 1/2" external thread. All conduits from our product range can be connected. A variant with a ceramic insert is available for steel wires.



*AER201-K Inlet AER201
Inlet for Aluminum- and copper alloys (right),
and for steel with ceramic insert (left)*



Individual parts of drum connector AER 201



Inlet for drum hood complete



Sideview of the AER 201 built into drum hood

Overview table

Item number	Designation	Weight	Additional information
10,10,5,0005	Connector drum hood AER201	0.05 kg	Plastic inlet for aluminum and copper alloys
10,10,5,0006	Connector drum hood AER201-K	0.05 kg	Ceramic inlet for steel wires

For latest details regarding the content of this page see www.migal.co

Pulley

Pulley for straight welds

Wire from drums with alloys of the 5000 series is preformed sinusoidal. In mechanized welding this may lead to inaccurate positioning of the wire and specifically when small weld cross sections are welded with large wire diameters (e.g. a4 fillet weld with 1.6 mm wire diameter).

In this case, the pulley is used. This plastically deforms the wire electrode and thus the wire is pre-bent always in the same direction. The pulleys ULR-2 and ULR-3 are delivered with a quick coupling, which provides a 1/4" male thread for connection to the conduit. Attachment to the drum hood as well as a borehole for connecting the wire end control SMA-2 (10,10,7,0001) is included. The pulley ULR-3 has additionally a transparent cover to protect against dust and the wire exit leads vertically upwards.

The pull-out forces are substantial, and as follows:

- ML 5087, ML 5183, ML 5356 1.2 mm: 9 N
- ML 5087, ML 5183, ML 5356 1.6 mm: 25 N

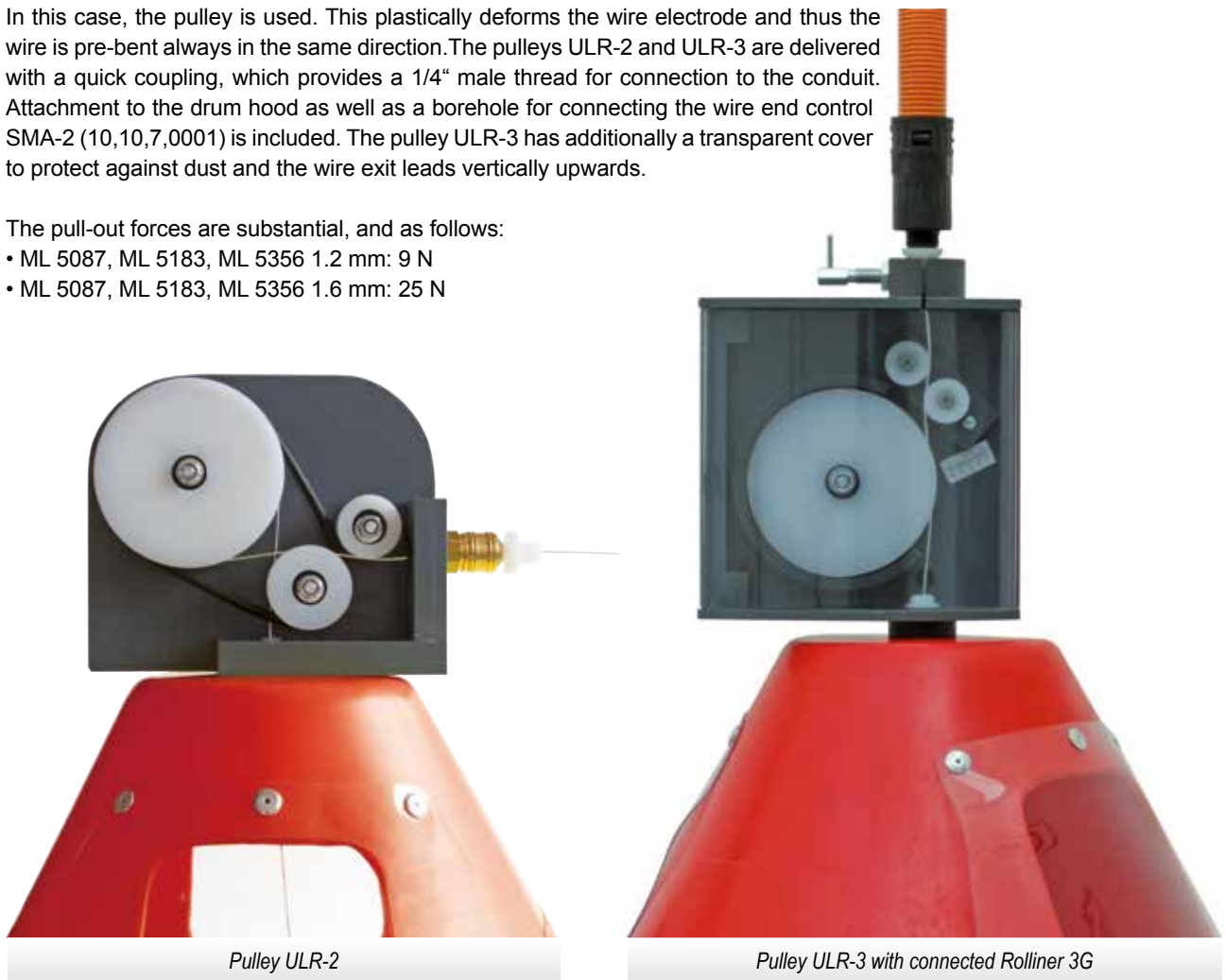

Pulley ULR-2

Pulley ULR-3 with connected Rolliner 3G

Overview table

Item number	Designation	Weight
10,10,6,0001	Pulley ULR-2	0,85 kg
10,10,6,0002	Pulley ULR-3	1,05 kg

For latest details regarding the content of this page see www.migal.co

Wire end control

End of wire clearly detected

For the detection of the wire end a non-contact sensor is available. The proximity switch is closed when welding wire is available. The operating voltage is 24 Volts. Included is the power cable (10 m), the sensor block and the proximity switch. The terminal block on the inlet side has a 1/4" male thread (connection to drum connector AER-201 or decoiling aid ASH-81) and the outlet side a 1/4" internal thread and a 1/2" external thread (connection to the conduit).



Overview table

Item number	Designation	Weight
10,10,7,0001	Sensor with power cable SMA-2	0.05 kg
10,10,7,0002	Wire end sensor block DES-2	0.03 kg

A data sheet of the sensor is available at www.migal.co

Conduits

Toughliner - for un-, low- and high-alloy steel wires

Toughliner is the conduit with extremely high wear resistance and low coefficient of friction at the same time.



The spiral is made of flat steel wire with rounded edges and a tensile strength of more than 1,500 N/mm². The tube is encased in two layers with PE inside and outside with PA12. This gives an excellent durability, achieved even under extreme conditions. The hose is so stiff on one hand, that it always sets the largest possible bending radius (as shown on photograph page 20) and yet so flexible that even strong robot movements over a long time can be tolerated.

With the coupling CRNG40 the Tough liner is connected without interfering transitions.



Toughliner detail with quick coupling CRNG40



Toughliner with plug CRNG40
The Toughliner is completely passed through the coupling, and the wire doesn't touch the coupling at any point. The Toughliner is directly connected by the coupling and there are no problems during wire inching.



Toughliner with quick coupling CRNG40
The Toughliner is completely passed through the coupling, and the wire doesn't touch the coupling at any point. The Toughliner is directly connected by the coupling and there are no problems during wire inching.

Technical data Toughliner, Extra, Flex

Weight of product	0.25 kg/m
Coefficient of friction	0.20
Outside-/Inside diameter	11.7 mm / 5.7 mm
Diameter of welding wire	up to 2.4 mm

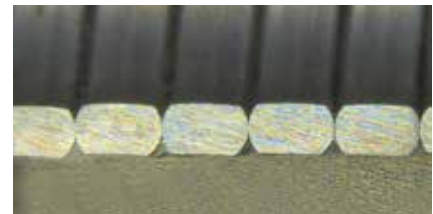

Section Toughliner
The Toughliner is made of flat rolled round wire. Thus, the edges are rounded and sharp edges are avoided.

For latest details regarding the content of this page see www.migal.co

Conduits

Toughliner EXTRA - for extreme demands

Toughliner Extra is built of a flat steel wire with rounded edges and an additional fortification with longitudinal wires. This allows Toughliner Extra to withstand extreme tensile stress. The couplings CRNG40 may be used the same way as with Toughliner.



Structure of Toughliner EXTRA



Cross section of Toughliner EXTRA

Toughliner FLEX - extremely flexible

Toughliner Flex consists of a round wire spiral with a soft sheathing and is thus extremely flexible. Toughliner Flex can be used in areas with extreme flexibility requirements. The couplings CRNG40 may be used the same way as with Toughliner.



Structure of Toughliner FLEX



extremely flexible

Overview table

Item number	Designation	Weight
10,40,1,0002	Conduit Toughliner	0.25 kg/m
10,10,7,0006	Conduit Toughliner EXTRA	0.25 kg/m
10,10,7,0007	Conduit Toughliner FLEX	0.25 kg/m

For latest details regarding the content of this page see www.migal.co

Conduits

Softliner - for non-ferrous metals and high alloyed steels

Softliner is a polyethylene conduit with high density, low coefficient of friction and good durability.



Softliner is used for welding consumables from aluminum and copper alloys and high-alloy steels. The hose is so stiff on one hand, that it always sets the largest possible bending radius and yet so flexible that even strong robot movements over a long time can be tolerated.

With the coupling CRNG40 the Softliner is connected without interfering transitions.



Softliner detail with quick coupling CRNG40

*Softliner with plug CRNG40
The Softliner is completely passed through the coupling, and the wire doesn't touch the coupling at any point. The Softliner is directly connected by the coupling and there are no problems during wire inching.*



*Softliner with quick coupling CRNG40
The Softliner is completely passed through the coupling, and the wire doesn't touch the coupling at any point. The Softliner is directly connected by the coupling and there are no problems during wire inching.*

Technical data

Weight of product	0.05 kg/m
Coefficient of friction	0.20
Outside-/Inside diameter	11.7 mm / 7.7 mm
Diameter of welding wire	up to 2 mm

Overview table

tem number	Designation
10,40,1,0001	Conduit Softliner



*Cutting tool Cutty
The Softliner can be easily and precisely cut by our cutting tool Cutty.*

For latest details regarding the content of this page see www.migal.co

Conduits

Wall brackets for Toughliner and Softliner

For the attachment of Toughliner, Toughliner Extra, Toughliner Flex and Softliner to a wall a suitable bracket is available. The internal thread is M6.

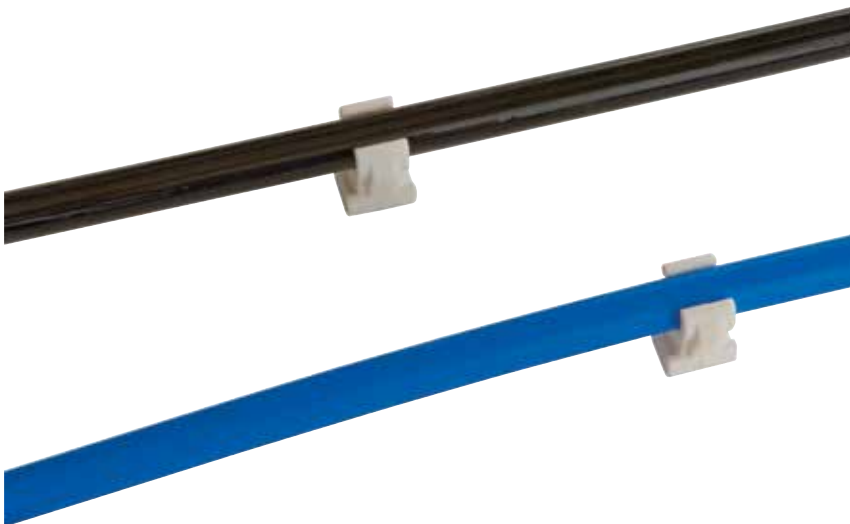

Wall bracket for Toughliner and Softliner side view

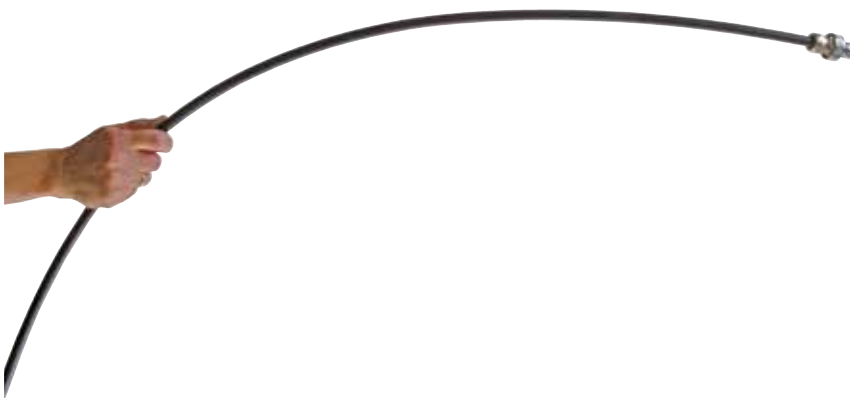

The Toughliner is stiff enough for a uniform bend radius.



Wall bracket for Toughliner and Softliner topview

Overview table

Item number	Designation	Weight
10,40,1,0005	Wall bracket for Toughliner and Softliner	0.01 kg

For latest details regarding the content of this page see www.migal.co

Conduits

Strain relief for Toughliner and Softliner

Kinking of the conduit directly behind the connection can be avoided. The strain relief is recommended for extremely fast robot movements.

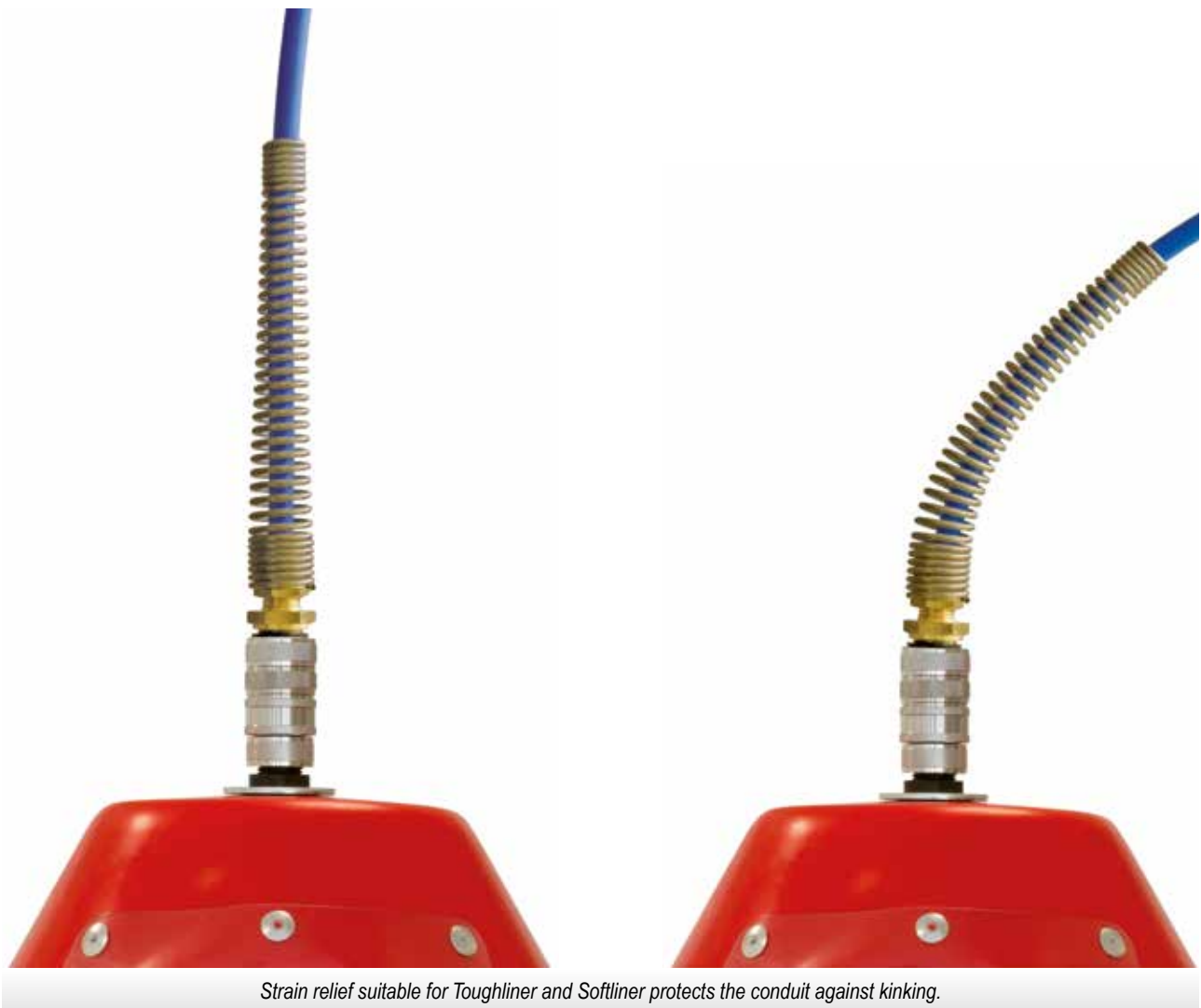

Overview table

Item number	Designation	Weight
10,40,1,0003	Strain relief for Softliner and Toughliner	0.25 kg

For latest details regarding the content of this page see www.migal.co

Conduits

Rolliner NG - the second generation

ROLLINER NG is the second generation of a completely new approach to wire feeding.

Away from friction in liners, away from abrasion, from fluctuating feeding and from unnecessary maintenance. With ROLLINER feeding occurs through rolls only, shifted by 90° - without any sliding friction. ROLLINER NG has a diameter of 20 mm and may be shortened or lengthened easily – without any tools. The maximum bending radius is 120 mm and the weight was substantially reduced – ideal for highly dynamic movements.

ROLLINER NG is the ultimate solution for any wire feeding!

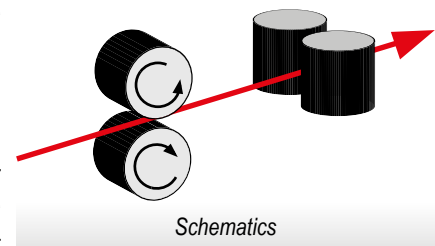

Schematics

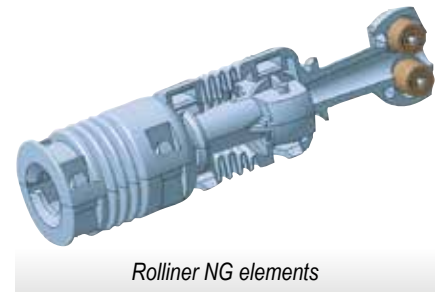

Rolliner NG elements

Application

- Connecting bulk-wire systems to the wire-feeder
- Connecting wire-feeders to welding guns

Advantages

- No abrasion due to extremely small forces on the wire
- Reduced cost due to the reduction to one wire drive only, and no maintenance necessary
- Stable arc due to precise wire feeding
- Simplified setup of welding systems due to more freedom in situating the bulk-wire system

Technical data

Outside diameter	20 mm
Weight / meter	150 grams
Min. bending radius for wire inching	150 mm
Min. bending radius	120 mm
Maximum torsion	180° / meter
Max. inner diameter	2 mm (wire 1.6)
Recommended wire diameter	0.6 - 1.2 mm
Length per packaging unit	25 m
Coefficient of friction	0.08

Warranty

For Rolliner we provide a warranty of 1 year!

For latest details regarding the content of this page see www.migal.co

Conduits

Rolliner NG - the second generation

Delivery form

ROLLINER NG is supplied by the meter. The required connectors can be easily fitted by the user. The connector ENG20S represents a 1/4" female thread. For the connection to the drum hood connector AER-200 either a screw connector RNG20 or a quick connector CRNG20 is required. Alternatively, the wire end control (page 17) can be used.

For the connection to the wire feeder by the universal connector ASR-PR no additional coupling is required.

Note: The connector ENG20S with strain relief RES20 replaces the earlier product ENG20!



Rolliner NG with connector ENG20S, strain relief RES20, quick coupling CRNG20, connector drum hood AER201.



Rolliner NG in standard configuration with connector ENG20S and strain relief RES20.

For latest details regarding the content of this page see www.migal.co

Conduits

Rolliner NG - the second generation



Connector ENG20S

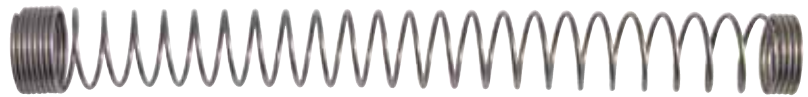

Strain relief RES20

Overview table

Item number	Designation	Weight
10,30,1,0100	Rolliner NG	0.15 kg/m
10,30,1,0016	Connector ROLLINER NG ENG20S	0.04 kg
10,30,1,0017	Strain relief for Rolliner NG RES20	0.05 kg

Perfect cutting of Softliner and Rolliner NG

For cutting of Softliner and Rolliner NG the cutting tool CTY1 is available. It makes perfect cuts in no time.



Overview table

Item number	Designation	Weight
10,40,1,0004	Cutty - cutting tool for Rolliner and Softliner	0.05 kg

For latest details regarding the content of this page see www.migal.co

Conduits

Rolliner 3G - up to 1.6 mm wire diameter and no tools needed for assembly

Rolliner 3G is the continuation of the roll-guided wire feed hose, which has been successful for 10 years, with significant improvements. The individual elements contain a pair of rollers and are connected to one another via joints. Each element is turned by 90 ° to the adjacent element, whereby the welding wire is guided entirely by rollers. As a result, the friction is significantly reduced in comparison to conventional wire guide hoses. Between the individual pairs of rollers there is a conical guide, which during threading leads the wire to the next pair of rollers, thus ensuring trouble-free threading over narrow radii.

Effortless threading by means of a patented, conical guide of the wire from roller pair to roller pair!



Advantages

- Due to its low friction, Rolliner 3G allows significantly longer wire runs between the pay-off pack and the wire feeder. In many cases it is possible to avoid additional drives.
- Rolliner 3G is not a wearing part and is maintenance-free for many years. The welding process becomes more stable as less slippage occurs due to the low forces in the wire transport system.
- Rolliner 3G can be shortened or extended without tools. For shorting the use of a separation tool is recommended.

Technical Data

Lengths	any - maximum length of protective hose 25 m, can be extended with hose connector
Outside diameter	28.5 mm
Bending radius	minimum 70 mm at wire threading and during operation
Maximum wire diameter	1.6 mm
Conveyable alloys	all material types can be transported by Rolliner 3G (round wires), i. e. steel, stainless steel, aluminum, copper, etc.
Maximum wire feed speed	30 meters per minute
Weight per meter	200 grams
Wire temperature	max. 40° Celsius
Coefficient of friction	0.08

For latest details regarding the content of this page see www.migal.co

Conduits

Rolliner 3G - up to 1.6 mm wire diameter and no tools needed for assembly

Overview table

Item number	Designation	Weight
10,30,3,0001	Connector wire inlet Rolliner 3G with retaining clip	0.05 kg
10,30,3,0002	Connector wire outlet Rolliner 3G with retaining clip	0.05 kg
10,30,3,0003	Retaining clip Rolliner 3G	0.004 kg
10,30,3,0100	Rolliner 3G with protective hosePA12	0.2 kg/m
10,20,2,0004	Connector protective hose PA12 Rolliner 3G	0.03 kg
10,40,2,0001	Separation tool Rolliner 3G	0.05 kg
10,30,1,0003	Quick coupling CRNG20 complete (plug and coupling)	0.08 kg
10,10,8,0001	Plug CRNG40	0.07 kg
10,10,8,0002	Coupling CRNG40	0.16 kg



Rolliner 3G without protective hose, view of single element



Arrows on each element of the Rolliner 3G show the wire feed direction as well as the insertion direction

Easy assembly

- Insert elements into protective hose
- Insert the holding clips at the inlet and outlet
- Connect the wire inlet and outlet



Rolliner 3G elements without protective hose

For latest details regarding the content of this page see www.migal.co

Conduits

Rolliner 3G - up to 1.6 mm wire diameter and no tools needed for assembly

Connectors

The inlets and outlets of the Rolliner 3G have a 1/4" internal thread and a 1/2" external thread. As a result, the CRNG20 or CRNG40 quick couplings can be used.

For an overview of all couplings with fotos and item numbers see page 40.



Rolliner 3G complete with protective hose connector and quick coupling CRNG 40



Separation tool in a correct position



Retaining clip Rolliner 3G



Wire inlet Rolliner 3G



Wire outlet Rolliner 3G

For latest details regarding the content of this page see www.migal.co

Conduits

Hose holder and accessories

For Rolliner NG, Rolliner 3G, as well as the protective hose PA12 suitable brackets and wear rings are offered.

Overview table

Item number	Designation	Weight
10,30,1,0008	Wall bracket for Rolliner NG SNG20	0.02 kg
10,30,1,0010	Wall bracket for protective hose PA12	0.05 kg
10,30,1,0009	Wear ring for protective hose PA12	0.02 kg
10,30,1,0014	Hose holder for Rolliner NG, 3G and protective hose PA12	0.1 kg



Wall bracket for protective hose PA12



Wall bracket for Rolliner NG SNG20



Wear ring for protective hose PA12



Hose holder for Rolliner NG and protective hose PA12



For latest details regarding the content of this page see www.migal.co

Conduits

Rolliner XL2 - up to 4 mm wire diameter and no tools needed for assembly

Rolliner XL2 is the continuation of the roll-guided wire feed hose, which has been successful for 10 years, with significant improvements. The individual elements contain a pair of rollers and are connected to one another via joints. Each element is turned by 90 ° to the adjacent element, whereby the welding wire is guided entirely by rollers. As a result, the friction is significantly reduced in comparison to conventional wire guide hoses. Between the individual pairs of rollers there is a conical guide, which during threading leads the wire to the next pair of rollers, thus ensuring trouble-free threading over narrow radii.

Effortless threading by means of a patented, conical guide of the wire from roller pair to roller pair!

Advantages

- Due to its low friction, Rolliner XL2 allows significantly longer wire runs between the pay-off pack and the wire feeder. In many cases it is possible to avoid additional drives.
- Rolliner XL2 is not a wearing part and is maintenance-free for many years. The welding process becomes more stable as less slippage occurs due to the low forces in the wire transport system.
- Rolliner XL2 can be shortened or extended without tools.

Technical Data

Lengths	any - maximum length of protective hose 25 m, can be extended with hose connector
Outside diameter	42.5 mm (55 mm at the connectors)
Bending radius	minimum 150 mm at wire threading and during operation
Maximum wire diameter	4 mm
Conveyable alloys	all material types can be transported by Rolliner XL2 (round wires), i. e. steel, stainless steel, aluminum, copper, etc.
Maximum wire feed speed	30 meters per minute
Weight per meter	500 grams
Wire temperature	maximum 40° Celsius
Coefficient of friction	0.08

Connectors

The inlets and outlets of the Rolliner XL2 have a 1/4" internal thread and a 1/2" external thread. As a result, the CRNG20 or CRNG40 quick couplings can be used. For an overview of all couplings with fotos and item numbers see page 40.

For latest details regarding the content of this page see www.migal.co



Conduits

Rolliner XL2 - up to 4 mm wire diameter and no tools needed for assembly

Overview table

Item number	Designation	Weight
10,20,2,0001	Connector wire inlet Rolliner XL2 with retaining clip	0.1 kg
10,20,2,0002	Connector wire outlet Rolliner XL2 with retaining clip	0.1 kg
10,20,2,0003	Retaining clip Rolliner XL2	0.004 kg
10,20,2,0100	Rolliner XL2 with protective hose PA12	0.5 kg/m
10,30,3,0004	Connector protective hose PA12 Rolliner XL2	0.03 kg
10,30,1,0003	Quick coupling CRNG20 complete (plug and coupling)	0.08 kg
10,10,8,0001	Plug CRNG40	0.07 kg
10,10,8,0002	Coupling CRNG40	0.16 kg

Easy assembly

- Insert elements into protective hose
- Insert the holding clips at the inlet and outlet
- Connect the wire inlet and outlet



Rolliner XL2 Elements



Arrows on each element of the Rolliner XL2 show the wire feed direction as well as the insertion direction

For latest details regarding the content of this page see www.migal.co

Conduits

Rolliner XL2 - up to 4 mm wire diameter and no tools needed for assembly



Retaining clip Rolliner XL2



Wire inlet and wire outlet with retaining clip



Hose connector for PA 12



Wire inlet Rolliner XL2



Wire outlet Rolliner XL2



Rolliner XL2 with quick coupling CRNG40

For latest details regarding the content of this page see www.migal.co

Conduits

Rolliner XL2 - up to 4 mm wire diameter and no tools needed for assembly

Wall bracket

By means of a wall bracket the Rolliner XL2 can be attached to a wall.



Wall bracket Rolliner XL2 sideview



Wall bracket Rolliner XL2 diagonal view

Overview table

Item number	Designation	Weight
10,20,2,0005	Wall bracket for Rolliner XL2	0.02 kg

For latest details regarding the content of this page see www.migal.co

Couplings & Connectors

Screw- and quick couplings for Rolliner NG, Rolliner 3G and Rolliner XL2

These couplings are used to connect the Rolliner NG with the drum hood connector AER-201 or the wire end control. A plastic insert protects the wire against damage. It must be inserted in the direction of the wire transport. The outer thread is 1/4".



Screw coupling RNG20



Quick coupling CRNG20



Quick coupling CRNG20 divided

Overview table

Item number	Designation	Weight
10,30,1,0004	Screw coupling RNG20	0.025 kg
10,30,1,0003	Quick coupling CRNG20	0.08 kg

Coupling CRNG40 for Toughliner, Softliner, Rolliner 3G and Rolliner XL2

The coupling CRNG40 is used to connect the conduits Toughliner, Softliner, Rolliner 3G or Rolliner XL2.

The special feature of this coupling is that the wire can never touch the metal parts of the coupling. This is achieved by the fact that the conduits are directly routed through the coupling and face each other nearly without a gap. The coupling provides a 1/2" internal thread. Softliner or Toughliner are fixed by a compression fitting.

For latest details regarding the content of this page see www.migal.co

Couplings & Connectors

Coupling CRNG40 for Toughliner, Softliner, Rolliner 3G and Rolliner XL2

Overview table

Item number	Designation	Weight
10,10,8,0001	Plug CRNG40	0.07 kg
10,10,8,0002	Coupling CRNG40	0.16 kg
10,10,8,0003	Compression fitting CRNG40	0.03 kg
10,10,8,0006	Adapter 1/2"-1/4" with internal thread	0.07 kg

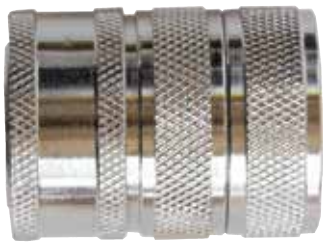

Coupling CRNG40



Plug CRNG40



Compression fitting CRNG40



*Adapter 1/2" - 1/4" with internal thread
Connects to various connectors for wire
feeders.*

For latest details regarding the content of this page see www.migal.co

Couplings & Connectors

Coupling CRNG40 for Toughliner, Softliner, Rolliner 3G and Rolliner XL2



Quick coupling CRNG40 with Softliner on drum hood.



Plug CRNG40 on drum hood.

Connectors to wire feeders

To connect the Rolliner, as well as Softliner and Toughliner various fittings to wire feeders are available.



Connector for wire feeders ASRPR with plastic insert
Fits for Fronius, EWM, Lorch, Rehm, Kemppi (9,5/11,5/12/13 mm).
Suitable for aluminum- and copper alloys.

Universal connector for wire feeders ASRPR brass
Suitable for Fronius, EWM, Lorch, Rehm, Kemppi
(9,5/11,5/12/13 mm). For steel wires only.

For latest details regarding the content of this page see www.migal.co

Couplings & Connectors

Connectors to wire feeders



Connector CLOOS



Connector SKS-PF5



Connector SKS-Q591D



Adapter 1/2" to M20

Reference and overview table

Item number	Designation	Fits for	Weight	Additional information
10,20,1,0012	Universal connector for wire feeders ASRPR with plastic insert	Fronius, EWM, Lorch, Rehms	0.07 kg	for non ferrous metals
10,20,1,0013	Universal connector for wire feeders ASRPR with brass insert	Fronius, EWM, Lorch, Rehms	0.07 kg	for steels
10,20,1,0014	Adapter 1/2" to M20	Fronius	0.007 kg	
10,20,1,0009	Connector CLOOS	CLOOS	0.005 kg	all alloys
10,20,1,0011	Connector SKS PF5	SKS PF5	0.05 kg	all alloys
10,20,1,0010	Connector SKS Q591D	SKS Q591D	0.05 kg	all alloys

For latest details regarding the content of this page see www.migal.co

Wire feeder

Pneumatic feed assist DLDA1 for extreme wire feeding distances

The friction of the wire in the conduit is caused by the fact that the wire rests against the inside of the tube. This grows exponentially with the bending angle and, depending on the coefficient of friction rapidly to a complete blocking of the wire electrode.

The pneumatic feed assist DLDA1 exerts a permanent and continuously adjustable pressure to the wire electrode. The latter is pressed against the outer wall of the conduit, where it causes about the same friction as otherwise against the inner wall. Ideally, the air pressure is adjusted so that the wire at the outlet of the conduit may be pulled or blocked with just two fingers (few Newtons). The wire feeder can then supply any quantity of wire with the least amount of force.

The Euler-Eytelwein formula fails here. However, approximately the double angle can be achieved by using the DLDA1.

The DLDA1 can either be placed on the drum hood with the connector AER200 or decoiling aid ASH-80, or just snapped in between the conduit (Toughliner, Softliner, Rolliner). The coupling CRNG40 is provided for standard use with the DLDA1.



*Pneumatic feed assist DLDA-1 on drum hood
Using the inlet guide 1/4" the pneumatic feed assist
connects to the drum connector AER-201
or the decoiling finger ASH-81.*

Technical data

Wire feed speed	0 - 30 m/min
Feeding force	0-60 N (adjustable by air pressure 0-6 Bar)
Dimensions L x B x H	100 x 140 x 160 mm
Weight	5.1 kg
Wire diameter	0.8 - 1.6 mm
Air consumption	approx. 20 - 30 cbm/h

For latest details regarding the content of this page see www.migal.co

Wire feeder

Pneumatic feed assist DLDA1 for extreme wire feeding distances

Overview table

Item number	Designation	Weight
10,50,1,0001	Pneumatic feed assist DLDA-1	5.1 kg
10,50,1,0002	Maintenance unit for DLDA-1	0.9 kg
10,50,2,0001	Inlet/outlet guide 1/4" für DLDA-1	0.02 kg
10,50,2,0002	Inlet/outletguide 1/2" für DLDA-1	0.04 kg
10,50,3,0008	Set feed rolls 0,8 mm Fe	0.11 kg
10,50,3,0010	Set feed rolls 1,0 mm Fe	0.11 kg
10,50,3,0012	Set feed rolls 1,2 mm Fe	0.11 kg
10,50,3,0016	Set feed rolls 1,6 mm Fe	0.11 kg
10,50,4,0008	Set feed rolls 0,8 mm Al	0.11 kg
10,50,4,0010	Set feed rolls 1,0 mm Al	0.11 kg
10,50,4,0012	Set feed rolls 1,2 mm Al	0.11 kg
10,50,4,0016	Set feed rolls 1,6 mm Al	0.11 kg



Pneumatic feed assist DLDA-1 with conduit in in- and outlet



*Inlet/outlet guide 1/2" for DLDA-1
The quick connector CRNG-40 connects to the DLDA-1 with the inlet guide 1/2".*



*Inlet/outlet guide 1/4" for DLDA-1
Connects to the drum connector AER-201, the decoiling finger ASH-81 or to the Rolliner.*

For latest details regarding the content of this page see www.migal.co

Basket spool adapters

Adapters - for basket spools

Adapters are required for some applications and some spool. Additionally to the shown variants we also have the option for custom designs. Please contact us.

Adapter for basket spool B 300

The wire basket B-300 is very environmentally friendly as it can easily be disposed as scrap steel. With this adapter, the wire basket can be attached to the common 52 mm mandrel of all standard wire feeders.

The adapter is easy to put together using zip closure. All basket spools B 300 according to EN ISO 544:2011 can be used.



Overview table

Item number	Designation	Weight
10,70,1,0001	Adapter for basket spool B 300	0,8 kg

For latest details regarding the content of this page see www.migal.co

Anti spatter

Ceramic surface protection KRA-1000 for fixtures and welding torches

The ceramic surface protection spray KRA-1000 protects surfaces exposed to temperatures up to 1000° C. The lifetime of MSG gas nozzles and contact tubes, electrodes of resistance welding machines and outlet nozzles of cold wire feeders for laser and plasma welding will be prolonged significantly. Surfaces of welding fixtures and clamping elements are optimally protected from weld spatter or other sparks.

Benefits

- Spatter will either stick not to the surface or will be much easier to remove from nozzles or fixtures
- Less downtime and maintenance costs due to less frequent cleaning
- Up to ten times lifetime of nozzles and devices
- Stable welding processes, and thus less scrap



Samples of gas nozzles and contact tips with ceramic coating

Application

Shake the can for at least 30 seconds before each use. Spray a thin film from a distance of approx. 30 cm. Avoid repeated overspray and consequent thick layers.

Allow sprayed film to dry before use for 30 seconds!



Warning

- Extremely flammable. Keep away from open flames or other sources!
- Irritating to eyes and mucous membranes
- Pressurized container
- Skin contact may cause skin dryness or cracking
- Inhalation of vapors may cause drowsiness and dizziness
- Do not expose aerosol to direct sunlight or temperatures above 50° C
- Do not pierce or burn, even after use
- Do not spray on an open flame or any hot surfaces
- Keep away from sources of ignition - No smoking!
- Keep out of the reach of children
- Use only in well-ventilated areas
- Avoid contact with skin and eyes



Welding fixture with ceramic coating

Overview table

Item number	Designation	Weight
10,60,1,0001	Ceramic spray KRA-1000 400 ml	0,38 kg

For latest details regarding the content of this page see www.migal.co

www.migal.co

MIGAL.CO GmbH
D-94405 Landau/Isar, Wattstrasse 2
Fon +49(0)9951/69 0 59-0
Fax +49(0)9951/69 0 59-3900
Email info@migal.co